

## **Bachelor Thesis**

Diego Fonseca

# **Direct Operating Costs, Fuel Consumption, and Layout of the Airbus A321LR**

*Fakultät Technik und Informatik*

*Department Fahrzeugtechnik und  
Flugzeugbau*

*Faculty of Engineering and Computer Science*

*Department of Automotive and  
Aeronautical Engineering*

**Diego Fonseca**

**Direct Operating Costs, Fuel  
Consumption, and Cabin Layout of the  
Airbus A321 LR**

Bachelorarbeit eingereicht im Rahmen der Bachelorprüfung

im Studiengang Flugzeugbau  
am Department Fahrzeugtechnik und Flugzeugbau  
der Fakultät Technik und Informatik  
der Hochschule für Angewandte Wissenschaften Hamburg

Erstprüfer: Prof. Dr.-Ing. Dieter Scholz, MSME  
Zweitprüfer : Prof. Dr.-Ing. Gordon Konieczny

Abgabedatum: 06.12.2021

DOI:

<https://doi.org/10.15488/xxxxx>

URN:

<https://nbn-resolving.org/urn:nbn:de:gbv:18302-aero2021-12-06.014>

Associated URLs:

<https://nbn-resolving.org/html/urn:nbn:de:gbv:18302-aero2021-12-06.014>

© This work is protected by copyright

The work is licensed under a Creative Commons Attribution-NonCommercial-ShareAlike 4.0 International License: CC BY-NC-SA

<http://creativecommons.org/licenses/by-nc-sa/4.0>



Any further request may be directed to:

Prof. Dr.-Ing. Dieter Scholz, MSME

E-Mail see: <http://www.ProfScholz.de>

This work is part of:

Digital Library - Projects & Theses - Prof. Dr. Scholz

<http://library.ProfScholz.de>

Published by

Aircraft Design and Systems Group (AERO)

Department of Automotive and Aeronautical Engineering

Hamburg University of Applied Science

This report is deposited and archived:

- Deutsche Nationalbibliothek (<http://www.dnb.de>)
- Repositorium der Leibniz Universität Hannover (<http://www.repo.uni-hannover.de>)
- Internet Archive (<http://archive.org>), item: <https://archive.org/details/TextFonseca.pdf>

This report has associated published data in Harvard Dataverse:

<https://doi.org/10.7910/DVN/0QHDME>

# Abstract

**Purpose** – Assessment of the Direct Operating Costs (DOC) and fuel consumption of the Airbus A321LR using typical use-cases and comparison with those from similar aircraft. Investigation of the flexibility of the cabin layout using examples from different airlines. Calculation of Ecolabels based on different cabin configurations.

**Methodology** – All aircraft-related data is retrieved from the Original Equipment Manufacturers' (OEM) manuals. The DOC assessment uses the Association of European Airlines (AEA) and the TU Berlin method. The fuel consumption is assessed with a tool based on the Breguet Range equation, using successive iterations. The Ecolabel considers resource depletion, global warming, local air quality, and noise pollution, weighted and combined into one overall rating. A cabin study contrast layouts from Airbus with those from operators and also considering ergonomics.

**Findings** – The A321LR offers improvements in flight range compared to A321CEO and A321NEO. It can operate medium range very efficiently with only minor payload reduction. Very low-density layouts of a few airlines are purely their marketing preferences. Costs per seat and Ecolabel rating vary significantly between low-density and high-density cabin configurations. Predictions for the A321XLR are also very favorable.

**Research Limitations** – DOC results are not unique numbers but depend on the DOC method applied. Some of the characteristics for the XLR can so far only be estimated, since its entry into service is scheduled for 2023 and, as such, after the submission of this thesis.

**Practical Implications** – Good reasons for operating the A321LR are elaborated. The Ecolabel allows passengers and operators to openly discuss the ecological implications of different cabin layouts.

**Originality** – This seems to be the first scientific report that extensively investigates economic and ecologic aspects when operating the A321LR with different cabin layouts.

# Kurzreferat

**Zweck** – Ermittlung der direkten Betriebskosten (DOC) und des Treibstoffverbrauchs des Airbus A321LR anhand typischer Anwendungsfälle und Vergleich mit ähnlichen Flugzeugen. Untersuchung der Flexibilität der Flugzeugkabinenauslegungen anhand von Beispielen verschiedener Luftverkehrsgesellschaften. Berechnung von Ökolabels basierend auf verschiedenen Kabinenkonfigurationen.

**Methodik** – Alle flugzeugbezogenen Daten werden Handbüchern des Flugzeugherstellers entnommen. Für die Ermittlung der Betriebskosten werden die Berechnungsmethoden der Association of European Airlines (AEA) und der TU Berlin angewendet. Der Treibstoffverbrauch wird mit einem Werkzeug basierend auf der Breguet'schen Reichweitenformel mittels sukzessiver Iteration ermittelt. Das Ökolabel berücksichtigt Ressourcenverbrauch, globale Erwärmung, lokale Luftqualität und Lärmbelästigung, welche gewichtet und zu einer Gesamtbewertung zusammengefasst werden. Die Kabinenstudie vergleicht Flugzeugkabinenauslegungen von Airbus mit denen von Luftverkehrsgesellschaften und betrachtet ergonomische Faktoren.

**Ergebnisse** – Die A321LR bietet Verbesserungen in der Reichweite im Vergleich zur A321CEO und A321NEO. Das Flugzeug kann mit nur geringer Nutzlastreduzierung Mittelstrecken sehr effizient bedienen. Flugzeugkabinenauslegungen mit sehr geringer Dichte einiger weniger Fluggesellschaften sind reine Marketingpräferenzen. Die Kosten pro Sitzplatz und die Ergebnisse des Ökolabels variieren erheblich zwischen Kabinenkonfigurationen mit niedriger und hoher Sitzdichte. Die Vorhersagen für die A321XLR sind ebenfalls sehr positiv.

**Grenzen der Anwendbarkeit** – Betriebskosten sind keine eindeutigen Zahlen, sondern hängen von der angewendeten Methode ab. Einige der Eigenschaften des Airbus A321XLR können bisher nur geschätzt werden, da die Inbetriebnahme erst für 2023 und damit nach Abgabe dieser Arbeit geplant ist.

**Bedeutung in der Praxis** – Ein klarer Mehrwert für den Einsatz der A321LR wurde erkannt. Das Ökolabel ermöglicht es Passagieren und Luftverkehrsgesellschaften über die Auswirkungen der unterschiedlichen Flugzeugkabinenauslegungen offen zu diskutieren.

**Originalität/Wert** – Dies scheint die erste wissenschaftliche Arbeit zu sein, die ökonomische und ökologische Aspekte beim Betrieb der A321LR mit unterschiedlichen Flugzeugkabinenauslegungen umfassend untersucht.

# Direct Operating Costs, Fuel Consumption, and Cabin Layout of the Airbus A321LR

Task for a *Bachelor Thesis*

## Background

The long-range Airbus A321LR (launched in 2018) is based on the A321neo. Both aircraft belong to the popular Airbus A320 family. Although the A321LR is a rather new aircraft, it has already attracted many operators because of its versatility and long-range capabilities achieved with additional center tanks (ACT). Airlines are offered many new and attractive operating scenarios with this right-sized aircraft. Furthermore, an extended range variant, the XLR, is scheduled to be introduced in 2022, offering even more range. Inevitably, range capabilities are limited by flight physics. The A321neo already makes use of winglets for improved aerodynamics and new engines for reduced specific fuel consumption. An increased tank volume on its own improves range only in exchange for payload. On 29 April 2021 JetBlue took delivery of its first A321LR. The aircraft "has 24 lie-flat seats. The economy section is outfitted with 114 seats. The Airbus Airspace cabin - offering more comfort, mood lighting and larger luggage bins - is the first of its kind on a single-aisle aircraft" reported FlightGlobal (<https://perma.cc/F3R6-YH82>). 138 seats are not much for an A321. With reduced payload i.e., reduced number of seats, the fuel consumption per seat and the Direct Operating Costs (DOC) per seat would go up. On the other hand, the aircraft would not be so successful if its economy would not be right. For this reason, a closer look seemed necessary.

## Task

Task of this thesis is to look at fuel consumption, DOC, and cabin layout of the Airbus A321LR and A321XLR compared to the A321neo and the A330neo and/or the A350. It is important to look at the routes flown by airlines that operate the aircraft. The aircraft's cabin should be addressed particularly with a focus on its number of seats. Visualize your findings with the "bathtub curve" as explained by [Burzlaff 2017](#). You may need to build on what is given. Use the [AEA Method \(1989\)](#) and/or the [TU Berlin Method \(2013\)](#) to calculate DOCs. Compare the A321LR with competing types based on our [Ecolabel for Aircraft](#). Make use of Airbus' document "[A321 – Aircraft Characteristics Airport and Maintenance Planning](#)". The subtasks are:

- Give a brief introduction to the calculation of fuel consumption and DOC.

- Review the use or planned use of the A321LR and A321XLR with various airlines focused on long-range operations. In each case, investigate the cabin layout applied.
- Calculate and compare the fuel consumption.
- Calculate and compare the DOC.
- Calculate Ecolabels based on selected seat layouts from the OEM and typical airlines.
- Discuss the cabin design and layout of the A321LR and A321XLR in view of comfort, economy, and ecology.

The report has to be written in English based on German or international standards on report writing.

# Table of Contents

List of Figures .....	8	
List of Tables.....	12	
List of Symbols .....	16	
List of Abbreviations.....	20	
List of Definitions .....	22	
<b>1</b>	<b>Introduction .....</b>	<b>24</b>
1.1	Motivation .....	24
1.2	Objectives.....	26
1.3	Literature .....	27
1.4	Structure of the Work .....	28
<b>2</b>	<b>Fundamentals.....</b>	<b>30</b>
2.1	Aircraft Weights .....	30
2.2	Payload-Range Diagram (PRD) .....	31
2.3	Approach to the Fuel Consumption.....	33
2.3.1	Breguet Range Equation.....	33
2.3.2	Fuel Mass Calculation .....	39
2.3.3	Implementation of an Excel Tool.....	40
2.3.4	Visualization of the Fuel Consumption.....	41
2.4	Approach to the Direct Operating Costs .....	43
2.4.1	Representation of the DOC .....	45
2.4.2	Calculation of the DOCs with the AEA Method.....	47
2.4.3	Calculation of the DOC with the TU Berlin Method .....	60
2.4.4	Implementation of Excel Tools .....	63
2.4.5	Visualization of the Direct Operating Costs.....	64
2.5	Flight Haul.....	65
2.6	Aircraft Considered for Comparisons .....	66
2.7	Use Cases or Missions Considered .....	68
2.8	Passenger Mass Considered .....	72
<b>3</b>	<b>Fuel Consumption of the Airbus A321LR .....</b>	<b>73</b>
3.1	Assessment of the Fuel Consumption .....	73
3.1.1	Bathtub Curve.....	73
3.1.2	Fuel per Range over Range .....	75
3.1.3	Total Fuel over Range .....	76
3.2	Comparison with Other Aircraft.....	76



<b>4</b>	<b>Direct Operating Costs of the Airbus A321LR</b> .....	86
4.1	Introduction .....	86
4.2	Assessment of the DOC .....	87
4.2.1	M1 – 5600 km .....	87
4.2.2	M2 – 6500 km .....	93
4.2.3	M3 – 7400 km .....	97
4.3	Comparison with Other Aircraft.....	100
4.3.1	M1 – 5600 km .....	101
4.3.2	M2 – 6500 km .....	107
4.3.3	M3 – 7400 km .....	112
<b>5</b>	<b>Ecolabel Applied to the Airbus A321LR</b> .....	118
5.1	Introduction, History, and Launch of the Ecolabel .....	118
5.2	Ecolabel Assessment of the A321 LR.....	122
5.3	Ecolabel Assessment of the Other Aircraft Used for Comparison.....	127
<b>6</b>	<b>Cabin Layout of the Airbus A321LR</b> .....	129
6.1	Introduction and General Considerations.....	129
6.2	Seat Pitch versus Ergonomic Assessment of the Cabin Layouts Employed by the A321LR Operators .....	130
6.3	Seat Width and General Impact of the Cabin Layouts.....	132
6.4	Exemplary Seat Layouts for the A321LR: Airbus vs. Airlines.....	134
6.5	Cross Section and Aisle Configurations of the A321LR According to Airbus...	137
<b>7</b>	<b>Discussion of the Results</b> .....	139
7.1	General Considerations and Critic .....	139
7.2	Fuel Consumption .....	139
7.3	Direct Operating Costs .....	143
7.4	Ecolabel.....	149
7.5	Cabin Layout .....	151
<b>8</b>	<b>Summary and Conclusions</b> .....	153
	<b>List of References</b> .....	156
	<b>Appendix A – User Interface of the Excel Tool Used for Fuel Calculation</b> .....	165
	<b>Appendix B – DOC Methods and Corresponding Organizations</b> .....	166
	<b>Appendix C – Interface of the Tools Used for the DOC Calculation</b> .....	167
	<b>Appendix D – Payload-Range Diagrams for the A321 Family and the A330-900neo</b> ...	169
	<b>Appendix E – Overview of the Different A321neo Versions (neo and LR): MTOW, MZFW, and MFW</b> .....	171

<b>Appendix F – Estimates for the A321XLR .....</b>	<b>172</b>
<b>Appendix G – Fuel Consumption of the Aircraft used for Comparison.....</b>	<b>173</b>
<b>Appendix H – Summary of the DOCs: All Missions.....</b>	<b>175</b>
<b>Appendix I – FAA: Emissions and Implications .....</b>	<b>181</b>
<b>Appendix J – Ecolabels for Other A321LR Operators.....</b>	<b>182</b>
<b>Appendix K – Anthropometrical Data from the NCSU .....</b>	<b>183</b>

## List of Figures

<b>Figure 2.1</b>	Generic payload-range diagram (Scholz 2015) .....	31
<b>Figure 2.2</b>	Extended payload-range diagram, based on Young (2017, pp. 420).....	31
<b>Figure 2.3</b>	Payload-range diagram accounting the fuel reserves and the fuel fractions; based on Young (2017, pp. 420).....	32
<b>Figure 2.4</b>	Payload-range diagram with strategic points for the Breguet Factor calculation; based on Young (2017, pp. 420) .....	37
<b>Figure 2.5</b>	User interface of the fuel calculation tool (Burzlaff 2017; Scholz (2021a)...	40
<b>Figure 2.6</b>	Fuel consumption: fuel per range over range visualization (generated with Scholz 2021a) .....	41
<b>Figure 2.7</b>	Fuel consumption: fuel per range over range visualization (generated with Scholz (2021a) .....	42
<b>Figure 2.8</b>	Fuel consumption: fuel over range visualization (generated with Scholz (2021a) .....	42
<b>Figure 2.9</b>	Overview of different cost methods: calculation methods for the DOC (Scholz 2015) – see Appendix B.....	43
<b>Figure 2.10</b>	Relationship between cost assessment methods .....	44
<b>Figure 2.11</b>	Development of the fuel price from 1980 to 2021. Source: U.S. Energy Information Administration (EIA 2021).....	51
<b>Figure 2.12</b>	Definition of the flight mission according to AEA 1989b (long-range). (Scholz 2015) .....	52
<b>Figure 2.13</b>	Relative aircraft utilization calculated according to Eqn. (2.82) (Scholz 2015) .....	60
<b>Figure 2.14</b>	User interface of the PreSTo tool for calculating DOCs with the AEA method (Scholz 2021b).....	64
<b>Figure 2.1</b>	User interface of own tool for calculating DOCs with the TU Berlin method.....	64
<b>Figure 2.16</b>	DOC distribution visualization (Scholz 2021b) .....	65
<b>Figure 2.17</b>	Destination airports departing from EWR within a 5.600 km flight radius (GoogleEarth Pro 2021).....	68
<b>Figure 2.18</b>	Destination airports departing from EWR within a 6.500 km flight radius (GoogleEarth Pro 2021).....	69
<b>Figure 2.19</b>	Destination airports departing from LIS within a 7.400 km flight radius (GoogleEarth Pro 2021).....	70
<b>Figure 2.20</b>	Top ten A321 routes between Europe and North America in 2021, according to number of flights (Pearson 2021b) .....	71
<b>Figure 3.1</b>	Fuel consumption per range and passenger over flown distance for the A321LR – bathtub curve.....	74
<b>Figure 3.2</b>	Fuel consumption per range over flown distance for the A321LR – all cabin layouts .....	75

<b>Figure 3.3</b>	Fuel consumption over flown distance for the A321LR – all cabin layouts.76
<b>Figure 3.4</b>	Comparison of fuel consumption per range and passenger over the flown distance all the considered aircraft: standard density cabin; indicated minima ..... 77
<b>Figure 3.5</b>	Comparison of fuel consumption per range and passenger over the flown distance all the considered aircraft: low-density cabin; indicated minima...78
<b>Figure 3.6</b>	Comparison of fuel consumption per range and passenger over the flown distance all the considered aircraft: high-density cabin; indicated minima...80
<b>Figure 3.7</b>	Comparison of fuel consumption per range and passenger over flown distance between the A321LR and the A321XLR – various cabin layouts..... 81
<b>Figure 3.8</b>	Comparison of the fuel consumption per range and passenger over flown distance between the A321LR and the A321neo – various cabin layouts... 81
<b>Figure 3.9</b>	Comparison of fuel consumption per range and passenger over flown distance between the A321LR and the A330-900neo – various cabin layouts..... 82
<b>Figure 3.10</b>	Comparison of fuel consumption per range over flown distance within the A321 family ..... 83
<b>Figure 3.11</b>	Comparison of fuel consumption per range over flown distance between the A321LR and the A330-900neo ..... 83
<b>Figure 3.12</b>	Comparison of fuel consumption over the flown distance within the A321 family ..... 84
<b>Figure 3.13</b>	Comparison of fuel consumption over the flown distance between the A321LR and the A330-900neo ..... 85
<b>Figure 5.1</b>	Passenger number development registered by Swedavia between 2017 and 2019 (Hervey-Bathurst 2019) ..... 118
<b>Figure 5.2</b>	Ecolabel: exemplary distribution of the impact categories – unweighted. 120
<b>Figure 5.3</b>	Ecolabel: exemplary distribution of the impact categories – weighted..... 120
<b>Figure 5.4</b>	Flyer explaining the Ecolabel to the general public or passengers (Hurtecant 2021) ..... 122
<b>Figure 5.5</b>	Ecolabel for the Airbus A321LR: Airbus standard configuration ..... 123
<b>Figure 5.6</b>	Ecolabel for the Airbus A321LR: Air Transat..... 124
<b>Figure 5.7</b>	Ecolabel for the Airbus A321LR: TAP Air Portugal..... 125
<b>Figure 5.8</b>	Ecolabel for the Airbus A321LR: JetBlue ..... 126
<b>Figure 5.9</b>	Ecolabel for the A321ceo: Airbus std. configuration ..... 127
<b>Figure 5.10</b>	Ecolabel for the A321neo: Airbus std. configuration ..... 127
<b>Figure 5.11</b>	Ecolabel for the A330-900neo: Airbus standard configuration..... 128
<b>Figure 6.1</b>	Installation of seat rows in the seat rails, example (Walton 2016) ..... 129
<b>Figure 6.2</b>	Passenger aircraft cabin with removed seats (Andrew 2020)..... 129
<b>Figure 6.3</b>	Seat pitch 31” (Honig 2018) ..... 130
<b>Figure 6.4</b>	Seat pitch 34” (Honig 2018) ..... 130
<b>Figure 6.5</b>	Seat pitch (A) and legroom (B) (Kremser et al. 2012) – the clearance at knee height is equal to the legroom minus the BKL. .... 131
<b>Figure 6.6</b>	Anthropometric measurements while seating (Gosende 2017) ..... 131

<b>Figure 6.7</b>	JetBlue Mint Studio – business class (JetBlue 2021b) .....	133
<b>Figure 6.8</b>	JetBlue coach seats – economy class (JetBlue 2021b) .....	133
<b>Figure 6.9</b>	Seat layout of A321LR: Airbus standard configuration, single class (Airbus 2020) .....	135
<b>Figure 6.10</b>	Seat layout for the A321LR: .....	136
<b>Figure 6.11</b>	Seat Layout for A321neo* .....	136
<b>Figure 6.12</b>	A321LR cross-section: 6 seat abreast – wider aisle (Airbus 2020) .....	137
<b>Figure 6.13</b>	A321LR cross-section: 6 seat abreast – wider seat (Airbus 2020) .....	137
<b>Figure 6.14</b>	A321LR cross-section: 4 seats abreast – first-class (Airbus 2020) .....	138
<b>Figure 7.1</b>	Comparison of the fuel consumption per range and passenger over the flown distance between the A321ceo and the A321LR – 200 pax .....	142
<b>Figure 7.2</b>	Yearly DOCs and SKCs of the A321LR with the TUB Method: all missions and cabin configurations .....	144
<b>Figure 7.3</b>	DOC distribution for the A321LR in M1, M2, and M3: low-density cabin configuration, without additional cargo – TUB Method .....	146
<b>Figure 7.4</b>	DOC distribution for the A321LR in M1, M2, and M3: low-density cabin configuration, without additional cargo – AEA Method .....	146
<b>Figure 7.5</b>	DOC comparison: standard .....	147
<b>Figure 7.6</b>	DOC comparison: high-density .....	147
<b>Figure 7.7</b>	DOC comparison: low-density .....	147
<b>Figure 7.8</b>	DOC comparison: low-density .....	147
<b>Figure 7.9</b>	SKC comparison: standard .....	148
<b>Figure 7.10</b>	SKC comparison: high-density .....	148
<b>Figure 7.11</b>	SKC comparison: low-density .....	149
<b>Figure 7.12</b>	SKC comparison: low-density .....	149
<b>Figure A.1</b>	Input, calculation and output of the fuel calculation tool: MTOW, MZFW, MPL, MFW, OEM, Seat-Passengers, $m_{pax}$ and Mach in cruise. (Scholz 2021a). .....	165
<b>Figure C.1</b>	Input for the PreSTo tool: aircraft masses, fuel mass, passenger mass, and take-off thrust (Scholz 2021b) .....	167
<b>Figure C.2</b>	Output of the PreSTo tool: yearly DOC, DOC composition, and various cost interpretations, e.g., SKC (Scholz 2021b) .....	167
<b>Figure C.3</b>	Output of the own developed tool for the computation of the DOCs according to the TU Berlin DOC method: route-independent costs .....	168
<b>Figure C.4</b>	Output of the own developed tool for the computation of the DOCs according to the TU Berlin DOC method: route-dependent costs .....	168
<b>Figure D.1</b>	PRD for A321neo variants: MTOW, MPL, ranges (B, C, and D) – edited from Airbus (2020) .....	169
<b>Figure D.2</b>	PRD for the A321-200 variants: MTOW, MPL, and ranges – edited from Airbus (2020) .....	169
<b>Figure F.1</b>	Estimated PRD for the Airbus A321XLR; edited from Airbus (2020) .....	172

<b>Figure G.1</b>	Fuel consumption per range and passenger over the flown distance for the A321neo – Bathtub Curve .....	173
<b>Figure G.2</b>	Fuel consumption per range and passenger over flown the distance for the A321XLR – Bathtub Curve .....	173
<b>Figure G.3</b>	Fuel consumption per range and passenger over the flown distance for the A330-900neo – Bathtub Curve .....	174
<b>Figure J.1</b>	Ecolabel for the A321LR – Aer Lingus; generated with Hurtecant (2021); based on SeatGuru (2021d).....	182
<b>Figure J.2</b>	Ecolabel for the A321LR – Air Astana; generated with Hurtecant (2021); based on Air Astana (2021) .....	182

## List of Tables

<b>Table 2.1</b>	Fuel fraction on horizontal and non-horizontal flight phases .....	36
<b>Table 2.2</b>	Range, take-off, and landing weights for strategic points in the payload-range.....	38
<b>Table 2.3</b>	Standardized assumed time difference between block time and flight time .....	47
<b>Table 2.4</b>	Parameters for the calculation of depreciation.....	48
<b>Table 2.5</b>	Parameters for the calculation of the average interest rate $p_{av}$ .....	50
<b>Table 2.6</b>	Flight crew costs per hour in short and medium-range flight: AEA method; based on Scholz (2015).....	57
<b>Table 2.7</b>	Parameters for the calculation of fees and taxes.....	58
<b>Table 2.8</b>	Parameters for the calculation of the aircraft utilization according to Eqn. (2.82).....	60
<b>Table 2.9</b>	Weights and ranges of the considered aircraft.....	67
<b>Table 2.10</b>	Scheduled long-haul flights operated by A321LR aircraft – winter season 2021/22 (edited from Pearson 2021a).....	71
<b>Table 4.1</b>	Payload and trip fuel for the DOC calculation, A321LR – M1 with/without additional cargo.....	87
<b>Table 4.2</b>	General values for the DOC computation of the A321LR with/without cargo – M1: 160 pax .....	89
<b>Table 4.3</b>	DOC for the A321LR in M1 for different cabin configurations, with additional cargo – TUB.....	89
<b>Table 4.4</b>	DOC for the A321LR in M1 for different cabin configurations, without additional cargo – TUB.....	90
<b>Table 4.5</b>	DOC for the A321LR in M1 for different cabin configurations, with additional cargo – AEA .....	91
<b>Table 4.6</b>	DOC for the A321LR in M1 for different cabin configurations, without additional cargo – AEA .....	91
<b>Table 4.7</b>	Payload and trip fuel for the DOC calculation, A321LR – M2, with/without additional cargo.....	93
<b>Table 4.8</b>	General values for the DOC computation of the A321LR – M2, with/without cargo: 160 pax.....	94
<b>Table 4.9</b>	DOC for the A321LR in M2 for different cabin configurations, with additional cargo – TUB.....	94
<b>Table 4.10</b>	DOC for the A321LR in M2 for different cabin configurations, without additional cargo – TUB.....	95
<b>Table 4.11</b>	DOC for the A321LR in M2 for different cabin configurations, with additional cargo – AEA .....	96
<b>Table 4.12</b>	DOC for the A321LR in M2 for different cabin configurations, without additional cargo – AEA .....	96

<b>Table 4.13</b>	Payload and trip fuel for the DOC calculation, A321LR – M1, with/without additional cargo.....	97
<b>Table 4.14</b>	General values for the DOC computation, A321LR – M3, with/without additional cargo: 160 pax.....	98
<b>Table 4.15</b>	DOC for the A321LR in M3 for different cabin configurations, with additional cargo – TUB.....	98
<b>Table 4.16</b>	DOC for the A321LR in M3 for different cabin configurations, without additional cargo – TUB.....	99
<b>Table 4.17</b>	DOC for the A321LR in M3 for different cabin configurations, with additional cargo – AEA .....	99
<b>Table 4.18</b>	DOC for the A321LR in M3 for different cabin configurations, without additional cargo – AEA .....	100
<b>Table 4.19</b>	DOC comparison between the A321LR and similar aircraft: M1 – standard density cabin, with add. cargo.....	101
<b>Table 4.20</b>	DOC comparison between the A321LR and similar aircraft: M1 – standard density cabin, without add. cargo .....	103
<b>Table 4.21</b>	DOC comparison between the A321LR and similar aircraft: M1 – high-density cabin, with additional cargo.....	104
<b>Table 4.22</b>	DOC comparison between the A321LR and similar aircraft: M1 – high-density cabin, without add. cargo.....	105
<b>Table 4.23</b>	DOC comparison between the A321LR and similar aircraft: M1 – low-density cabin, with additional cargo.....	106
<b>Table 4.24</b>	DOC comparison between the A321LR and similar aircraft: M1 – low-density cabin, without additional cargo.....	106
<b>Table 4.25</b>	DOC comparison between the A321LR and similar aircraft: M2 – standard density cabin, with add. cargo.....	108
<b>Table 4.26</b>	DOC comparison between the A321LR and similar aircraft: M2 – standard density cabin, without add. cargo .....	109
<b>Table 4.27</b>	DOC comparison between the A321LR and similar aircraft: M2 – high-density cabin, with add. cargo.....	110
<b>Table 4.28</b>	DOC comparison between the A321LR and similar aircraft: M2 – high-density cabin, without add. cargo.....	110
<b>Table 4.29</b>	DOC comparison between the A321LR and similar aircraft: M2 – low-density cabin, with additional cargo.....	111
<b>Table 4.30</b>	DOC comparison between the A321LR and similar aircraft: M2 – low-density cabin, without add. cargo .....	112
<b>Table 4.31</b>	DOC comparison between the A321LR and similar aircraft: M3 – standard density cabin, with add. cargo.....	113
<b>Table 4.32</b>	DOC comparison between the A321LR and similar aircraft: M3 – standard density cabin, without add. cargo .....	114
<b>Table 4.33</b>	DOC comparison between the A321LR and similar aircraft: M3 – high-density cabin, with additional cargo.....	115



<b>Table 4.34</b>	DOC comparison between the A321LR and similar aircraft: M3 – high-density cabin, without add. cargo .....	115
<b>Table 4.35</b>	DOC comparison between the A321LR and similar aircraft: M3 – low-density cabin, with additional cargo .....	116
<b>Table 4.36</b>	DOC comparison between the A321LR and similar aircraft: M3 – low-density cabin, without add. cargo .....	117
<b>Table 6.1</b>	Legroom for the considered percentiles: 29” and 34” seat pitch .....	132
<b>Table 6.2</b>	Cabin configuration, seat pitch, and seat width for different airlines (measurements in inch) – (Airbus 2020; SeatGuru 2021a, 2021d, 2021b; Air Astana 2021 and JetBlue 2021b) .....	133
<b>Table 7.1</b>	Overall fuel consumption evaluation regarding the cabin configurations of the A321LR by different airlines .....	140
<b>Table 7.2</b>	Specific fuel consumption and specific CO <sub>2</sub> emissions of the Lufthansa Group (2020) in 2020.....	143
<b>Table 7.3</b>	Comparison of $EI_{NOx}$ between the EEA emission calculator and the Ecolabel.....	150
<b>Table B.1</b>	Overview of selected DOC methods and corresponding organizations (Scholz 2015).....	166
<b>Table E.1</b>	Characteristics of A321neo variants: MTOW, MZFW – specific to each weight variant; edited from Airbus (2020) .....	171
<b>Table E.2</b>	Characteristics of the A321-100, A321-200 and A321neo variants: ACTs and MFW – common to each weight variant ; edited from Airbus (2020) .....	171
<b>Table H.1</b>	DOC overview for all missions: TUB method, standard cabin with add. cargo.....	175
<b>Table H.2</b>	DOC overview for all missions: TUB method, standard cabin without add. cargo.....	175
<b>Table H.3</b>	DOC overview for all Missions: TUB method, high-density cabin with add. cargo.....	176
<b>Table H.4</b>	DOC overview for all missions: TUB method, high-Density cabin without add. cargo.....	176
<b>Table H.5</b>	DOC overview for all missions:TUB method, low-density cabin with add. cargo.....	177
<b>Table H.6</b>	DOC overview for all Missions: TUB method, low-density cabin without add. cargo.....	177
<b>Table H.7</b>	DOC overview for all missions: AEA method, standard cabin with add. cargo.....	178
<b>Table H.8</b>	DOC overview for all missions: AEA method, standard Density without add. cargo.....	178
<b>Table H.9</b>	DOC overview for all missions: AEA method, high-density cabin with add. cargo.....	179
<b>Table H.10</b>	DOC overview for all missions: AEA method, high-density cabin without add. cargo.....	179

<b>Table H.11</b>	DOC overview for all missions: AEA method, low-density cabin with add. cargo.....	180
<b>Table H.12</b>	DOC overview for all missions: AEA method, low-density cabin without add. cargo.....	180
<b>Table I.1</b>	Aviation-related emissions (FAA 2015) .....	181
<b>Table K.1</b>	Buttock-Popliteal Length for female and male percentiles of the American population (Ergocenter NCSU 2021).....	183
<b>Table K.2</b>	Buttock-Knee Length for female and male percentiles of the American population (Ergocenter NCSU 2021).....	184

## List of Symbols

$a$	Average interest
$B$	Breguet factor
$BT$	Block time supplement per flight
$Burden$	Cost burden
$c$	Specific fuel consumption
$C_1$	Route independent (fixed) costs
$C_2$	Route dependent (variable) costs
$C_{a/c, a}$	Annual aircraft costs
$C_{a/c, m}$	Aircraft mile costs
$C_{a/c, t}$	Aircraft trip costs
$CC$	Cabin crew complement
$C_C$	Crew costs
$C_{C, CA}$	Cabin crew costs
$C_{C, CO}$	Cockpit crew costs
$C_{CAP}$	Capital costs
$C_{CREW}$	Crew costs
$C_{DEP}$	Depreciation costs
$C_{DOC}$	Direct Operating Costs (value)
$C_F$	Fuel costs
$C_{FEE}$	Fees and charges costs
$C_{FEE, GND}$	Ground handling fees
$C_{FEE, LD}$	Landing fees
$C_{FEE, NAV}$	Navigation charges
$C_{INS}$	Insurance costs
$C_{INT}$	Interest costs
$C_M$	Maintenance costs
$C_{M, f}$	Maintenance costs per flight
$C_{M, L}$	Labor costs
$C_{M, M}$	Material costs for maintenance
$C_{M, M, a}$	Maintenance costs per year
$C_{M, M, AF, f}$	Material costs per flight for the airframe maintenance
$C_{M, M, E, f}$	Material costs per flight for the engine maintenance
$C_{M, M, f}$	Material costs per flight for maintenance
$C_{pax, t, m}$	Aircraft seat-ton-mile costs
$C_{s, m}$	Aircraft seat-mile costs
$C_{t, m}$	Aircraft ton-mile costs
$D$	Drag coefficient
$DP$	Depreciation period
$DT_{p, a}$	Yearly forced downtime

$E$	Glide ratio
$f(R)$	Range dependent air traffic control price factor
$FC$	Yearly flight-cycles
$f_{Ins}$	Insurance rate
$f_{RV}$	Residual value factor
$FT$	Flight time
$g$	Gravity acceleration
$IR$	Interest rate
$k_0$	Initial price
$k_1$	Take-off thrust calculation factor $k_1$
$k_2$	Take-off thrust calculation factor $k_2$
$k_3$	Take-off thrust calculation factor $k_3$
$k_4$	Take-off thrust calculation factor $k_4$
$k_E$	Engine type constant
$k_{GND}$	Ground handling factor
$k_{INF}$	Inflation factor
$k_{INS}$	Insurance factor
$k_{LD}$	Landing factor
$k_{NAV}$	Navigation factor
$k_{thr}$	Reverse thrust constant
$k_{U1}$	Parameter $k_{U1}$ for calculation of the aircraft utilization
$k_{U2}$	Parameter $k_{U2}$ for calculation of the aircraft utilization
$L$	Lift coefficient
$L_{CA}$	Mean hourly payment for cabin crew
$L_{CO}$	Mean hourly payment for cockpit crew
$L_M$	Hourly maintenance rate
$LR$	Labor rate
$m$	Mass
$m_1$	Initial mass
$m_2$	Final mass
$m_{AF}$	Mass of Airframe
$m_{baggage}$	Baggage Mass
$MC$	Maintenance cost per flight cycle
$MC_{AF,MAT}$	Airframe material maintenance costs
$MC_{AF,PER}$	Airframe personnel maintenance cost
$MC_{ENG}$	Engine total maintenance costs
$m_E$	Mass of one engine without parts used for engine integration
$m_{E,inst}$	Mass of all engines on aircraft
$m_f$	Fuel mass
$m_F$	Mass of fuel consumed during flight
$M_{ff}$	Fuel fractions (total)
$M_{ff,C1b}$	Fuel fraction for climb phase

$M_{ff,Cr}$	Fuel fraction for cruise phase
$M_{ff,Des}$	Fuel fraction for descent phase
$M_{ff,Ldg}$	Fuel fraction for landing phase
$M_{ff,Loi}$	Fuel fraction for loiter phase
$M_{ff,LTO}$	Fuel Fractions for the non-horizontal flight phases
$M_{ff,Res}$	Fuel fraction for fuel reserve
$M_{ff,ShutOff}$	Fuel fraction for shut-off
$M_{ff,To}$	Fuel fraction for take-off phase
$m_{fuel}$	Burned fuel mass
$m_{MTO}$	Maximum take-off mass
$m_{OE}$	Operating empty mass
$m_{pax}$	Passenger mass
$m_{PL}$	Payload mass
$N$	Newton
$n$	see $n_{PAY}$
$n_C$	Number of compressor stages – including fan
$n_{CA}$	Number of cabin crew
$n_{CO}$	Number of cockpit crew
$n_{DEP}$	Useful service life of item
$n_E$	Number of engines
$N_{Eng}$	see $n_E$
$N_{FA}$	Number of flight attendants
$n_{method}$	Year to which the method refers to
$n_{pax}$	Number of passengers
$n_{PAY}$	Number of repayment years
$n_s$	Number of shafts of the engine
$n_{t,a}$	Total number of flight-cycles per year
$n_{t,d}$	Total number of flight-cycles per day
$n_{t,h}$	Total number of flight-cycles per hour
$n_{year}$	Year for which calculation is made
$OT_{p,a}$	Yearly operation time
$P_{AF}$	Price of airframe
$P_{av}$	Average interest rate
$P_{delivery}$	Delivery price
$P_E$	Price of engines
$P_{Eng}$	Price per engine weight
$P_F$	Fuel price
$P_{INF}$	Annual mean inflation rate
$P_L$	Landing fees
$PL$	Payload
$P_{OEW}$	Price per kilogram of operating empty weight
$POT_{p,a}$	Potential yearly operation time

$P_{PL}$	Handling fees
$P_{residual}$	Residual value
$P_S$	Price of spare parts
$P_{total}$	Total purchase price of aircraft
$Q$	Fuel mass flow
$Q_{Jet}$	Fuel mass flow for engine powered aircraft
$R$	Range/average stage length (p.57 - fórmula 2.96)
$S_{FA}$	Average yearly salary of a flight attendant
$S_{FC}$	Average yearly salary of a cockpit crew
$SLST$	Sea level static thrust of one engine
$t$	Time
$t_b$	Block time
$t_f$	see FT
$TF$	Trip fuel
$t_M$	Maintenance hours
$t_{M,a}$	Maintenance hours per year
$t_{M,AF,f}$	Airframe maintenance hours per flight
$t_{M,E,f}$	Engine maintenance hours per flight
$t_{M,f}$	Maintenace man-hours per flight
$T_{T/O,E}$	Take-off thrust of one engine
$U$	Aircraft utilization
$U_{a,b}$	Annual aircraft utilization in relation to block time
$U_{a,f}$	Annual aircraft utilization in relation to flight time
$U_{d,b}$	Daily aircraft utilization in relation to block time
$U_{d,f}$	Daily aircraft utilization in relation to flight time
$U_{h,b}$	Hourly aircraft utilization in relation to block time
$U_{h,f}$	Hourly or relative aircraft utilization in relation to flight time
$V$	Cruise speed
$w$	Weight
$W_{Eng}$	Weight per engine

## Greek Symbols

$\Delta m_f$	Fuel mass variation
$\Delta m$	Mass Variaton
$\Delta t$	Time difference

## List of Abbreviations

A321LR	Airbus A321 Long Range
A339	Airbus A330-900neo
ACT	Additional Center Tank
AEA	Association of European Airlines
AKC	Aircraft-Kilometer Costs
APU	Auxiliary Power Engines
ATA	Air Transport Association
ATC	Air Traffic Control, Air Traffic Control
B/C	Business Class
BH	Block Hour
BKL	Buttock-Knee Length
BPL	Buttock-Popliteal Length
BPR	Bypass Ratio
BR	Breguet Range, Brazil
BW	Basic Weight
CCQ	Cross Crew Qualification
ceo	Current Engine Option
COC	Cash Operating Costs
COO	Cost of Ownership
COP26	Convention of Parties – 26th Edition
DMC	Direct Maintenance Costs
DOC	Direct Operating Costs
DOW	Dry Operating Weight
EASA	European Union Aviation Safety Agency
EI <sub>NOx</sub>	Emission Index of Nitrogen Oxides
EPNdB	Effective Perceived Noise in Decibels
EPNL	Effective Perceived Noise Level
EPRD	Extended Payload Range Diagram
F/C	First Class
FC	Flight Cycles
FH	Flight Hours
HOOU	Hamburg Open Online University
IFE	In-Flight Entertainment
IMC	Indirect Maintenance Costs
IOC	Indirect Operating Costs
LAP	Local Air Pollution
LCC	Life-Cycle Costs
LRU	Line Replaceable Units

MEW	Manufacturer's Empty Weight
MFW	Maximum Fuel Weight
MPL	Maximum Payload
MTOW	Maximum Take-Off Weight
MZFW	Maximum Zero Fuel Weight
neo	New Engine Option
NM	Nautical Miles
OAPR.	Overall Pressure Ratio
OEM	Original Equipment Manufacturer
OEW	Operating Empty Weight
p.a.	per annum
pax	Passengers
PRD	Payload-Range Diagram
PT	Portugal
RCT	Rear Center Tank
SKC	Seat-Kilometer Costs
SMC	Seat-Mile Costs
TOC	Total Operating Costs
TOW	Take-off Weight
TSFC	Thrust-Specific Fuel Consumption
TUB	Technical University of Berlin
WC	Water Closet
WHO	World Health Organization
XLR	Extra Long Range
Y/C	Economy Class
yr	Year
ZFW	Zero Fuel Weight



# List of Definitions

## Direct Operating Costs (DOC)

*“... those costs incurred in operating the aircraft which cover the following main accounts: flight operations, flight equipment maintenance and overhaul, flight equipment depreciation, and user charges.” (ICAO 2020)*

## Fuel Consumption

*“... is the rate at which an engine uses fuel, expressed in units such as miles per gallon or liters per kilometer.” (CollinsDictionary 2021)*

## Ecolabel

*“... is a label which identifies overall environmental preference of a product or service within a specific product/service category based on life cycle considerations.” (Environmental Choice 2021)*

## Cabin Layout

The arrangement of the passenger seats, WCs, and galleys along the aircraft’s cabin.

## Legacy Carrier

*“Major air transport operators (flag carriers) owning and/or operating the largest air network(s) in each country.” (ICAO 2020)*

## Low-cost carrier

*“... an airline that offers lower fares than traditional airlines, reflecting limited service provision, while also charging additional fees for on-board and airport services.” (Aeroflot 2020)*

## Available Seat Kilometer

*“... a measure of an airline’s carrying capacity to generate revenue, taken from multiplying the available seats on any given aircraft by the number of kilometres flown on a given flight.” (Aeroflot 2020):*

## Payload

*“The weight of passengers, baggage, cargo and mail and includes both revenue and non-revenue items.” (IATA 2018)*

**Decimal and Thousands Separator**

The symbol used for the decimal representation in numbers is “,” (comma). The symbol “.” (period) is used for the separation of thousands in numbers.

**Distance and Length**

The main unit of distance or length employed is the metric system, i.e., meter [m] and its derivatives (multiples and submultiples) – especially kilometers [km = 1000 m]. Following conversions apply:

1 statute mile = 1,6093 kilometers

1 nautical mile = 1,853 kilometers

1 kilometer = 0,6214 statute miles

1 kilometer = 0,5396 nautical miles

# 1 Introduction

## 1.1 Motivation

The A321LR was launched in 2018 as an extended-range variant based on the A321neo (New Engine Option). In other words, this implies that this aircraft can cover longer distances than the previous generations of its descending A320 family. According to Airbus (2019a):

*“... With a range of up to 4,000 NM (7,400 km), the A321LR is the unrivalled long-range route opener, featuring true transatlantic capability and premium wide-body comfort in a single-aisle aircraft cabin.”*

Aside from the fuselage – with a Sharklet™ wingtip device winglet for improved aerodynamics – the LR also shares the same engines as the A321neo (CFM LEAP-1A or PW-1100G), which represent a substantial improvement in terms of noise pollution, **fuel consumption**, and, not less critical, **gaseous emissions** compared to the predecessor aircraft, so that the original equipment manufacturer (OEM), Airbus (2019a), advertises the LR with:

*“...It [A321LR] delivers 30% fuel savings and nearly 50% reduction in noise footprint compared to previous-generation competitor aircraft.”*

The LR figures three additional center tanks (ACT), which, coupled with the engines' more efficient fuel consumption, make it possible to fly longer ranges – e.g., around 1000 NM more than the first generations of the A321 and 500 NM more than the neo.

However, the ACT consequently translates into additional fuel to be transported, which is lastly limited by structural (fuselage) aspects, i.e., implying a reduced maximum payload (passengers) if corresponding measures are not taken. This should mean that the airlines could fly longer, although also at the cost of transporting fewer passengers. In this case, it is a valid ponderation whether to invest in the LR or not. For example, JetBlue, which received its first LR on April 29<sup>th</sup>, 2021, showcases a cabin layout with a total of 138 seats, which is a low number of seats for such an aircraft nowadays (JetBlue 2021a and Airbus 2021a). For comparison, most A321neo or similar aircraft generally fly with a mean between 180-220 passengers. Amongst others, a reduction of passengers means a higher **cost per seating passenger** for a given flight, which would necessarily reflect in the ticket price.

Nevertheless, various airlines and aviation magazines still assure that the LR is capable of offering great **cabin flexibility**, thus allowing airlines to employ cabin configurations that fit their needs in the best way possible. A simple look at the OEMs manual shows that the maximum seating passengers of the neo and LR are indeed very similar – with a standard cabin configuration of 206 in a 2 class seating layout – contradicting the postulations of the previous paragraph (Airbus 2020).

In fact, the A321LR has experienced crescent popularity and commitment since its launch, which has converted into a significant amount of orders, for example, from TAP Air Portugal (12), JetBlue (13), Air Astana, and others (Airbus 2021a) – the starting price for the base A321neo variant was 129 M US\$ per aircraft in 2018 (Airbus 2019b). Furthermore, the same airlines and magazines continuously praise the LR for the engineering and technology implementation, e.g., according to Robert Hayes, chief executive of JetBlue:

*“The A321LR platform... is the right size for us and will allow to us to effectively compete without award-winning service and low fares on flights between the US and London.” (Wolfsteller 2021)*

In addition, pilots and cabin crew who already operate the aircraft of the A320 family only need transition training to use the LR due to the family commonality – Cross Crew Qualification (CCQ). This fact attracts airlines even more since most of them already operate an aircraft of the A320 family or similar. The A320neo and its derivatives are the world’s best-selling single-aisle aircraft family with over 7450 firm orders, including around 3679 A321neo variants, as of October 2021 (Airbus 2019c; Airbus 2021b).

Single-aisles aircraft like the A321LR typically serve different purposes than twin-aisles like the Airbus A350 or A380 and the Boeing B747 or B777. Along with varying cabin dimensions and aircraft mass, the flight range in which these two aircraft categories operate is usually distinguished, even though both types of aircraft are mostly capable of flying long-range missions to a certain extent. In these cases the critical factor is that, twin-aisles aircraft are obviously capable of transporting more passengers. Therefore, a good ratio between the number of passengers and the flight distance shall exist, in order to operate the aircraft productively.

Generally, single-aisle operate “shorter” flights and are thus capable of operating more flights per day while transporting relatively less passengers. On the other hand, the business strategy of the twin-aisles consists of transporting as many passengers as possible in larger distances (seven hours or more), implying fewer flights per day. Therefore it is a question of market strategy for the airlines to choose which sort of routes and how they want to operate. With its range capabilities, the LR allows breaking through this logic and offering more options to its operators, since it can be employed not only in medium but also in long-haul segments, i.e., with a flight duration greater than six hours.

In the past years, a consolidation of twin-engine aircraft in upper medium-haul to long-haul routes has been observed as airlines bet on reliable and constant connections between international hubs (Hardiman 2020). This is possible due to considerable improvements in the fields of aerodynamics and engines, allowing aircraft to fly longer and more efficiently. Furthermore, operating a larger aircraft is riskier if the expected occupancy rate of seats is not guaranteed since larger aircraft have higher operating costs per flight. Particularly in a pandemic situation, like the COVID-19, it has become clear for airlines which implications the inability to have an acceptable occupancy rate has. Another vivid example of the risks associated with

developing and operating larger aircraft is the early termination of the Airbus A380 program with less than 25% of the predicted aircraft manufactured, mainly due to lack of orders (Riley 2019). This may show that operating super-sized aircraft may not be the path to follow, at least for now.

Having had such positive feedback from the LR, Airbus launched in 2019 an extended range version of the LR called the A321XLR (extra long-range), which is expected to enter service in 2023 (originally 2022). This aircraft can fly up to 4700 NM, 700 NM more than the LR, while utilizing the same technology – additional tanks and fuel, this time as rear center tanks (RCT). This reinstates the idea that Airbus found or guarantees a way of overcoming the payload limitations and is committing to long-range single-aisle aircraft.

Given the fact that the A321LR is a very recent aircraft there have not been in-depth studies so far, addressing the different aspects inherent to its operation. Furthermore, an investigation of such kind allows classifying this aircraft concerning its range capabilities, payload, costs, and emissions in order to find the best use cases. From the airline's perspective, this study can represent an important stepping stone prior to committing to this aircraft. For aviation enthusiasts, this work shall investigate the engineering potential of this aircraft.

## 1.2 Objectives

The main objective of this thesis is to assess operational aspects of the A321LR with a primary focus on the following:

- direct operating costs (DOC);
- fuel consumption;
- emissions (in the form of an Ecolabel rating);
- and cabin layout/capabilities.

The necessary theoretical foundation for understanding these four aspects shall be given, and appropriate assessing methods shall be used together with the essential aircraft data retrieved in the OEM's manual.

The investigation shall be performed taking into account actual use cases, i.e., routes employed by its operators, and lastly, comparing the results with similar aircraft, like its predecessors in the A320 family and the upcoming XLR.

The realization of the range improvements shall be investigated and substantiated regarding the ACTs and the additional fuel. It shall be understandable whether the ACT implementation is

sensible or not, with attention to the number of seats. These considerations shall take the other eventual limitations like sub-optimal fuel consumption into account. For this matter, the stated flight range by Airbus shall be thoroughly investigated, addressing all of the four main aspects pondered. These considerations should ultimately lead to a clear answer regarding the sustainability of operating the LR in short, medium, and long-haul flights.

Furthermore, the factors contributing to the cabin layout flexibility shall be exploited and contrasted with the cabin layouts employed by the aircraft operators while stating advantages and disadvantages in operating costs, fuel consumption, and emissions.

In the end, a benchmark for the LR shall be clearly visualized, and statements from the OEM in Chapter 1.1 regarding the performance of the aircraft found shall be discussed. This investigation should contribute to more accurate placement of the LR by its operators and potential future operators.

### 1.3 Literature

- Airbus (2020), “*A321 – Aircraft Characteristics Airport and Maintenance Planning*”, is the original manual from the OEM (Airbus) from which data regarding the A32LR, as well as the A321ceo and A321neo, has been retrieved. These data include the different aircraft weights, the payloads and ranges (combined in diagrams), the fuel capacities, the standard number of seats, cabin layouts, engine specifications, and information regarding the ACT. The corresponding data regarding the twin-aisle A330-900 neo was retrieved from Airbus (2021c), “*A330 – Aircraft Characteristics Airport and Maintenance Planning*”.
- Scholz (2011), lecture “*Flight Mechanics*” at the Department of Automotive and Aeronautical Engineering of the Hamburg University of Applied Science (HAW Hamburg), from which theoretical understanding regarding aircraft weights and fuel consumption was gained.
- Scholz (2015) lecture notes “*Aircraft Design*” available at the Hamburg Open Online University (HOOU), from which theoretical understanding regarding aircraft performance including operating costs and aircraft emissions was gained.
- Young (2017), “*Performance of the Jet Transport Airplane: Analysis Methods, Flight Operations, and Regulations*,” from which complementary information regarding the aircraft structural limitations regarding weight and fuel as well as aircraft emissions was retrieved.

- Scholz (2021a), “*Fuel Consumption Calculation Tool*” – this Excel tool was developed by Scholz and Burzlaff (2017) and received a significant update in 2021. It allows calculating the fuel mass at a given range by employing the Breguet Equation and successive iterations and visualizing the fuel consumption in graphs distributed over the flight range and number of seats. Publicly accessible.
- Scholz (2021b), “*PreSTo – Aircraft Preliminary Sizing Tool: DOC*,” is an extensive publicly accessible tool that aims to convert mission requirements into aircraft parameters. This tool covers multiple aspects of the preliminary aircraft sizing. In contrast, solely the sheet regarding the direct operating costs calculation with the use of the *AEA method* (first released 1989) was employed in this thesis.
- Scholz (2013), (presentation) “*DOC-Assessment Method: TU Berlin DOC Method*,” where another method of assessing the DOC – *the TU Berlin method* – is presented, which is more recent than the previous one and shall be employed for more accurate comparisons.
- Hurtecant (2021), “*Launch of an Ecolabel for Passenger Aircraft*” – the Ecolabel employed in the present thesis was launched in this work. There, relevant aspects regarding the ecological assessment of aircraft operation are appointed and explained. In the end, an Ecolabel is defined based on a weighing and rating system.

## 1.4 Structure of the Work

This work consists of seven main chapters. The structure of the thesis is as follows:

- |                  |  |
|------------------|--|
| <b>Chapter 2</b> | Theoretical aspects for a general understanding of this thesis are explained. The use cases for the A321LR are defined, and similar aircraft are appointed.  |
| <b>Chapter 3</b> | Here, the fuel consumption of the A321LR is assessed and showcased in graphs for better visualization of the results. The values are then compared to those of similar aircraft.   |
| <b>Chapter 4</b> | The direct operating costs of the A321LR are calculated using two different methods while considering the use cases defined. The results are displayed in tables and graphs. A comparison with similar aircraft is also given. |
| <b>Chapter 5</b> | An environmental assessment focusing on the emissions of the A321LR is performed using a recently launched tool.   |

- Chapter 6** The flexibility of the cabin layout of the A321LR is exploited and substantiated. An ergonomic study is performed.
- Chapter 7** Here, the findings originated in this thesis are discussed and finally compared to values from the industry and airlines.
- Chapter 8** A summary of the whole thesis and the knowledge retained is given.



## 2 Fundamentals

### 2.1 Aircraft Weights

Aircraft weights form a complex system that refers to the aircraft's different load stages. This chapter elucidates the terminology of the weights of an aircraft as well as their particularities.

The Manufacturer's Empty Weight (MEW) is the structural weight of an airplane, including the basic equipment, the engines, and all required systems.

The Operating Empty Weight (OEW), sometimes Operating Empty Mass, includes the MEW and the customer-specific permanently installed equipment such as passenger seats, galleys, or inflight entertainment equipment (IFE).

The Basic Weight (BW) consists of the OEW and all the fluids required to the aircraft's operation, including hydraulic fluids, oils, and the remaining fuel, which is unusable.

The Dry Operating Weight (DOW) contains the Basic Weight and the weight of the crew with its respective luggage and water and catering for the passengers.

The Zero Fuel Weight (ZFW) adds the weight of the aircraft's payload to the DOW, meaning the passengers and their respective luggage and cargo.

Take-off Weight (TOW) is defined as the Zero Fuel Weight plus the amount of usable fuel in the tanks at the moment of take-off.

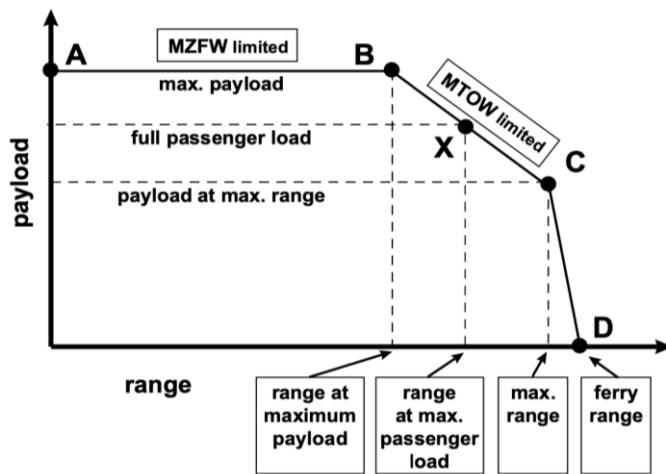
The Maximum Fuel Weight (MFW) describes the maximum possible fuel mass that the aircraft can carry. Generally, if the MFW is loaded, a payload reduction is necessary.

The maximum derivatives of the ZFW and the TOW are the Maximum Zero Fuel Weight (MZFW) and the Maximum Take-off Weight (MTOW). These are structural limiting loads that should not be exceeded by any means and are usually disclosed in the manufacturer's manual – typically in the *Aircraft Characteristics Airport and Maintenance Planning* (further ACAMP).

## 2.2 Payload-Range Diagram (PRD)

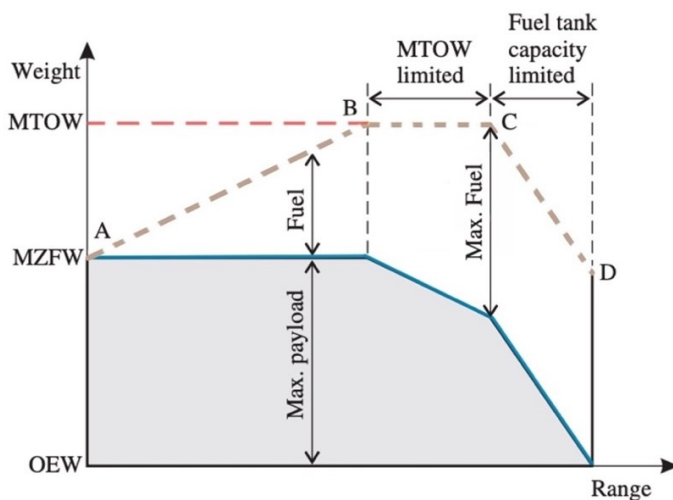
Payload-range diagrams are, as the name suggests, diagrams in which the payload (MTOW) and the range of an aircraft are related to each other. It is an essential asset for airlines and airport operators while planning missions, as it facilitates compliance with the structural limits of the aircraft. Payload-range diagrams are supplied in the manufacturer's ACAMP.

A generic payload-range diagram is presented in Figure 2.1. The different design points and ranges can be contemplated herein.



**Figure 2.1** Generic payload-range diagram (Scholz 2015)

Usually, the payload-range diagram is constructed over the OEW and combined with the limiting fuel weights to generate the extended payload-range diagram (EPRD), which can be used to describe every aircraft's performance – Figure 2.2.

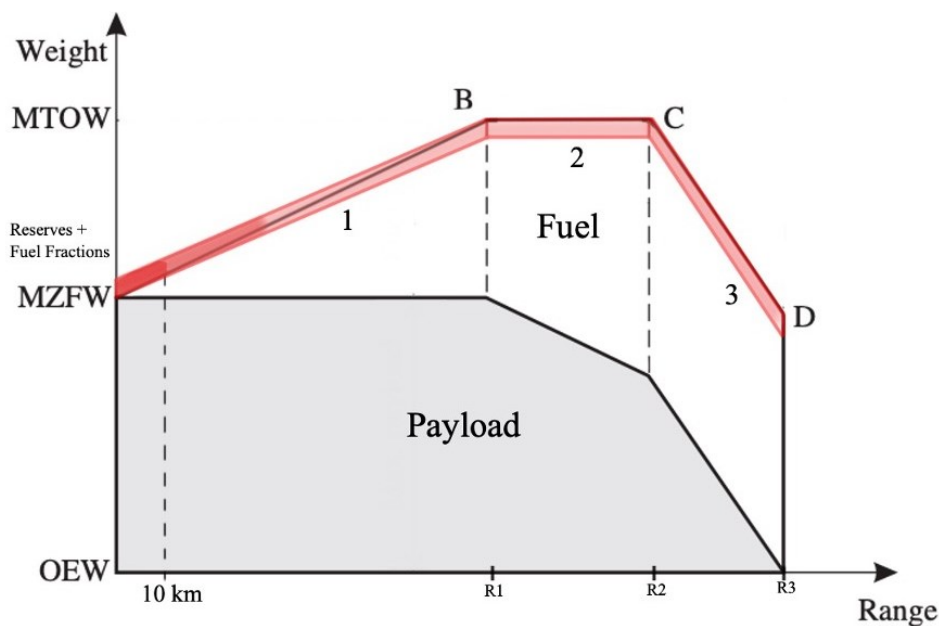


**Figure 2.2** Extended payload-range diagram, based on Young (2017, pp. 420)

The blue line describes the maximum possible payload mass depending on the distance of the planned route. The actual take-off weight of the aircraft is represented by the brown line, which reaches its peak at the level of the red line – the MTOW line. In the first section, it is possible to carry the maximum possible payload as the fuel demand increases with increasing range until **point B**.

In the second section, to fly further, it is necessary to carry more fuel, and in exchange, the payload has to be reduced. At the range of **point C**, also known as the design range, the aircraft's tanks are full and the payload reduced. Airlines normally operate aircraft until this design point as it still guarantees a good amount of payload.

Further beyond the design range, i.e., in the third section, the maximum permitted payload decreases drastically, and missions turn counterproductive from a strategic point of view, as the tanks are already full. The ferry range is reached at **point D**, where no more payload can be carried, and the fuel tanks are emptied.



**Figure 2.3** Payload-range diagram accounting the fuel reserves and the fuel fractions; based on Young (2017, pp. 420)

Furthermore, it is worth noting that this sort of extended payload-range diagram, even though widely employed, contains some assumptions for the sake of simplicity:

1. On every aircraft's fuel tank, a certain amount of fuel remains unused because it is impossible to inject it into the turbines for physical reasons. This fuel is generally included in the OEW, causing it to rise. Figure 2.3 shall elucidate this observation, where the unusable fuel is virtually added on top of the MZFW. On the other hand, as the MTOW can't be exceeded, this converts into a compulsory maximum payload reduction.

2. For every aircraft trip, independent of the distance, reserves must be taken on board (see Section 2.4.2.4). These reserves are also neglected on a general EPRD.
3. For very short trips, the amount of fuel spent on take-off, climb, descent, and landing is proportionally very high compared to the cruise flight – Fuel Fractions, see Section 2.3.1.2. A fair example is a trip with a range of 10 km, in which the fuel consumed during the non-horizontal flight takes very high proportions.

All the above-described factors cause a variation of the slope within sections 1 and 3 to a lower extent. Furthermore, the slope is not perfectly linear, as, in reality, it is more of a curvature.

## 2.3 Approach to the Fuel Consumption

The presented estimation of the **consumed fuel during a flight** is based on the Breguet Range Equation, derivated from the French aviation pioneer Louis Breguet (1880-1995). This equation is based on the rate of an aircraft's mass change during its flight, which per se already implies the fuel consumption, considering that this is theoretically the only relevant mass change during a typical commercial flight.

### 2.3.1 Breguet Range Equation

The derivation of the equation is therefore demonstrated here (Scholz 2011).

The fuel mass flow  $Q$  is defined as the change of fuel mass  $m_f$  per time  $t$ .

$$Q = -\frac{m_{f2}-m_{f1}}{t_2-t_1} = -\frac{\Delta m_f}{\Delta t} = -\frac{\Delta m}{\Delta t} = -\frac{dm}{dt} \quad (2.1)$$

The fuel mass flow  $Q$  for a specific aircraft depends on its type of propulsion. For engine powered aircraft, the fuel mass flow  $Q_{Jet}$  is defined as

$$Q_{Jet} = c \frac{D}{L} \cdot w = \frac{c}{E} \cdot m \cdot g \quad (2.2)$$

$c$  is the thrust-specific fuel consumption (*TSFC*).  $D$  is the aircraft's drag coefficient, whereas  $L$  is the lift coefficient.  $E$  is the glide ratio of the considered aircraft.

To account for a distance in dependency of velocity  $V$  and time  $t$ , (Eqn.) 2.3 is generally used.

$$R = V \cdot t \quad (2.3)$$

Following Eqn. (2.1) and (2.3), the change of range  $dR$  is

$$dR = V \cdot dt = -\frac{V}{Q} dm \quad (2.4)$$

The range  $R$  is calculated through the integration of Eqn. (2.4).

$$R = -\int \frac{V}{Q} dm \quad (2.5)$$

For simplification, the following calculation is based on the range equation of an engine-powered aircraft ( $Q = Q_{Jet}$ ). Eqn. (2.2) is inserted into Eqn. (2.5).

$$R = -\int \frac{V \cdot E}{c \cdot g} \cdot \frac{1}{m} dm \quad (2.6)$$

By integrating this term, the Breguet Equation is ascertained

$$R = -\frac{V \cdot E}{c \cdot g} \int_{m_1}^{m_2} \frac{1}{m} dm = \frac{V \cdot E}{c \cdot g} [\ln(m)]_{m_1}^{m_2} \quad (2.7)$$

and results in

$$R = \frac{V \cdot E}{c \cdot g} \ln \frac{m_1}{m_2} \quad (2.8)$$

This is the Breguet Range Equation, which can be used to calculate the change of aircraft mass during a flight by given flown distance.

**Note:** Not all aircraft data present in this equation is disclosed for public access by the manufacturer. Therefore, in most cases, the Breguet range equation cannot be used in this form. Some examples of this data are the specific fuel consumption and the glide ratio, generally kept in secrecy.

Therefore, a different procedure must be chosen. The fuel mass calculation can, for example, be based on the already introduced payload-range diagram.

### 2.3.1.1 Breguet Factor for Horizontal Flight

In the project of Burzlaff (2017), a procedure is demonstrated for using the Breguet range equation solely based on publicly accessible data. To achieve this, the Breguet Factor must be defined.

Based on Eqn. (2.8), the Breguet Factor is written as

$$B = \frac{V \cdot E}{c \cdot g} . \quad (2.9)$$

This forms the Breguet range equation to

$$R = B \cdot \ln \frac{m_1}{m_2} . \quad (2.10)$$

A reposition of Eqn. (2.10) leads to

$$B = \frac{R}{\ln \frac{m_1}{m_2}} . \quad (2.11)$$

For this calculation of the Breguet Factor, every data can be obtained from the payload-range diagram.

**Note:** this way of calculation is only valid for the horizontal flight.

### 2.3.1.2 Fuel Fractions

To adapt the Breguet Factor calculation not only to the horizontal flight (cruise) but to the whole flight, including take-off, climb, cruise, descend, loiter (hold), and landing, Fuel Fractions are applied.

A fuel fraction is a relation between the mass  $m_2$  at the end of a flight phase and the mass  $m_1$  at the beginning.

$$M_{ff} = \frac{m_1}{m_2} \quad (2.12)$$

The Fuel Fraction  $M_{ff}$  for an entire flight includes

$$M_{ff} = \frac{m_{Shut\ Off}}{m_{Landing}} \cdot \frac{m_{Landing}}{m_{loiter}} \cdot \frac{m_{loiter}}{m_{Descend}} \cdot \frac{m_{Descend}}{m_{Reserve}} \cdot \frac{m_{Reserve}}{m_{Climb}} \cdot \frac{m_{Climb}}{m_{Descend}} \cdot \frac{m_{Descend}}{m_{Cruise}} \cdot \frac{m_{Cruise}}{m_{Climb}} \cdot \frac{m_{Climb}}{m_{Take\ Off}} \quad (2.13)$$

which can be written as

$$M_{ff} = M_{ff,Ldg} \cdot M_{ff,Loi} \cdot M_{ff,Des} \cdot M_{ff,Res} \cdot M_{ff,Clb} \cdot M_{ff,Des} \cdot M_{ff,Cr} \cdot M_{ff,Clb} \cdot M_{ff,To} \quad (2.14)$$

These fuel fractions are separated into two groups in terms of flight phases, as shown in Table 2.1.

**Table 2.1** Fuel fraction on horizontal and non-horizontal flight phases

Flight phase	Horizontal flight	Non-horizontal flight
Fuel Fraction	$M_{ff,Cr}, M_{ff,Res}, M_{ff,Loi}$	$M_{ff,To}, M_{ff,Clb}, M_{ff,Des}, M_{ff,Ldg}$

After Table 2.1, the fuel fraction for an entire flight can be written as

$$M_{ff} = M_{ff,Cr-Res-Loi} \cdot M_{ff,LTO} \quad (2.15)$$

$M_{ff,LTO}$  conflates all fuel fractions for non-horizontal flight phases.

Based on calculations with the Optimization in Preliminary Aircraft Design Software (OPERA), a value of

$$M_{ff,LTO} = 0,994^6 = 0,95929 \quad (2.16)$$

has been detected as most precise (MacDonald 2012). This value should be further used to adjust the Breguet Factor to cover the entire flight within the calculation.

### 2.3.1.3 Breguet Factor for Entire Flight

The Breguet Factor in Eqn. (2.11) is limited to the horizontal flight. Since the calculation described in this chapter should cover the entire flight, including non-horizontal flight phases, the fuel fraction was introduced in Section 2.3.1.2.

A fuel fraction for an entire flight can be written after reordering Eqn. (2.12) as

$$\frac{m_1}{m_2} = \frac{1}{M_{ff}} \quad (2.17)$$

With the inclusion of Eqn. (2.15), the entire flight is depicted with

$$\frac{m_1}{m_2} = \frac{1}{M_{ff,Cr-Res-Loi} \cdot M_{ff,LTO}} \quad (2.18)$$

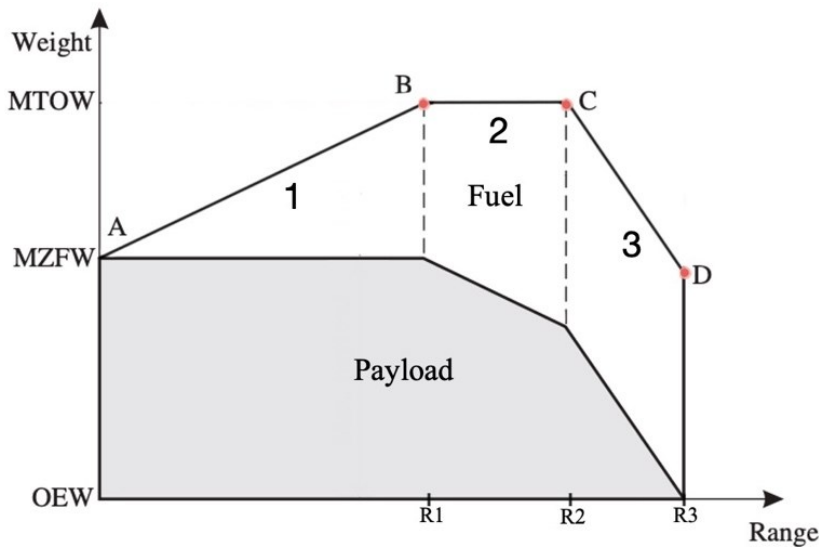
To cover the entire flight, the mass ratio is adjusted to rely on the horizontal flight mass ratio.

$$M_{ff,LTO} \cdot \frac{m_1}{m_2} = \frac{1}{M_{ff,Cr-Res-Loi}} \quad (2.19)$$

Following, Eqn. (2.19) is appointed to Eqn. (2.11).

$$B = \frac{R}{\ln \left( M_{ff,LTO} \cdot \frac{m_1}{m_2} \right)} \quad (2.20)$$

Moreover, with the knowledge about the payload-range diagram so far, the Breguet Factor for strategic points can be calculated with the help of Eqn. 2.20. These points are marked in Figure 2.4 as they are relevant for further calculation of the fuel mass.



**Figure 2.4** Payload-range diagram with strategic points for the Breguet Factor calculation; based on Young (2017, pp. 420)

These points coincide with already discussed aircraft weights like the MTOW, the MZFW, and the OEW. Furthermore, the ranges at which these weights apply (points B, C, and D) are to be determined. As seen in Chapter 2.2, the referred information can be retrieved from the payload-



range diagrams present in the ACAMP. An overview of the points is presented in Table 2.2. Following, this information is employed in the Breguet Range Equation (MacDonald 2012).

**Table 2.2** Range, take-off, and landing weights for strategic points in the payload-range

Point	Range	Take-off weight	Landing weight
A	R1 (range max. payload)	MTOW	MZFW
B	R2 (design range)	MTOW	MTOW-MFW
C	R3 (ferry range)	OEW+MFW	OEW

The Breguet Factors for these three points provide the mathematical foundation for the fuel estimation. The structure of each point's Breguet Factor calculation is based on Eqn. (2.20), which together with Table 2.2, results in

Point B:

$$B_B = \frac{R}{\ln\left(M_{ff,LTO} \frac{MTOW}{MZFW}\right)}, \quad (2.21)$$

Point C:

$$B_C = \frac{R}{\ln\left(M_{ff,LTO} \frac{MTOW}{MTOW - MFW}\right)}, \quad (2.22)$$

and Point D:

$$B_D = \frac{R}{\ln\left(M_{ff,LTO} \frac{OEW - MFW}{OEW}\right)}. \quad (2.23)$$

To determine the Breguet Factor in points in-between the discussed topics, an interpolation can be performed. This is the case, for example, in sections 2 and 3 of the diagram, where a decrease in the payload is observed. The interpolation can be done with the help of Isaac Newton's linear interpolation.

$$f(x) = f_0 + \frac{f_1 - f_2}{x_1 - x_2} (x - x_0) \quad (2.24)$$

In this specific case, the Eqn. (2.24) can be transformed as shown in Eqns. (2.25) and (2.26).

Interpolation within section 2.

$$B(R) = B_B + \frac{B_C - B_B}{R_2 - R_1} (R - R_1) \quad (2.25)$$

Interpolation within section 3.

$$B(R) = B_C + \frac{B_D - B_C}{R_3 - R_2} (R - R_2) \quad (2.26)$$

### 2.3.2 Fuel Mass Calculation

Based on Breguet, the range can be estimated with the previous Eqn. (2.10)

$$R = B \cdot \ln \frac{m_1}{m_2} , \quad (2.10)$$

where  $m_1$  is the mass before take-off and  $m_2$  is the aircraft mass after landing. The difference between  $m_1$  and  $m_2$  can be assumed as the burned fuel mass  $m_{fuel}$ . Therefore, (Eqn. 2.27) applies (Wulbrand 2016).

$$m_{fuel} = m_2 - m_1 \quad (2.27)$$

With Eqn. (2.27), Eqn. (2.10) can be rewritten as

$$R = B \cdot \ln \left( \frac{m_1 + m_{fuel}}{m_2} \right) . \quad (2.28)$$

To calculate the estimated fuel mass  $m_{fuel}$ , the rearrangement results in

$$m_{fuel} = m_2 \left( e^{\frac{R}{B}} - 1 \right) . \quad (2.29)$$

This is the **final equation** to calculate the estimated fuel mass  $m_{fuel}$ , depending on the range  $R$  and the Breguet Factor  $B$ .

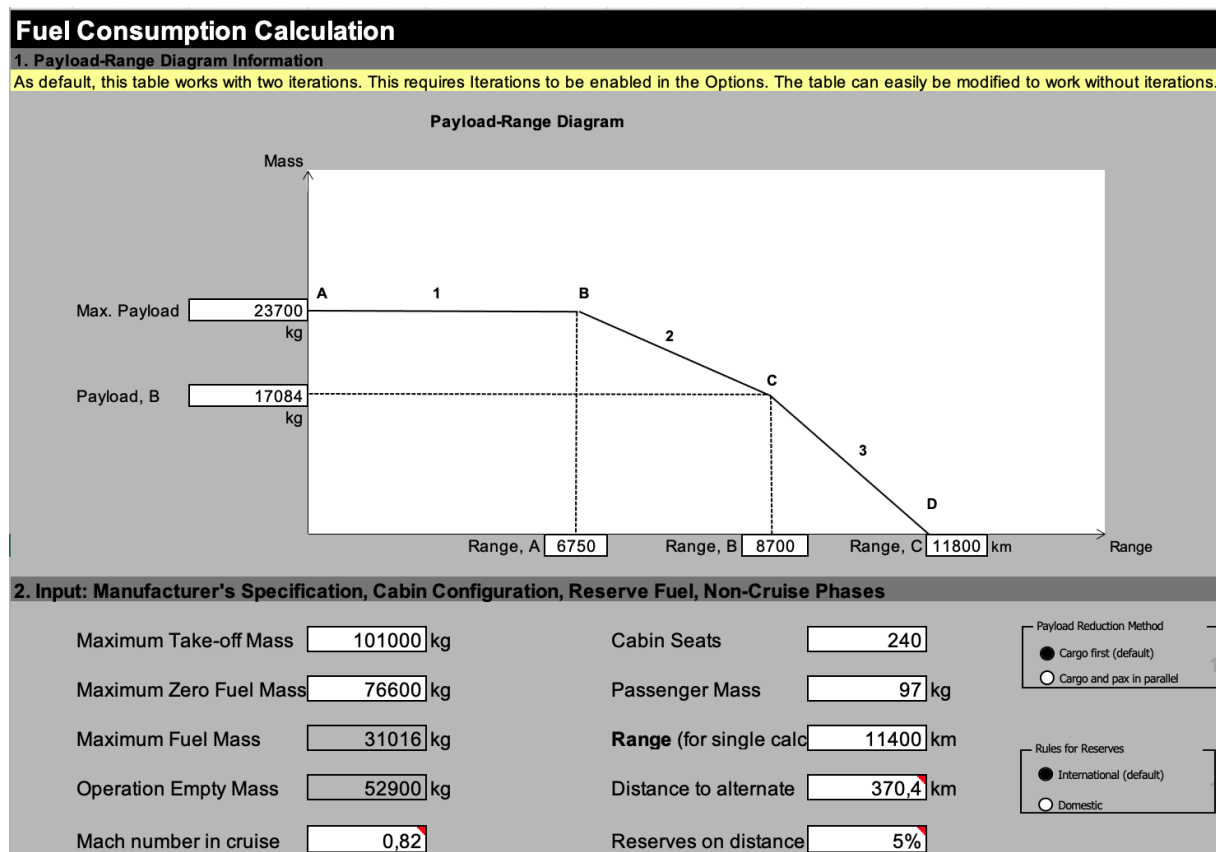
To highlight the dependency on the range, this (Eqn.) 2.30 may be used.

$$m_{fuel}(R) = m_2 \left( e^{\frac{R}{B}} - 1 \right) \quad (2.30)$$

### 2.3.3 Implementation of an Excel Tool

The method discussed so far has been programmed in an Excel tool in the *Aircraft Fuel Consumption – Estimation and Visualization* project by Burzlaff (2017) and received a major update by Scholz (2021a).

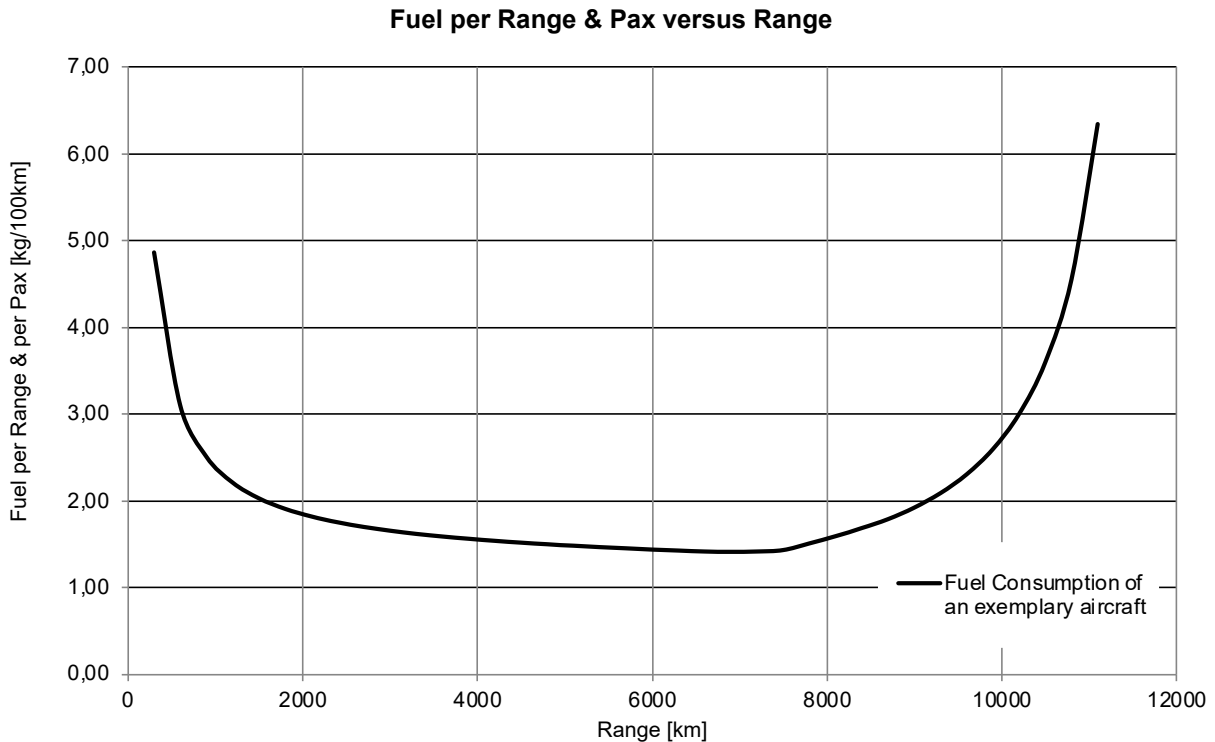
After inputting the required aircraft data and flight range, the program calculates consumed fuel mass and offers different visualizations on the fuel consumption. This program was employed for the fuel calculation and visualization present in this thesis. Figure 2.5 shows the user interface of the file. More detailed views can be retrieved in Appendix A.



**Figure 2.5** User interface of the fuel calculation tool (Burzlaff 2017; Scholz 2021a)

## 2.3.4 Visualization of the Fuel Consumption

### 2.3.4.1 Bathtub Curve – Fuel per Range and Pax over Range

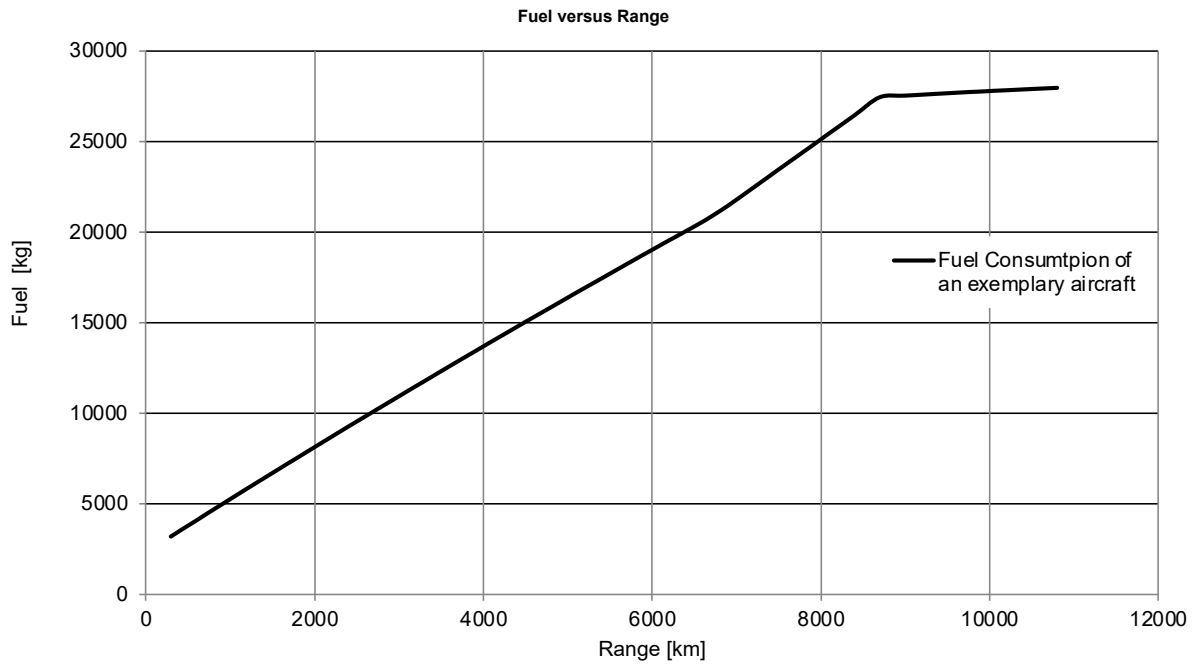


**Figure 2.6** Fuel consumption: fuel per range over range visualization (generated with Scholz 2021a)

Figure 2.6 shows the visualization of the fuel consumed per (100) km and passenger over the flight range. The result is a typical “bathtub curve,” meaning that the curve has a convex character. At shorter ranges, the fuel consumption per passenger and range is comparatively high since the effect of the fuel reserves predominates, and the required trip fuel correlates to them (the reserves). With increasing range, this effect fades away, and thus the fuel consumption decreases to a minimum. After this point, the effect of “*fuel per fuel*” is predominant (MTOW limited). From the point of the payload reduction (point B, see Chapter 2.2), higher fuel consumption is registered, as the fuel is distributed over fewer and fewer passengers. This trend maintains until infinity, meaning that no passenger can be carried anymore (ferry range).

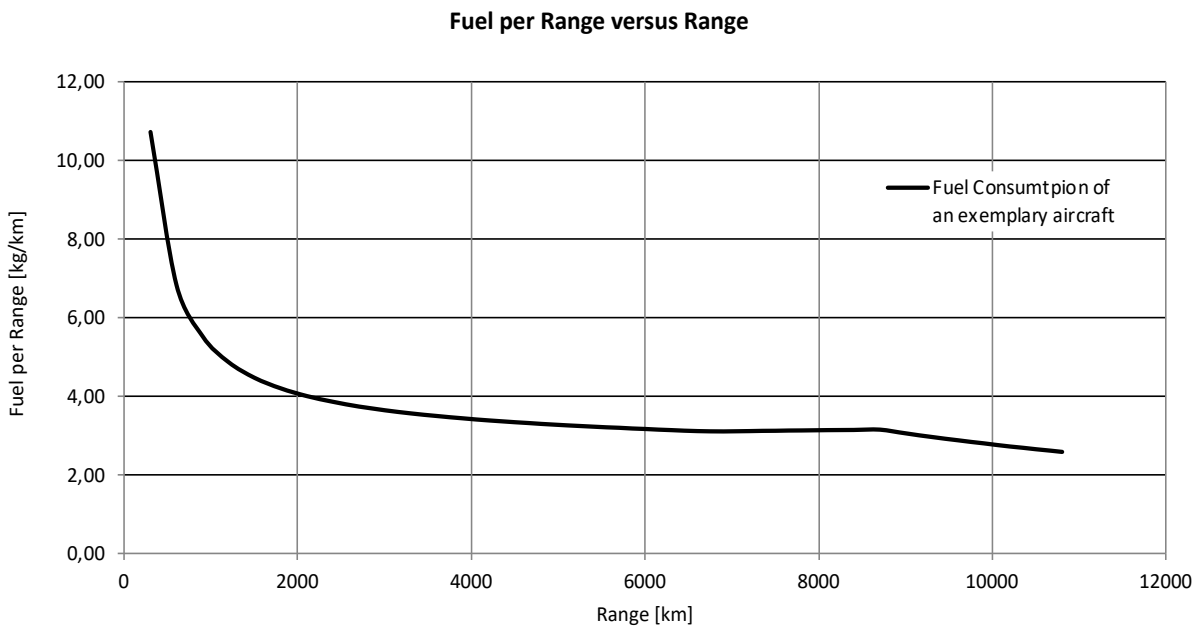
### 2.3.4.2 Fuel over Range Chart

Figure 2.7 shows the visualization of the total fuel consumed over the flight range (km). As expected, the resulting curve contains a steadily increasing slope, which shows a slight deflection at the range of the aircraft’s point B (range at MPL). From a certain point onwards (C), the fuel consumption maintains a constant level until the ferry range is reached.



**Figure 2.7** Fuel consumption: fuel per range over range visualization (generated with Scholz 2021a)

### 2.3.4.3 Fuel per Range over Range Chart



**Figure 2.8** Fuel consumption: fuel over range visualization (generated with Scholz 2021a)

Figure 2.8 shows the visualization of the fuel consumed per km over the flight range. The resulting curve shows a decreasing convex slope until the ferry range. Similar to the bathtub curve, the fuel consumption is very high at shorter ranges and decreases with increasing range.

The curve ends at the point of ferry range. In this example, it can be stated that in terms of fuel consumption (efficiency), the most indicated missions are allocated between 6.000 and 7.500 km.

## 2.4 Approach to the Direct Operating Costs

A vital aspect of every industrial activity or service is assessing its performance, which should be in the interest of each stakeholder. This is also true for the civil aviation industry, given the fact that aircraft represent significant investments. Thus, a profitable market strategy shall have high priority. This applies to the OEM, to the operators, and lastly, to the passengers, which are the ones to be transported.

Amongst others, the assessment can be done regarding various scopes, e.g., financial aspects, environmental impact, life cycle analysis, and the perceived added value of the activity itself. The methods present in this chapter explore the operating costs of the A321LR, implying that this is from financial character and is focusing on the operator(s), which are lastly the airlines. Figure 2.9 offers an overview of some of the financial assessment methods regarding the aircraft industry and its stakeholders (OEM and operators).

With selective additions, the information present in this chapter is extracted from the lecture notes regarding DOC calculation from the lecture “*Aircraft Design*” by Scholz (2015), if not indicated differently.

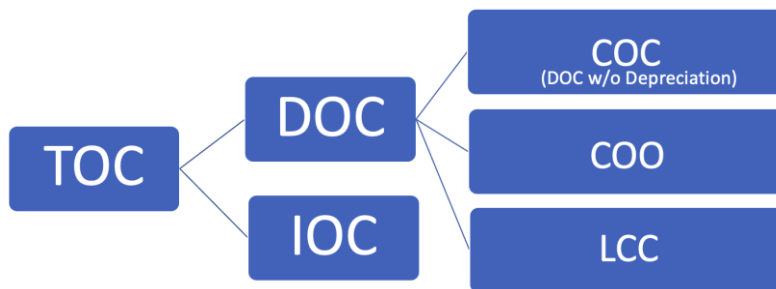
Return on investment – Net present value – Break-even point			
Manufacturer's perspective		Operator's perspective	
Revenues	Expenses	Revenues	Expenses
<ul style="list-style-type: none"> <li>• estimated aircraft price</li> <li>• estimated sales figures (See also Chapter 3)</li> </ul>	Cost methods according to <ul style="list-style-type: none"> <li>• Nicolai 1975</li> <li>• Roskam VIII 1990</li> <li>• Raymer 1992</li> </ul>	<ul style="list-style-type: none"> <li>• estimated ticket price</li> <li>• estimated load factor (See also Chapter 3)</li> </ul>	Cost methods according to <ul style="list-style-type: none"> <li>• LCC</li> <li>• GOC</li> <li>• IOC</li> <li>• TOC</li> <li>• <b>DOC:</b> <ul style="list-style-type: none"> <li>• ATA 1967</li> <li>• AA 1980</li> <li>• DLH 1982</li> <li>• <b>AEA 1989</b></li> <li>• AI 1989</li> <li>• Fokker 1993</li> </ul> </li> </ul>

**Figure 2.9** Overview of different cost methods: calculation methods for the DOC (Scholz 2015) – see Appendix B

As shown in Figure 2.9, many different cost methods can be used by airlines. These methods abet estimating the net profit since they represent expenses and can be therefore contrasted with the revenue channels. Some examples are the LCC (Life-Cycle Costs), the COC (Cash Operating Costs), the IOC (Indirect Operating Costs), the DOC (Direct Operating Costs), the COO (Cost of Ownership), and the TOC (Total Operating Costs).

In this thesis, the focus will be on the direct operating costs calculation, given the fact that these methods englobe all the operational costs and are thus widely accepted and employed by airliners. The pioneer DOC method was the ATA 1967 (Air Transport Association in 1967).

All the DOC methods share the commonality of containing only the *aircraft-related costs*, disregarding costs indirectly associated with their operation (IOC) – this is mostly the purpose. The diagram in Figure 2.10 elucidates the relationship between the different cost assessment methods.



**Figure 2.10** Relationship between cost assessment methods

DOC methods generally evaluate costs regarding:

- depreciation  $C_{DEP}$ ;
- interest  $C_{INT}$ ;
- insurance  $C_{INS}$ ;
- fuel  $C_F$ ;
- maintenance  $C_M$ ;
- crew  $C_C$ ;
- fees and charges  $C_{FEE}$ .

What mainly distinguishes the methods from each other are the values assumed in the referred individual cost elements. A generic equation to calculate the direct operating costs from the aircraft costs  $C$  can therefore be obtained with

$$C_{DOC} = C_{DEP} + C_{INT} + C_{INS} + C_F + C_M + C_C + C_{FEE} . \quad (2.31)$$

Amidst these options, the **AEA 1989** method was chosen for the DOCs assessment due to its complexity (it considers all of the previously referred cost shares) and its popularity.

Furthermore, another DOC method, the TU Berlin method, will also be applied to contrast the results and make comparisons. The TUB method is more recent, and as the name suggests, it was developed by the Technical University of Berlin, more concretely by its Aerospace Engineering Faculty. This method has the advantage of being more contemporaneous and thus reflecting more recent (realistic) values. Some values have been updated by Scholz (2013) and will be employed hereon.

### 2.4.1 Representation of the DOC

After an adequate method was found, the next choice regards the representation of the DOCs, meaning how they are to be expressed. The stakeholder makes this choice in such a way that it fits its interest. The rule of thumb is to employ a representation in the most understandable way(s) possible to compare and make decisions according to the obtained results.

A widespread representation is the costs incurred by an aircraft (index:  $a/c$ ) in a fleet within one calendar year (index:  $a$ ). In this case,  $C_{DOC} = C_{a/c, a}$ . This implies that the individual cost shares are also calculated for one year.

In the same logic, the DOCs can also be calculated for a specific range  $R$ , a particular flight time  $t_f$  or block time  $t_b$ , or for a particular trip (index:  $t$ ) in case the total number of flight-cycles per year is known  $n_{t, a}$  (explained in 2.4.2.8).

$$C_{a/c, t} = \frac{C_{a/c, a}}{n_{t, a}} \quad (2.32)$$

By relating the DOCs with the distance flown, one obtains (depending on the unit used) the aircraft-mile costs or aircraft-kilometer costs.

$$C_{a/c, m} = \frac{C_{a/c, t}}{R} = \frac{C_{a/c, a}}{n_{t, a} R} \quad (2.33)$$

If the DOCs are correlated with the distance flown and the number of seats (or the maximum number of passengers) for a given flight, the aircraft **seat-mile costs** (SMC) or aircraft **seat-kilometer costs** (SKC) are obtained.



$$C_{s,m} = \frac{C_{a/c,t}}{n_{pax} R} = \frac{C_{a/c,a}}{n_s n_{t,a} R} \quad (2.34)$$

In the ACAMP, the manufacturer indicates a specific number of seats according to a standard two (usual) or three-class layout. The adequate number of seats is ultimately the operators' choice according to their needs, which means that cabin layouts are likely to be arranged differently by different airlines and also for short-, medium-, and long-haul flights. The calculation of seat-mile costs is then still purely a cost analysis. However, the revenue potential is already included to a certain extent in this representation because an alternative aircraft or cabin layout with more seats reduces the seat-mile costs while the aircraft trip costs remain the same.

The revenue potential can also be assessed by relating the DOCs to the distance flown and the payload. If only the payload of passengers and luggage is considered, the *aircraft seat-ton-mile costs* (depending on the unit used) are obtained.

$$C_{pax,t,m} = \frac{C_{a/c,t}}{(m_{pax} + m_{baggage})R} = \frac{C_{a/c,a}}{(m_{pax} + m_{baggage}) n_{t,a} R} \quad (2.35)$$

If the total payload, including cargo is considered, then the aircraft ton-mile costs (depending on the unit used) can be written as.

$$C_{t,m} = \frac{C_{a/c,t}}{m_{PL}R} = \frac{C_{a/c,a}}{m_{PL} n_{t,a} R} \quad (2.36)$$

The direct operating costs can also be related to the flight time,  $t_f$  or block time,  $t_b$ . The term *flight time* is defined in CS-1 and stated by Scholz (2015):

*"Flight time" means the time between lift-off and touchdown.*

Whereas the term *block time* is according to WATOG (1992):

*"Time that commences when an aircraft moves under its own power for the purpose of flight and ends when the aircraft comes to rest after landing."*

As opposed to the flight time, the block time also includes ground times, such as due to the push back of the aircraft, taxi before take-off and after landing, or waiting on the ground for clearance. Table 2.3 contains assumed time differences  $\Delta t = t_b - t_f$  in the AEA method for short- and medium-haul (a) and for long-haul flights (b).

**Table 2.3** Standardized assumed time difference between block time and flight time

$\Delta t = t_b - t_f$	remark	source
15 min. = 0.25 h	short and medium range	<b>AEA 1989a</b>
25 min. = 0.42 h	long range	<b>AEA 1989b</b>

## 2.4.2 Calculation of the DOCs with the AEA Method

Following, the calculation of the single cost elements for the AEA method is explained.

### 2.4.2.1 Depreciation

Depreciation  $C_{DEP}$  is perceived as the reduction in the value of an item over its useful service life  $n_{DEP}$ . The useful service life  $n_{DEP}$  is characteristic for each item, and with it, the occurring decrease in value per year can be determined. Therefore, the total purchase price  $P_{total}$  of an item sets the highest (initial) value of the new item.

Especially in the aircraft industry, airlines tend to keep new aircraft for a certain period and then sell them to other (minor) ones at the end of their considered service life. Nevertheless, these aircraft are still airworthy. The selling price corresponds to the residual value  $P_{residual}$  of the aircraft.

The reduction in value is therefore obtained with  $P_{total} - P_{residual}$  and the depreciation

$$C_{DEP} = \frac{P_{total} - P_{residual}}{n_{DEP}} = \frac{P_{total} \left(1 - \frac{P_{residual}}{P_{total}}\right)}{n_{DEP}} . \quad (2.37)$$

The AEA method considers two different  $n_{DEP}$  depending on the aircraft type: short and medium-range; or long-range. These values correspond to the AEA 1989a and AEA 1989b, respectively. The relative residual value  $P_{residual}/P_{total}$  is identical in both cases. – see Table 2.4. Furthermore, the total purchase price of an aircraft  $P_{total}$  not only comprises the delivery price  $P_{delivery}$  but also the price for the spare parts  $P_S$  purchased with each aircraft.

$$P_{total} = P_{delivery} + P_S \quad (2.38)$$

The delivery price  $P_{delivery}$  includes:

the *list price* for a standard configuration (manufacturers standard price):

- from which discounts are deducted;
- to which surcharges for modifications (change orders) are added;
- the price for equipment components that the customer buys on their own (buyer furnished equipment, BFE). This may also include engines, which account for a considerable proportion of the total price of the aircraft;
- the interest on construction progress payments.

In a comparative study of different aircraft, estimations for  $P_{delivery}$  methods can safely be employed as the relative value to each other stays coherent. **Note:** In case of having access to actual market prices, i.e., from airlines' or OEM's official statements, these values should be prioritized if the aim is to be the most realistic as possible.

Assuming that  $n_E$  is the number of engines, the price for the spares  $P_s$  is calculated from a proportion  $k_{S,AF}$  of the cost of the airframe  $P_{AF}$  and a proportion  $k_{S,E}$  of the price of the engines  $n_E P_E$ . Table 2.4 contains the proportions  $k_{S,AF}$  and  $k_{S,E}$ .

$$P_S = k_{S,AF} P_{AF} + k_{S,E} n_E P_E \quad (2.39)$$

The price of the airframe is the price of the aircraft minus the price of the engines.

$$P_{AF} = P_{delivery} - n_E P_E \quad (2.40)$$

The engine price can be obtained from the manufacturer or be estimated according to the Eqn.(2.41). The estimate is based on the take-off thrust  $T_{T/O,E}$  of one engine in  $N$ .

$$P_E = 293 \text{ US\$} \cdot \left( \frac{T_{T/O,E}}{N} \right)^{0,81} \quad (2.41)$$

**Table 2.4** Parameters for the calculation of depreciation

Source	$n_{DEP}$	$\frac{P_{residual}}{P_{total}}$	$k_{S,AF}$	$k_{S,E}$
AEA 1989a	14	0.10	0.10	0.30
AEA 1989b	16	0.10	0.10	0.30

### 2.4.2.2 Interest

It is assumed that the investment for a new aircraft (price:  $P_{total}$ ) is financed solely from outside sources. Therefore  $k_0 = P_{total}$ . The interest payable to the investor  $C_{INT}$  is calculated with the aid of an average interest rate  $p_{av}$  and comes to the following per year

$$C_{INT} = p_{av}k_0 = p_{av}P_{total} \quad . \quad (2.42)$$

The average interest rate is inserted in the DOC methods as an operand for the sake of simplicity and is included in Table 2.5.  $p_{av}$  is lower than the interest rate  $p$  that one would expect on the capital market.

A more detailed version assumes that the outside capital will be repaid in equal installments and annual payments  $a$  at the end of the year over  $n_{PAY}$  years. After the  $n_{PAY}$  years, a relative residual value  $k_n/k_0$  of the outside capital may then remain in the company. This relative residual value of the external capital is independent of the relative residual value of the depreciation  $P_{residual}/P_{total}$  and may differ from this.

To calculate the average interest, the Eqn. (2.43) can be taken from any math book on financial mathematics.

$$a = \frac{k_0 \left( q^n - \frac{k_n}{k_0} \right) (q - 1)}{q^n - 1} = \frac{k_0 \left( q^{n_{PAY}} - \frac{k_n}{k_0} \right) (q - 1)}{q^{n_{PAY}} - 1} \quad (2.43)$$

Here,  $n$  is the number of repayment years, designated  $n_{PAY}$  to avoid mistaking it with the useful service life  $n_{DEP}$ , whereas  $a$  refers to the size of the required annual installment.

Eqn. (2.44) shows the overall expenses in interest and amortization as a total payment over a period of  $n_{PAY}$  years. The total redemption payment is, by definition,  $k_0 - k_n$ . The total interest payments are then the difference between the total payment and the redemption payments.

$$a n_{PAY} - (k_0 - k_n) = a n_{PAY} - k_0 \left( 1 - \frac{k_n}{k_0} \right) \quad (2.44)$$

To calculate an average interest rate, these interest payments are spread over  $n_{DEP}$  years, during which the aircraft is depreciated. Per year this comes to an interest of

$$C_{INT} = \frac{a n_{PAY} - k_0 \left( 1 - \frac{k_n}{k_0} \right)}{n_{DEP}} \quad . \quad (2.45)$$

According to the definition of the average interest rate, this is also

$$C_{INT} = p_{av} k_0 \quad . \quad (2.46)$$

Eqn. (2.45) together with Eqn. (2.46) gives

$$p_{av} = \frac{a n_{PAY} - k_0 \left(1 - \frac{k_n}{k_0}\right)}{n_{DEP} k_0} , \quad (2.47)$$

and finally, Eqn. (2.47) together with Eqn. (2.43) provides the calculation equation for the **average interest rate**.

$$p_{av} = \frac{\left(q^{n_{PAY}} - \frac{k_n}{k_0}\right) (q - 1) n_{PAY}}{q^{n_{PAY}} - 1} - \left(1 - \frac{k_n}{k_0}\right) \quad (2.48)$$

The average interest rate  $p_{av}$  assumed by the AEA method and the parameters of Eqn. (2.48) according to which  $p_{av}$  is calculated, are shown in Table 2.5.

**Table 2.5** Parameters for the calculation of the average interest rate  $p_{av}$

Source	$p$	$q = 1 + p$	$n_{PAY}$	$\frac{k_n}{k_0}$	$n_{DEP}$	$p_{av}$
AEA 1989a	0.08	1.08	14.0	0.1	14.0	0.0529
AEA 1989b	0.08	1.08	16.0	0.1	16.0	0.0529

### 2.4.2.3 Insurance

The AEA method considers the costs caused by insuring the aircraft hull against damage or even against hull loss. The insurance costs incurred per year  $C_{INS}$  are calculated as a percentage of the aircraft price for the sake of simplicity.

$$C_{INS} = k_{INS} P_{delivery} \quad (2.49)$$

The  $k_{INS}$  considered by the AEA methods is 0,005.

### 2.4.2.4 Fuel Costs

The fuel costs incurred per year  $C_F$  are calculated according to

$$C_F = n_{t,a} P_F m_F . \quad (2.50)$$

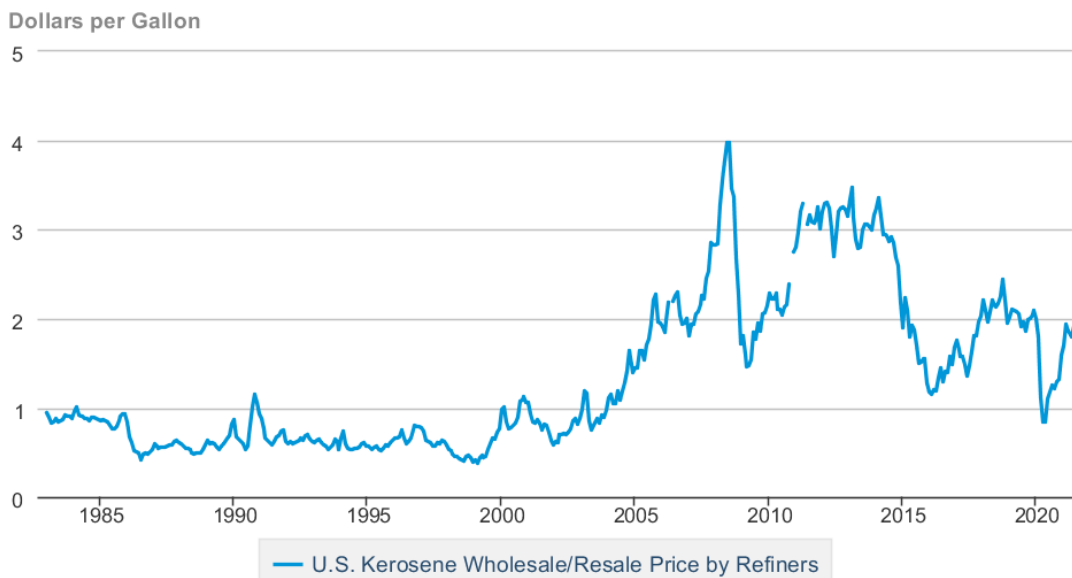
In this equation,  $P_F$  is the fuel price (concerning a mass unit), and  $m_F$  is the mass of the fuel consumed during a flight.

The number of flights per year  $n_{t,a}$  is dealt with in more detail in Section 2.4.2.8. For the moment, it is assumed this value can be extracted from the airline's statistics.

The fuel price for aircraft consists not only of the kerosene price per mass unit but also of the fees that accrue due to its transportation until the aircraft ("Into Plane Differential"). Generally, the kerosene price is subject to considerable fluctuations and, in extreme cases, inflations. For this matter, the fuel price must be researched carefully, as it stands as the central point for the fuel costs and keeps a realistic ratio towards the various operating costs. At the time of publication of this thesis,  $P_F = 0.40 \text{ US\$/kg}$  is a plausible value and is therefore employed for the fuel costs calculation (IATA 2021).

In the case of a design assessment, not only the current fuel price is of interest, but rather the fuel price on the date in the future when the projected aircraft is to be operated. Despite not being known, this fuel price can be estimated. In these cases, it is indeed helpful to evaluate the price trend in the past to determine a range within the parameter  $P_F$  can be varied. Figure 2.11 shows the fuel price development since 1980.

### U.S. Kerosene Wholesale/Resale Price by Refiners



**Figure 2.11** Development of the fuel price from 1980 to 2021. Source: U.S. Energy Information Administration (EIA 2021)

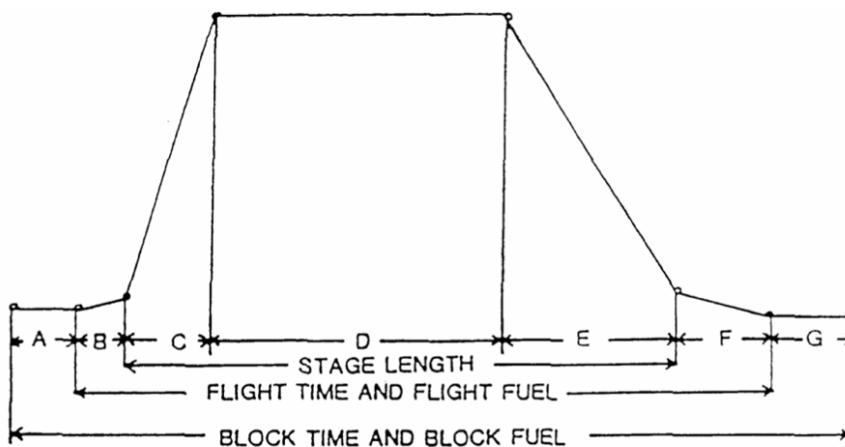
## Fuel Mass

The mass of the fuel consumed during a flight – fuel mass  $m_F$  – is calculated according to the methods outlined in 2.3.2. In doing so, it is crucial to clearly define the aircraft-trip, since the fuel costs calculation is always tied to a specific stage length, i.e., the range  $R$  between the departure and destination airport.

Figure 2.12 shows the definition of the aircraft trip according to the AEA methods. On top of the required trip fuel, certain fuel reserves are mandatory, and according to AEA (1989b) and AEA (1989a), the aircraft is to be filled with enough fuel so that:

- a 5% reserve additional to the required fuel is included,
- in addition, an alternative airfield at a distance of 250 NM could be reached,
- in addition, the aircraft could fly for 30 minutes in a holding pattern at 1500 ft with minimal drag.

Nevertheless, **only** the **consumed** fuel mass is included in the DOCs calculation according to flight phases A to G from Figure 2.12. Therefore, the fuel reserve only affects the fuel consumption due to additional aircraft weight.



- A. Start-up and taxi-out (20 min)  
 B. Take-off and initial climb to 1,500 ft.  
 C. Climb from 1,500 ft to initial cruise altitude.  
 D. Cruise at selected speed and altitude including any stepped climb required (min 4000 ft).  
 E. Descent to 1,500 ft.  
 F. 8 min. hold at 1,500 ft including APP and landing.  
 G. Taxi-in 5 min.

**Figure 2.12** Definition of the flight mission according to AEA 1989b (long-range). (Scholz 2015)

**Note:** according to AEA 1989a (short and medium-range), for flight phase A, only 10 minutes would have to be used.

### 2.4.2.5 Maintenance Costs

According to WATOG (1992), maintenance is defined as:

*“...Those actions required for restoring or maintaining an item in serviceable condition, including servicing, repair, modification, overhaul, inspection, and determination of condition.”*

A distinction is made between the following:

- scheduled maintenance -  $\approx 30\%$  of costs;
- unscheduled maintenance -  $\approx 70\%$  of costs;
- on-aircraft maintenance -  $\approx 30\%$  of costs;
- off-aircraft maintenance -  $\approx 70\%$  of costs;
- time-dependent maintenance (increased costs on long flights);
- cycle-dependent maintenance (increase costs in the case of many short flights as opposed to a few long flights).

Flight cycles are the number of flights made by an aircraft during a specific period. The calculation of maintenance costs depends mainly on the figures available, which in turn depend on how maintenance costs are recorded in a maintenance organization. In addition to the classifications stated above, the following distinctions are made:

- Direct Maintenance Costs, DMC – caused directly by the aircraft;
- Indirect Maintenance Costs, IMC – incurred by the operation of the maintenance organization, which cannot be allocated directly to the aircraft, e.g., training for the maintenance team.

The labor rate charged for one maintenance hour on the aircraft is called:

- *unburdened labor rate*: if only DMC elements are contained in the labor rate;
- *burdened labor rate*: if IMC elements are also included in the labor rate.

If the maintenance is carried out by the airline itself, then it is possible to differentiate between the *burdened* and *unburdened labor rate*. However, if other organizations carry out the maintenance work, the labor rate understandably also includes the IMC elements. Still, the maintenance expenses appear to the operator as costs caused directly by the aircraft. Therefore, it is difficult to differentiate between the *burdened* and *unburdened labor rate*. When calculating the DOC, the normal procedure is to select a labor rate containing a specific IMC proportion. The employed labor rate in relation to the maintenance man-hour, MMH,  $L_M$  is 195,01 US\$/h – typical value. (Scholz 2021b)

In general, maintenance costs comprise the labor costs  $C_{M,L}$  and the material costs  $C_{M,M}$



$$C_M = C_{M,L} + C_{M,M} , \quad (2.51)$$

or, are calculated from the maintenance hours  $t_M$

$$C_M = t_M L_M + C_{M,M} . \quad (2.52)$$

In this case, this is first interpreted as the costs incurred within one year:  $C_M = C_{M,a}$ .

$$C_M = t_{M,a} L_M + C_{M,M,a} \quad (2.53)$$

As a rule, the maintenance costs are related to the flight time  $t_f$ . It is then

$$C_{M,f} = t_{M,f} L_M + C_{M,M,f} , \quad (2.54)$$

and thus

$$C_M = (t_{M,f} L_M + C_{M,M,f}) t_f n_{t,a} . \quad (2.55)$$

Of course, it is difficult to estimate the maintenance hours and cost of materials for the aircraft as a whole in one step. For this reason, the maintenance costs for individual parts of the aircraft are calculated and then added together. In DOC methods, it is common to calculate the maintenance costs differentiating between airframe (Index:  $AF$ ) and engine (Index:  $E$ ). For maintenance of the airframe, wage costs account for roughly 65% and the cost of materials 35%. In the case of engine maintenance, the ratio is the opposite.

$$C_M = ((t_{M,AF,f} + t_{M,E,f}) L_M + C_{M,M,AF,f} + C_{M,M,E,f}) t_f n_{t,a} \quad (2.56)$$

With

$$t_{M,AF,f} = \frac{1}{t_f} \left( 9 \cdot 10^{-5} \frac{1}{kg} \cdot m_{AF} + 6.7 - \frac{350000 kg}{m_{AF} + 750000 kg} \right) \cdot (0.8h + 0.68t_f) , \quad (2.57)$$

$$C_{M,M,AF,f} = \frac{1}{t_f} \left( 4.2 \cdot 10^{-6} + 2.2 \cdot 10^{-6} \frac{1}{h} \cdot t_f \right) P_{AF} , \quad (2.58)$$

$$t_{M,E,f} = n_E \cdot 0,21 \cdot k_1 k_3 \cdot \left( 1 + 1,02 \cdot 10^{-4} \frac{1}{N} \cdot T_{T/O,E} \right)^{0,4} \cdot \left( 1 + \frac{1,3h}{t_f} \right) , \quad (2.59)$$

and

$$C_{M,M,E,f} = n_E \cdot 2.56 \frac{US\$}{h} \cdot k_1(k_2 + k_3) \cdot \left(1 + 1,02 \cdot 10^{-4} \cdot \frac{1}{N} \cdot T_{T/O,E}\right)^{0,8} \cdot \left(1 + \frac{1,3h}{t_f}\right) \cdot k_{INF} . \quad (2.60)$$

In Equations (2.56) to (2.60), the mass of the airframe is

$$m_{AF} = m_{OE} - m_{E,inst} . \quad (2.61)$$

The mass of all engines on the aircraft is

$$m_{E,inst} = k_E k_{thr} n_E m_E , \quad (2.62)$$

$k_E = 1.15$  for jet transports and engines in pods,

$k_{thr} = 1.00$  without reverse thrust,

$k_{thr} = 1.18$  with reverse thrust,

$n_E$  number of engines,

$m_E$  mass of one engine without parts used for engine integration

The take-off thrust of an engine  $T_{T/O,E}$  is calculated with

$$k_1 = 1.27 - 0.2 BPR^{0.2} , \quad (2.63)$$

$$k_2 = 0.4 \left(\frac{OAPR}{20}\right)^{1.3} + 0.4 , \quad (2.64)$$

$$k_3 = 0.032 n_C + k_4 , \quad (2.65)$$

and

$$k_4 = \begin{matrix} 0.50, n_s = 1 \\ 0.57, n_s = 2 \\ 0.64, n_s = 3 \end{matrix} . \quad (2.66)$$

The **engine data** contained in equations (2.63) to (2.66) can be taken from the literature or directly from the manufacturer's data. The following are required:

- the bypass ratio  $BPR$ .
- the overall pressure ratio  $OAPR$ .
- the number of compressor stages – including the fan  $n_C$ .
- the number of shafts of the engine  $n_S$ .

The equations (2.57) to (2.60) constantly adapt to the current financial conditions if the current labor rate and the current aircraft price are used. If equations provide costs relating to the year the method was developed, inflation compensation must be provided. This is carried out by means of an inflation factor.

$$k_{INF} = (1 + p_{INF})^{n_{year} - n_{method}} \quad (2.67)$$

**Note:** This factor has been added to Eqn. (2.60) compared to the AEA original (Scholz 2015). By doing this, the equation is then adjusted to the present financial conditions. The following are inserted in Eqn. (2.67):

- the annual mean inflation rate  $p_{INF}$
- the year for which the calculation is being made  $n_{year}$
- the year that the method refers to  $n_{method}$

For the AEA method,  $n_{method} = 1989$  according to its publication date, and  $p_{INF} = 0.033$  is appointed as a plausible value.

#### 2.4.2.6 Crew Costs

The crew costs  $C_{CREW}$  englobe the cabin crew costs  $C_{C,CA}$ , and the cockpit crew costs  $C_{C,CO}$ . Therefore

$$C_C = C_{C,CO} + C_{C,CA} \quad (2.68)$$

The crew is usually paid by block time, in which hourly rates are incurred. The cockpit crew  $n_{CO}$  are paid at a mean hourly rate  $L_{CO}$  and cabin crew  $n_{CA}$  at a mean hourly rate  $L_{CA}$ . The yearly cabin crew costs are thus calculated as follows

$$C_C = (n_{CO}L_{CO} + n_{CA}L_{CA})t_b n_{t,a} \quad (2.69)$$

As a rule of thumb, **one cabin crew** is assumed per **every 50 passengers**. Table 2.6 gives the hourly rates considered by the AEA 1989a and AEA 1989b. It strikes that these hourly rates may be significantly higher than those applicable today. Nevertheless, for a relative comparison of DOCs, these values can be used unchanged to make calculations.

**Table 2.6** Flight crew costs per hour in short and medium-range flight: AEA method; based on Scholz (2015)

	Short and medium-range US\$/h
AEA DOC method	
Cockpit crew, average value, $L_{CO}$	246,5
Cabin crew, average value, $L_{CA}$	81,0

### 2.4.2.7 Fees and Charges

The AEA method includes fees and charges  $C_{FEE}$  in the DOC calculation as they generally originate from the aircraft's operation. The following fees and charges are featured in a calculation:

- landing fees  $C_{FEE,LD}$  are incurred for using the airfield with its runways;
- air traffic control (ATC) or navigation charges  $C_{FEE,NAV}$  are incurred for the use of the airways, radio navigation, and direction by air traffic control;
- ground handling charges  $C_{FEE,GND}$ , which may include:
  - ground service related to services connected with passengers, luggage, cargo, and post, as well as landing, unloading, provisioning, and cleaning;
  - pulling, parking, and starting the aircraft;
  - information and documentation services;
  - technical services like refueling and filling up with other fluids, de-icing and maintenance (rectifying minor defects); flight advisory services.

The costs incurred due to ground handling should be assigned to the IOC according to general opinion unless they are affected by specific design parameters of the aircraft. Nevertheless, the AEA method also includes the  $C_{FEE,GND}$  in the DOCS for simplicity's sake and with little differentiation.

The following  $C_{FEE}$  are then incurred per year

$$C_{FEE} = C_{FEE,LD} + C_{FEE,NAV} + C_{FEE,GND} \quad . \quad (2.70)$$

The cost elements of fees and charges are calculated according to the following equations

$$C_{FEE,LD} = k_{LD} m_{MTO} n_{t,a} k_{INF} \quad , \quad (2.71)$$

$$C_{FEE,NAV} = k_{NAV} R m_{MTO} n_{t,a} k_{INF} \quad , \quad (2.72)$$

$$C_{FEE,GND} = k_{GND} m_{PL} n_{t,a} k_{INF} \cdot \quad (2.73)$$

Equations (2.71) to (2.73) have been created by first calculating the fees and charges for an individual flight and then multiplying by the number of flights per year, thus representing the annually incurred fees and charges. Since fixed costs are calculated in US\$, which is subject to inflations, it is necessary to adjust the current cost level with the inflation factor (2.67). An inflation rate for the fees and charges of 6.5% is a plausible value.

Following **constatations** apply: the landing fees depend on the MTOW; the ATC charges depend on the flight distance and the MTOW; the ground handling charges depend on the payload.

The other parameter of equations (2.71) to (2.73) are presented in Table 2.7.

**Table 2.7** Parameter for the calculation of fees and taxes

Source	$k_{NAV}$ US\$/kg	$\frac{k_{NAV}}{nm\sqrt{kg}}$ US\$	$k_{GND}$ US\$/kg	$p_{INF}$
AEA 1989a	0.0078	0.00414	0.10	6,5
AEA 1989b	0.0059	0.00166	0.11	6,5

#### 2.4.2.8 Calculation of Aircraft Utilization

So far, it has been assumed that the number of flights per year  $n_{t,a}$ . This parameter is of great importance since it sets the number of times the individual flight costs are to be multiplied in order to obtain the annual operating costs.

If a large number of flights are carried out each year with an aircraft, then the fixed costs (depreciation, interest, insurance) are distributed over more flights so that the individual flight is burdened with fewer costs. The question is how many flights per year can be managed – or, more precisely, how many flight hours can be carried out with an aircraft in a year. The number of flight hours carried out in a defined period is called flight utilization  $U$ . There is a fixed correlation, via the flight time, between the number of flights per year and the aircraft utilization.

The number of flight hours (FH, Index:  $f$ ) flown annually gives the annual aircraft utilization  $U_{a,f}$ , calculated with

$$U_{a,f} = t_f n_{t,a} \cdot \quad (2.74)$$

$t_f$  is the flight time already defined above.

With the number of flights per year  $n_{t,a}$  the number of flights or trips (Index: t) during a different period can be calculated

$$\text{Trips daily} \quad n_{t,d} = n_{t,a}/365 \quad ; \quad (2.75)$$

$$\text{Trips hourly} \quad n_{t,h} = n_{t,d}/24 = n_{t,a}/(365 \cdot 24) \quad ; \quad (2.76)$$

and also the aircraft use in relation to the flight time, Index:  $f t_f$ :

$$\text{Daily utilization} \quad U_{d,f} = t_f n_{t,d} \quad ; \quad (2.77)$$

$$\text{Hourly utilization} \quad U_{h,f} = t_f n_{t,h} \quad . \quad (2.78)$$

The number of block hours (BH, Index: b) flown annually gives the annual utilization  $U_{a,b}$ , calculated with

$$U_{a,b} = t_b n_{t,a} \quad . \quad (2.79)$$

The number of flights during another period can also be calculated here:

$$\text{Daily utilization} \quad U_{d,b} = t_b n_{t,d} \quad ; \quad (2.80)$$

$$\text{Hourly utilization} \quad U_{h,b} = t_b n_{t,h} \quad . \quad (2.81)$$

Annual aircraft utilization (hours per year) and daily utilization (hours per day) are common parameters in practice. Calculations can be made especially easy with the dimensionless hourly aircraft utilization or relative aircraft utilization.

The AEA methods provide calculation equations for aircraft utilization and make it possible to make a conclusive DOC **comparison between** different **aircraft** and aircraft trips. All these calculation equations for annual aircraft utilization have the same structure

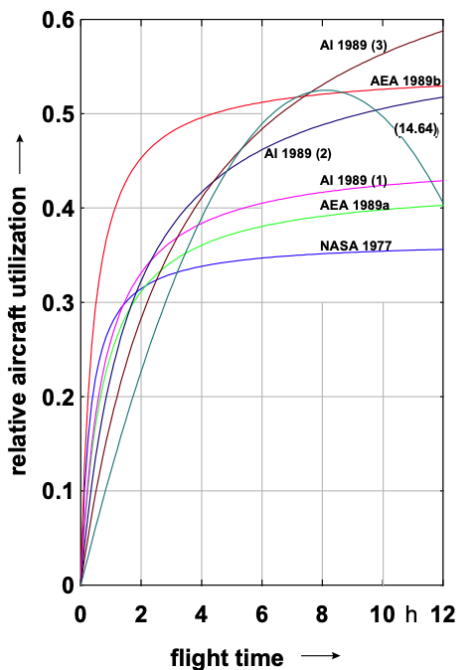
$$U_{a,f} = t_f \frac{k_{U1}}{t_f + k_{U2}} \quad . \quad (2.82)$$

The only differences between the calculation equations are the parameters  $k_{U1}$  and  $k_{U2}$ . These parameters are stated in Table 2.8.

**Table 2.8** Parameters for the calculation of the aircraft utilization according to Eqn. (2.82)

Source	$k_{U1}$ $h$	$k_{U2}$ $h$
AEA 1989a	3750	0.750
AEA 1989b	4800	0.420

The relative flight utilization  $U_{h,f}$  calculated with the aid of the parameters from Table 2.8 is shown in Figure 2.13. According to this graph, aircraft utilization increases when the flight time does. This corresponds to the practical experience: *a large number of short flights causes more ground times than a few long flights*. Therefore, *more flight hours can be flown with fewer but longer flights*.

**Figure 2.13** Relative aircraft utilization calculated according to Eqn. (2.82) (Scholz 2015)

### 2.4.3 Calculation of the DOC with the TU Berlin Method

The TU Berlin DOC is a more recent DOC and was developed by the Institute of Aeronautical Engineering of the Technical University of Berlin. The theoretical knowledge regarding this method was retrieved in a presentation held by Scholz (2013) at the 3<sup>rd</sup> Symposium on Collaboration in Aircraft Design – in which some additional remarks were added.

This method distinguishes between the route independent (fixed) costs,  $C_1$ , and the route dependent (variable) costs,  $C_2$ . The corresponding equation is given in Eqn. (2.83).

$$DOC = C_1 + C_2 \quad (2.83)$$

$C_1$  englobes the capital costs and the crew costs, as shown in Eqn. (2.84).

$$C_1 = C_{CAP} + C_{CREW} \quad (2.84)$$

$C_{CAP}$  contemplates the interest, depreciation, and insurance costs which can be calculated with Eqns. (2.85) and (2.86)

$$C_{CAP} = [P_{OEW} \cdot (OEW - W_{Eng} \cdot N_{Eng}) + W_{Eng} \cdot N_{Eng} \cdot P_{Eng}](a + f_{Ins}) \quad , \quad (2.85)$$

$$a = IR \cdot \frac{1 - f_{RV} \cdot \left(\frac{1}{1+IR}\right)^{DP}}{1 - \left(\frac{1}{1+IR}\right)^{DP}} \quad , \quad (2.86)$$

Being,

$a$ : annuity factor;

$P_{OEW}$ : price per kg of OEW – 1150€/kg);

$P_{ENG}$ : price per engine weight – 2500€/kg;

$IR$ : interest rate – 5%;

$DP$ : depreciation period;

$f_{RV}$ : residual value factor (Residual value/aircraft price, 10%);

$f_{Ins}$ : insurance rate – 0,5%);

$N_{Eng}$ : number of engines;

$W_{Eng}$ : weight per engine.

The costs for the cockpit and cabin crew are calculated with Eqn. (2.87)

$$C_{Crew} = CC \cdot (S_{FA} \cdot n_{FA} + S_{FC}) \quad , \quad (2.87)$$

being,

$n_{pax}$ : number of passengers;

$S_{FA}$ : average yearly salary of a flight attendant – 60,000€/yr;

$S_{FC}$ : average yearly salary of a cockpit crew – 300,000€/yr for two pilots

$CC$ : cabin crew complement (number of crews per aircraft) – 5

$N_{FA}$ : number of flight attendants – one for every 50 passengers.



$C_2$  englobes the costs related to the fuel, lubricants, fees, and maintenance. The corresponding equation is given in Eqn. (2.88).

$$C_2 = FC \cdot \left( P_F \cdot TF + P_{PL} \cdot PL + P_L \cdot MTOW + f(R) \cdot R \cdot \sqrt{\left(\frac{MTOW[to]}{50}\right) + MC} \right) \quad (2.88)$$

It is,

$FC$ : yearly flight-cycles

$P_F$ : fuel price [0,40 US\$/kg] (see 2.4.2.4)

$TF$ : trip fuel [kg]

$P_{PL}$ : handling fees – 0,1 €/kg

$PL$ : payload [kg]

$P_L$ : landing fees – 0,01 €/kg

$f(R)$ : range dependent ATC price factor – 1,0 for domestic Europe, 0,7 for transatlantic flights, and 0,6 for far east flights;

$R$ : range [km]

$MC$ : maintenance cost per flight cycle

For the calculation of the maintenance costs, Eqns. (2.89) to (2.92) are utilized.

$$MC_{AF,MAT} = OEW[to] \cdot (0.21 \cdot FT + 13.7) + 57.5 \quad (2.89)$$

$$MC_{AF,PER} = LR \cdot (1 + Burden) \{ (0.655 + 0.01 \cdot OEW) \cdot FT + 0.254 + 0.01 \cdot OEW \} \quad (2.90)$$

$$MC_{ENG} = N_{ENG} (1.5 \cdot SLST[to] + 30.5 \cdot FT + 10.6) \quad (2.91)$$

$$MC = MC_{AF,MAT} \cdot MC_{AF,PER} \cdot MC_{ENG} \quad (2.92)$$

$MC_{AF,MAT}$  corresponds to the airframe material maintenance costs (repair and replacement), whereas  $MC_{AF,PER}$  contemplates the airframe personnel maintenance cost (inspection and repair), and lastly,  $MC_{ENG}$  englobes the engine total maintenance costs, being:

$Burden$ : cost burden – 2;

$FT$ : flight time;

$LR$ : labor rate – 50€/h or around 56,6 US\$/h;

$SLST$ : sea level static thrust of one engine [tonnes].

The yearly flight-cycles are calculated with the help of Eqns. (2.93) and (2.94).

$$FC = \frac{OT_{p.a.}}{FT + BT} = \frac{OT_{p.a.}}{\frac{R}{v} + BT} , \quad (2.93)$$

$$OT_{p.a.} = POT_{p.a.} - DT_{p.a.} , \quad (2.94)$$

with,

- $OT_{p.a.}$ : yearly operation time;  
 $POT_{p.a.}$ : potential yearly operation time –  $365 \cdot 24\text{h} = 8760 \text{ h}$ ;  
 $DT_{p.a.}$ : yearly forced downtime – 2748,8 hours consisting of C-Checks (3,2 days p.a); D-Checks (5,6 days p.a); Repairs (2,6 days p.a., statistical average); and night curfew (7 days p.a., from 11:00 p.m. until 6:00 a.m. at operation days);  
 $FT$ : flight time;  
 $BT$ : block time supplement per flight – 1,83 hours (statistical average);  
 $R$ : stage length;  
 $V$ : cruise speed.

**Note:** It is hereby assumed that the flight is performed with constant speed, which is not the actual case.

#### 2.4.4 Implementation of Excel Tools

To facilitate and automate the calculation and visualization of the direct operating costs, Excel tools have been employed in this thesis.

For the DOC assessment with the AEA method, the DOC calculation file from the PreSTo preliminary sizing tool developed by the AERO Group of the University of Applied Sciences Hamburg was employed (Scholz 2021b). For the calculations based on the TU Berlin method, an own Excel tool was programmed based on the presentation previously mentioned

Figure 2.14 shows the user interface of the PreSTo tool on the AEA method, whereas Figure 2.15 shows the user interface of own developed tool on the TU Berlin method. More detailed views can be retrieved in Appendix C.

Direct Operating Costs					
1. Input data from previous design phases					
Number of engines	$n_E$	<input type="text" value="2"/> [-]	Airframe mass	$m_{AF}$	<input type="text" value="37000"/> [kg]
Take-off thrust of ONE engine	$T_{T/O,E}$	<input type="text" value="130,00"/> [kN]	Payload mass	$m_{PL}$	<input type="text" value="14600"/> [kg]
Max. Take-off mass	$m_{MTO}$	<input type="text" value="85500"/> [kg]	Baggage mass	$m_{Baggage}$	<input type="text" value="1400"/> [kg]
Operating empty mass	$m_{OE}$	<input type="text" value="43000"/> [kg]	Cargo mass	$m_{Cargo}$	<input type="text" value="1200"/> [kg]
Number of passengers	$n_{PAX}$	<input type="text" value="160"/> [-]	Passenger mass	$m_{PAX}$	<input type="text" value="12000"/> [kg]
Design range	$R$	<input type="text" value="5400"/> [km]	Fuel mass	$m_F$	<input type="text" value="18000"/> [kg]
Engines mass	$m_{E,inst}$	<input type="text" value="6000"/> [kg]			

**Figure 2.14** User interface of the PreSTo tool for calculating DOCs with the AEA method (Scholz 2021b)

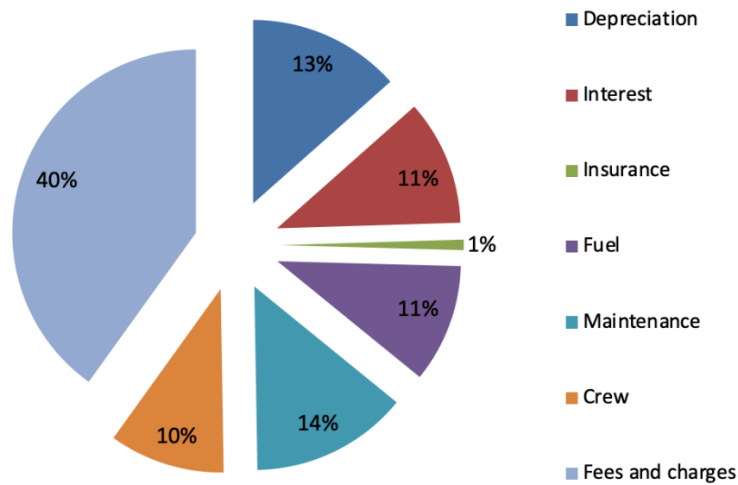
	Value	Unit
Aircraft	<b>A321LR</b>	
Number of PAX	160	-
Range (Mission)	5.600	km
MTOW	97.000	kg
MZFW	75.600	kg
OEW	51.900	kg
Mass Payload (max. : B)	23.580	kg
Mass Payload (Mission)	23.580	kg
Mass Pax (Mission)	15.520	kg
Mass Cargo (Mission)	8.060	kg
Mass Fuel (Mission)	21.400	kg
Flight Speed	850	km/h
Flight Time	6,6	h
SLST	145	kN
Engine Weight	3.000	kg
Nr. cabin crew	4	-
Cockpit crew hourly rate	246,5	US\$/h
Cabin crew hourly rate	81	US\$/h
Block Time	1,83	h
CC	5	

**Figure 2.15** User interface of own tool for calculating DOCs with the TU Berlin method

## 2.4.5 Visualization of the Direct Operating Costs

While expressing the DOCs and their distribution, it is sensible to employ charts, e.g., pie charts, to help visualize them. A generic example is shown in Figure 2.16.

## Direct Operating Costs



**Figure 2.16** DOC distribution visualization (Scholz 2021b)

## 2.5 Flight Haul

The definition of the flight haul addresses the classification of flights according to their duration and or distance. As of today, there is no unified standard for the single categories, so that the definitions vary for different organizations and airlines. EUROCONTROL (2005), the agency responsible for the air navigation in Europe, refers the to following classification:

- *Short-haul* corresponds to flights with an airport-to-airport distance of 1.500 km
- *Medium-haul* corresponds to flights with an airport-to-airport distance between 1.500 km and 4.000 km
- *Long-haul* corresponds to flights with an airport-to-airport distance of greater than 4.000 km

This classification is, from a practical point of view not applicable to every continent since most flights within Europe are relatively shorter than transatlantic flights, as well as most international flights within America, Africa, and Asia. Nowadays, it is widely accepted that flight hauls are categorized according to the flight duration, in order to be more accurate.

The classification considered in this thesis is as follows (Mottfitt 2020):

- *Short-haul* corresponds to flights with a duration up to 3 hours;
- *Medium-haul* corresponds to flights with a duration between 3 and 6 hours;
- *Long-haul* corresponds to flights with a duration greater than 6 hours.

## 2.6 Aircraft Considered for Comparisons

The data regarding the aircraft present in this thesis was retrieved from the corresponding document on the ACAMP, if not indicated otherwise. The information about the A321 family is stated on Airbus (2020) and about the A330-900neo in Airbus (2021c). To ascertain the different load and ranges for each aircraft, the payload-range diagrams present in the referred ACAMP were interpreted – see Appendix D. The aircraft of the A321 family all share the exact cabin dimensions.

### A321ceo

The Airbus A321ceo (Current Engine Option) is the least recent aircraft amongst the considered ones. It is based on the pioneer version of the A320 family and made its first commercial flight in April 1997 (Hardiman 2021). The version referred to in this thesis is the **A321-200 WV072**, since starting from 2002, all delivered models are A321-200s. It has an MTOW of 89.000 kg, an MPL of 23.600 kg, and a range at the design points B and C of 3700 km and 4200 km, respectively. This aircraft figures two older engines of the older models CFMI CFM-56-5B or IAE V-2533-A5, and it can transport up to 220 passengers in a single class cabin configuration or 170-200 passengers in a dual-class cabin configuration.

### A321neo

The Airbus A321neo (New Engine Option) was developed based on the base A321ceo aircraft. This aircraft, as the name suggests, offers new engine models, which can be the CFM LEAP-1A or the Pratt & Whitney PW1100G. According to Airbus (2021d), these engines provide seat fuel improvements of 20%, along with an additional range of up to 500 nm or two tonnes of extra payload. The first delivery of this aircraft took place on April 20<sup>th</sup> of 2017, to Virgin America. The version referred to in this thesis is the **A321neo WV0053**, and it has an MTOW of 93.500 kg, an MPL of 25.000 kg, and a range at the design points B and C of 4.630 km and 4.990 km, respectively. The A321neo is capable of carrying up to 23.490 liters of fuel in its base version. In a single-class cabin configuration, this aircraft can transport up to 244 passengers in a single-class or 220 passengers in a dual-class cabin configuration.

### A321LR

The Airbus A321neo LR constitutes the main scope of this thesis. It is the youngest aircraft of the A320 family in operation, and its first delivery took place on the 13. November 2018 (Airbus 2018a). The present data refer to the version **A321neo WV072 (ACF)** of this aircraft – see Appendix E. The LR is an extended-range variant of the A321neo, and it features three additional center tanks (ACT) with a capacity of 3121 liters each, making a total of 32.853 liters

of fuel. Like the A321neo, this aircraft features the new engines (PW1100G or LEAP-1A) while having similar cabin seating capacities. It has an MTOW of 97.000 kg, an MPL of 23.540 kg, and a range at the design points B and C of 5.600 km and 7.400 km, respectively. The design ranges of this aircraft are the basis for the use cases established in the thesis.

### A321XLR

The Airbus A321neoXLR is a further extended-range variant of the A321neoLR. The official launch of the XLR took place in 2019 at the Paris Air Show, and the aircraft is expected to enter service in 2023 (Airbus 2019c). The aircraft will feature an additional Rear Center Tank (RCT) with 12.900 liters of fuel capacity in addition to the ACTs, extending the total fuel capacity up to around 40.000 kg. The XLR will offer the same engine options as the LR and the neo, as well as similar cabin capacities to the LR. The projected MTOW is around 101.000 kg, and the range at MFW is 8.700 km (Airbus 2019c).

Based on the available information, an MPL of 22.300 kg and a range at MPL of 6.750 km are estimated – see Appendix F. Sensible assumptions for the MZFW, OEW, and ferry range were made since there is still no published payload-range diagram for this aircraft – also explained in Appendix F.

### A330-900neo

The Airbus A330-900neo is a twin-aisle aircraft and has the same fuselage as its base model, the A330-300, which entered service in January 1994 (Bodell 2020). The A330-900neo is equipped with two Rolls Royce Trent 7000-72 engines (New Engine Option), and the first delivery, to TAP Air Portugal, took place in November 2018 (Airbus 2018b) – the first commercial happened one month later. The data present in this thesis takes version **A330-900 (neo) WV900 (d)** into account. This version has an MTOW of 242.000 kg, an MPL of 45.400 kg, and a range at the design points B and C of 7700 km and 8900 km, respectively. This aircraft has a maximum fuel capacity of around 139.090 liters.

Table 2.9 shows a summary of the weights and ranges regarding all aircraft. The values with (\*) constitute estimates (see Appendix F).

**Table 2.9** Weights and ranges of the considered aircraft

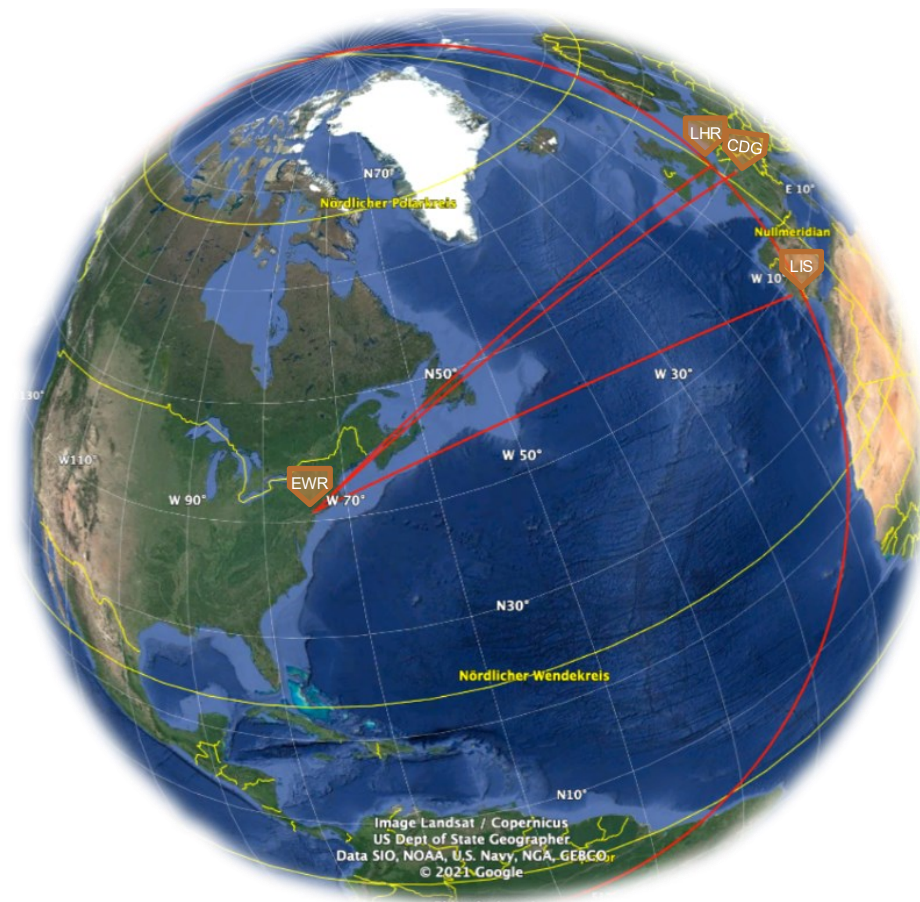
AIRCRAFT	MTOW [kg]	MZFW [kg]	OEW [kg]	MFW [kg]	Max. Payload [kg]	Range(B) [km]	Range(C) [km]	Range(D) [km]
A321ceo	89.000	71.500	48.436	18.600	23.571	3.704	4.198	5.865
A321neo	93.500	75.600	50.774	18.440	25.000	4.630	4.990	6.960
A321LR	97.000	75.600	52.060	25.790	23.540	5.600	7.400	9.400
A321XLR	101.000	74.374*	52.660*	31.016	22.314*	6.750*	8.700	11.800*
A330-900 neo	242.000	181.000	135.640	109.186	45.360	7.700	8.900	17.287

## 2.7 Use Cases or Missions Considered

The Missions considered in this thesis are based on the design ranges of the A321LR since they represent the most sensible use cases and limits for this aircraft and are therefore guidelines for the aircraft's operators:

- Mission 1 (M1) coincides with the range at point B, at MPL, of the LR – 5.600 km
- Mission 2 (M2) is equidistant to the ranges at points B and C of the LR – 6.500km
- Mission 3 (M3) coincides with the range at point C, at MFW, of the LR – 7.400 km

### M1 – 5600 km



**Figure 2.17** Destination airports departing from EWR within a 5.600 km flight radius (GoogleEarth Pro 2021)

Figure 2.17 shows possible routes departing from the Newark Liberty International Airport in New York (EWR) as the flight radius (in red) extends up to 5.600 km. Some destination airports in the west and south Europe are, for example, the London Heathrow Airport (LHR), the Paris Charles-de-Gaule Airport (CDG), and the Lisbon Portela Airport (LIS). Within this range, destinations in the northern part of South America and archipelagos in the Atlantic Ocean, e.g.,

the Cape Verde Islands and the Canary Islands, are also included. Furthermore, while departing from EWR, the whole North American continent can be covered.

With an average cruise speed of 850 km/h, an overhead flight time of around six hours and thirty-five minutes (6h35), and a total flight time of at least seven hours and five minutes (7h05) is estimated for the LR, assuming an additional 30 min for take-off and landing operations.

## M2 – 6500 km



**Figure 2.18** Destination airports departing from EWR within a 6.500 km flight radius (GoogleEarth Pro 2021)

Figure 2.18 shows possible routes within a flight radius of 6.500 km once again while departing from EWR and shows that more destinations in Western Europe like Berlin (BER), Mallorca (PLM), and Stockholm (ARN) are now possible. Furthermore, some countries in the Maghreb region and West Africa, as well as more interior destinations in South America, are now reachable.

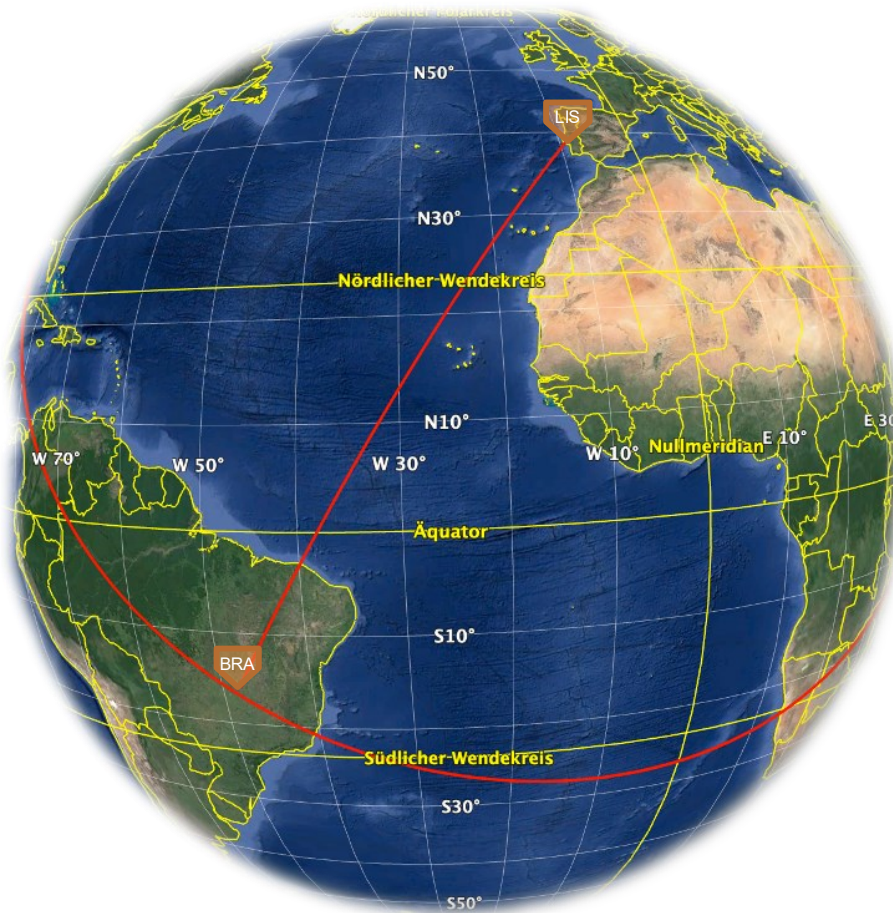


With an average cruise speed of 850 km/h, an overhead flight time of around seven hours and thirty-eight minutes (7h38), and a total flight time of at least eight hours and eight minutes (8h08) is estimated for the LR, assuming an additional 30 min for take-off and landing operations.

### M3 – 7400 km

Figure 2.19 shows a possible route departing from the Lisbon Portela airport to the Brazilian capital Brasil, which is at the moment only possible for the A320 family through the A321LR. Within this range – 7.400 km – TAP Air Portugal, one of the leading operators of the LR, can reach all continents from Lisbon (Pearson 2021a).

With an average cruise speed of 850 km/h, an overhead flight time of around eight hours and forty-two minutes (8h42), and a total flight time of at least nine hours and twelve minutes (9h12) is estimated for the LR, assuming an additional 30 min for take-off and landing operations.



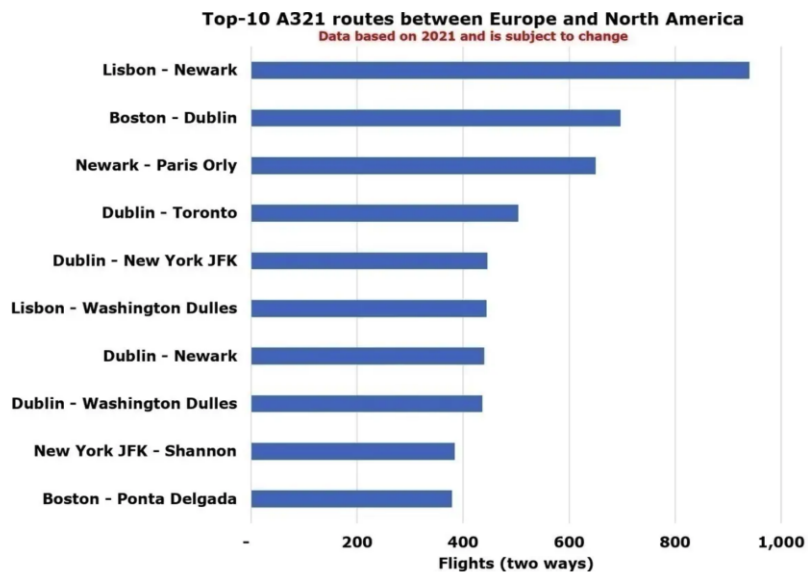
**Figure 2.19** Destination airports departing from LIS within a 7.400 km flight radius (GoogleEarth Pro 2021)

At least six airlines are planning to operate flights between Europe and America in the winter season 2021/2022, which is twice as many as those that plan to employ the Boeing 757, a direct competitor of the A321LR (Pearson 2021a). Table 2.10 gives an overview of some of the scheduled long-haul flights to be operated by the A321LR.

**Table 2.10** Scheduled long-haul flights operated by A321LR aircraft – winter season 2021/22 (edited from Pearson 2021a)

Airline	From	To	Distance (miles)	Distance (km)
TAP	Belém	Lisbon	3,726	6,000
Air Transat	Faro	Toronto	3,693	5,940
SAS	Boston	Copenhagen	3,671	5,910
TAP	Lisbon	Recife	3,628	5,840
TAP	Lisbon	Washington Dulles	3,592	5,780
Air Transat	London Gatwick	Toronto	3,576	5,750
Air Transat/ TAP	Lisbon	Toronto	3,576	5,750
Air Transat	Malaga	Montreal	3,554	5,720
Air Transat	Porto	Toronto	3,515	5,660
TAP	Lisbon	Natal	3,496	5,630
TAP	Fortaleza	Lisbon	3,478	5,600
JetBlue	London Gatwick	New York JFK	3,47	5,580
JetBlue	London Heathrow	New York JFK	3,451	5,550
Air Transat	Montreal	Paris CDG	3,442	5,540
Air Transat	Manchester	Toronto	3,434	5,530
Aer Lingus	Dublin	Washington Dulles	3,404	5,480
TAP	Lisbon	Newark	3,384	5,450
TAP	Lisbon	New York JFK	3,366	5,420
Aer Lingus	Manchester	New York JFK	3,341	5,380
Air Transat	Glasgow	Toronto	3,293	5,300

Complementing this information, Figure 2.20 gives the ten most frequent routes between Europe and North America in 2021.



**Figure 2.20** Top ten A321 routes between Europe and North America in 2021, according to number of flights (Pearson 2021b)

## 2.8 Passenger Mass Considered

According to Roskam (1989), an average passenger mass ( $m_{pax}$ ) of 93,0 kg can be assumed for short- and medium-haul flights or **97,5** for long-haul flights. These masses already include the baggage carried by the passenger, which is appointed to be 13,6 kg or 18,1 kg, respectively.

Since a great part of the use cases present in this thesis address long-haul flights, a corresponding  $m_{pax}$  will be used. For the sake of simplicity, 97 kg was chosen as  $m_{pax}$ .

**Note:** the values suggested by Roskam (1989) are employed in the preliminary design of aircraft and are therefore conservative. For this matter, 97 kg appears as a safe assumption, as airlines probably use a lower  $m_{pax}$  – e.g., according to EASA (2009), which appoints an average of 88,0 kg per passenger and luggage.

## 3 Fuel Consumption of the Airbus A321LR

This chapter addresses the Fuel Consumption of the Airbus A321LR. Further, it intends to establish comparisons with its immediate predecessors (A321ceo and A321neo), as well as with its upcoming successor (A321XLR) and with the flexible twin-aisled A330-900neo.

The required data for the Fuel Consumption calculation was retrieved from the respective aircraft's ACAMP (Airbus 2020, Airbus 2021c) and inputted into the Excel tool mentioned in Section 2.3.3 for all calculations. Finally, the results are presented according to the fuel consumption visualization methods given in Section 2.3.4.

The missions, i.e., use cases referred to in Chapter 2.7, constitute the main scope of the fuel consumption analyzed in the present chapter. Further, the complete flexibility of the A321LR's cabin is taken into account, as different airlines fly different cabin layouts (see Chapter 6 Cabin Layout of the Airbus A321LR)

**Note:** all curves herein presented are not plotted up until the given aircraft's ferry range to avoid representations plotted towards infinity. The same applies to the beginning of the curves, which usually start at 300 km instead of 0 km.

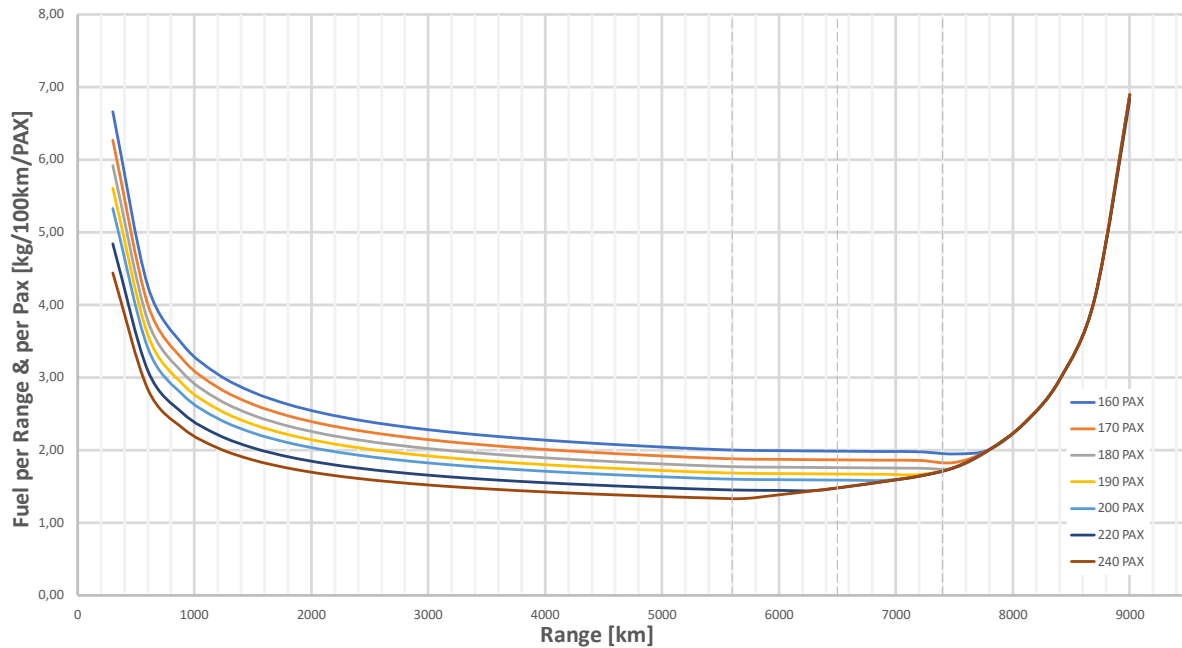
### 3.1 Assessment of the Fuel Consumption

#### 3.1.1 Bathtub Curve

Amongst the different ways to visualize an aircraft's fuel consumption, the fuel per range and passenger plays a significant role in the industry – *bathtub curve*. With this kind of visualization, a reasonable interpretation of the overall performance of the aircraft's fuel consumption is possible, as it allows taking different cabin layouts and/or ranges into account.

Figure 3.1 shows the resulting fuel consumption per 100 kilometers and passenger over the flown distance for the Airbus A321LR regarding different cabin layouts. The fuel consumption is therefore expressed in kg/100km/pax. The range of the previously defined missions is marked with traced lines (M1:5.600km(B); M2:6.500km; M3:7.500km(C)) – see Chapter 2.7.

**Note:** from the moment the slope of the curve is inverted, the range is not supported anymore with the corresponding number of pax: **a passenger reduction must take place.**



**Figure 3.1** Fuel consumption per range and passenger over flown distance for the A321LR – bathtub curve

As expected, the more passengers are transported, the smaller the fuel consumption distributed over the passengers is. The fuel consumption varies between approximately 6,7 and 1.30 kg/100km/pax from lowest to highest cabin density configuration, representing a variation of ca. 81%. The step-change for each additional ten passengers represents fuel savings of around 0,8 kg/100km/pax (11.6%).

When approaching the ferry range (starting at ca. 7.800km), the fuel consumption per range and passenger head towards infinity for all curves, as the passenger reduction occurs.

On the other hand, the effect of the fuel fractions presented in Chapter 2.2 can be observed for ranges under 1000 km. Here the fuel consumption is relatively high due to the high fuel consumption at take-off. With increasing range, the fuel consumption is then better distributed over the flown distance. Thus, between 300 and 1.000 km, a fuel consumption reduction of around 51% is observed.

This decreasing trend is generally maintained until the range at MPL (point B) of the aircraft, meaning 5.600 km. For farther ranges, sensible fuel consumption is only possible with reduced maximum capacity – less than 240 pax. In a cabin layout with up to 180 pax, the range at MFW of the aircraft (point C, at 7.400 km) can still be flown in a productive manner.

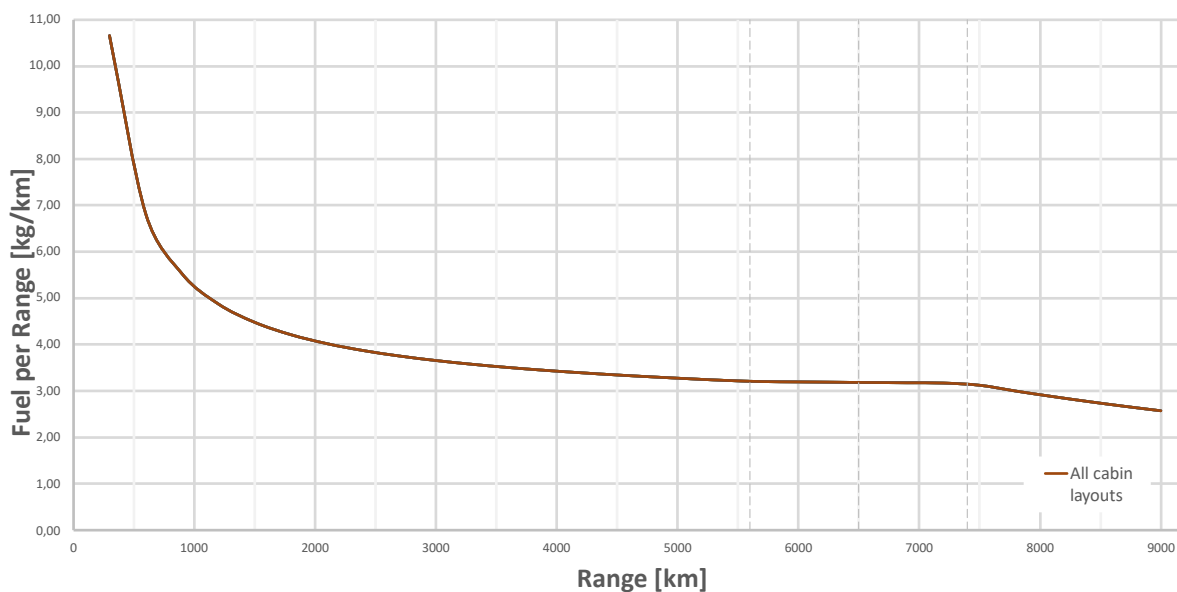
The curvature of every curve starts sooner or later to change. This point represents the point of the trade-off between more range and fewer passengers for the respective curve. In other words, the fuel consumed is then being distributed to a decreasing number of passengers up until it cannot be divided by any passenger anymore (infinity).

The lowest fuel consumption for a 160 pax cabin is reached at 7.800 km with 1.9 kg/100km/pax. With increasing cabin density, the respective fuel consumption decreases, and the minimum occurs at ranges shorter than the one from the 160 pax cabin. For a standard cabin of 200 pax, the lowest fuel consumption is 1,6 kg/100pax/km and occurs before the range of point C at around 6.800 km.

### 3.1.2 Fuel per Range over Range

Figure 3.2 shows the resulting fuel consumption of the A321LR per kilometer over the flown distance (range). Therefore, the fuel consumption is expressed in kilograms per kilometer versus kilometer (kg/km/km). By doing this, all curves coincide in a single one, as the curve is the same for all cabin configurations.

The resulting curve has a monotonic falling character, and the slope inherits a lower gradient after the fuel employed on take-off is stabilized – from 1.000 km to 7.400 km. After the range at MFW (point C), the fuel consumption falls again in a linear manner and higher rate until reaching the ferry range.

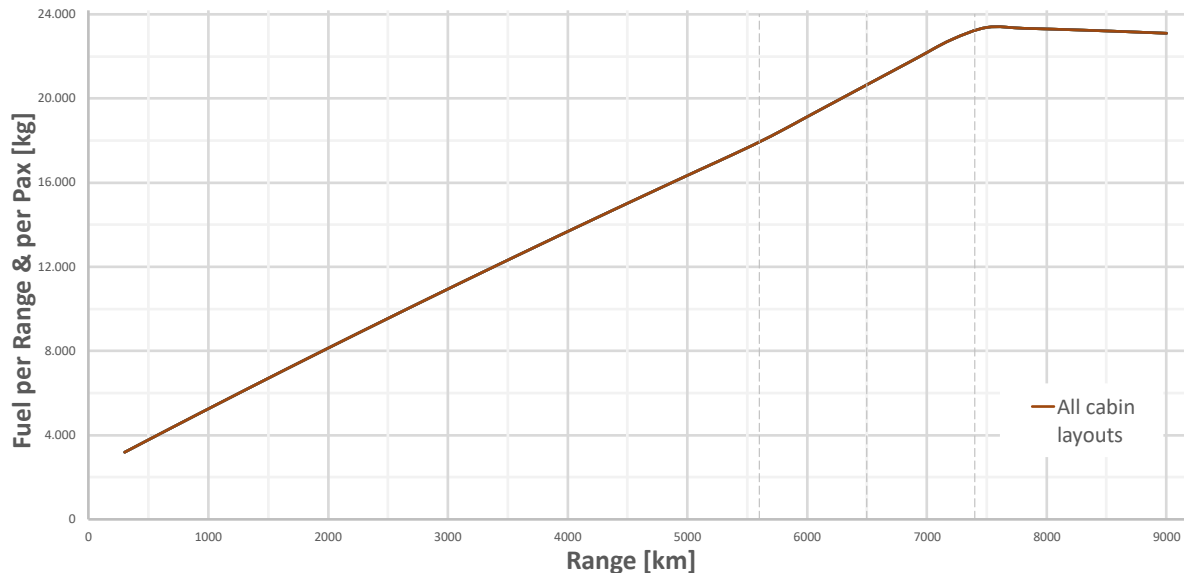


**Figure 3.2** Fuel consumption per range over flown distance for the A321LR – all cabin layouts

From 300 km to 1000 km, the fuel consumption per kilometer falls from 10,7 kg/km to 5,3 kg/km representing a 50% decrease. At 2.000 km, the fuel consumption is further reduced by 62%. Between 2.000 km and 7.400 km the relative fuel consumption reduction is “only” 22% (to 3,10 kg/km), representing a mean falling rate of 0,17 kg/km per each 1.000 km (4,1% per 1.000 km). Starting from point C (7.400 km), the mean falling rate raises to 0,5 kg/km per 1.000km (12,3% per 1.000 km).

### 3.1.3 Total Fuel over Range

Figure 3.3 represents the total fuel consumed over the flight by flown distance. Therefore, the fuel consumption is here expressed in kilograms per kilometer (kg/km).



**Figure 3.3** Fuel consumption over flown distance for the A321LR – all cabin layouts

This representation implies that the aircraft's fuel tanks will be theoretically emptied when the ferry range is reached.

The curve has an almost linear, increasing slope until the range of point C. The slope in the first 1000 km has a higher gradient than in the rest of the curve. After reaching point C, with a further reduction of the payload, the fuel consumption changes at a lower rate (almost constant) until the ferry range. Here the aircraft becomes gradually lighter, and its gliding properties get more evident.

## 3.2 Comparison with Other Aircraft

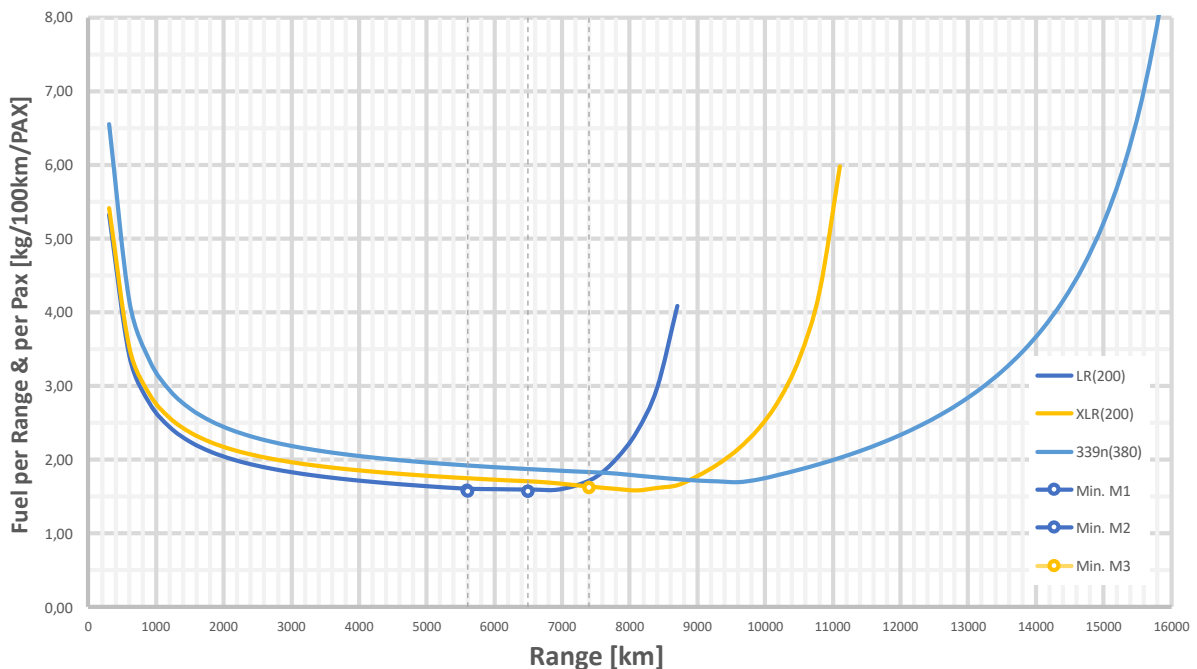
### Fuel per Hundred Kilometers and Passenger – Bathtub Curve

Afterward, the fuel consumption of the other considered aircraft was analyzed while regarding the missions mentioned in Chapter 2.6. By doing this, a direct comparison between the aircraft is then possible, and it illustrates whether it is sensible to employ an aircraft instead of another within a specific range. Furthermore, for a realistic comparison, only similar densities were

compared. Therefore, the comparison is divided into standard-, low-, and high-density cabin – the A321 family aircraft share a similar cabin, and a 380 passenger cabin is standard for the A330-900neo. The corresponding cabin layouts and the detected minimum for each mission are appointed for each case (cabin layout). The color of the minima corresponds to that of the aircraft. Again, the traced lines represent the missions previously mentioned (M1: 5.600 km; M2: 6.500 km; M3: 7.400 km).

**Note:** detailed charts for each aircraft can be found in Appendix G.

Figure 3.4 contains a comparative chart of all considered aircraft showcasing the resulting fuel consumption per hundred kilometers and passenger over the flown distance, regarding a standard density cabin configuration.



**Figure 3.4** Comparison of fuel consumption per range and passenger over the flown distance all the considered aircraft: standard density cabin; indicated minima

This chart starts to elucidate the use case particularities of each aircraft. The cabin density is, as mentioned, comparatively equal for all aircraft. Nevertheless, the curves clearly differ from one another.

First, it is evident that the aircraft show different operating ranges. Second, the A321LR and the A321XLR reveal similar fuel consumption until a specific range (7400 km), with the curves starting at almost the same level (between 5,3 and 5,4 kg/100km/pax). Between 900 km and 7.200 km, the LR shows slightly lower fuel consumption. After a flight distance of 7.400 km the XLR clearly proves to be more fuel-efficient. For example, at a range of 8.600 km the XLR consumes around 1,65 kg/100km/pax, whilst the LR consumes 4,1 kg/100km/pax (148% more).

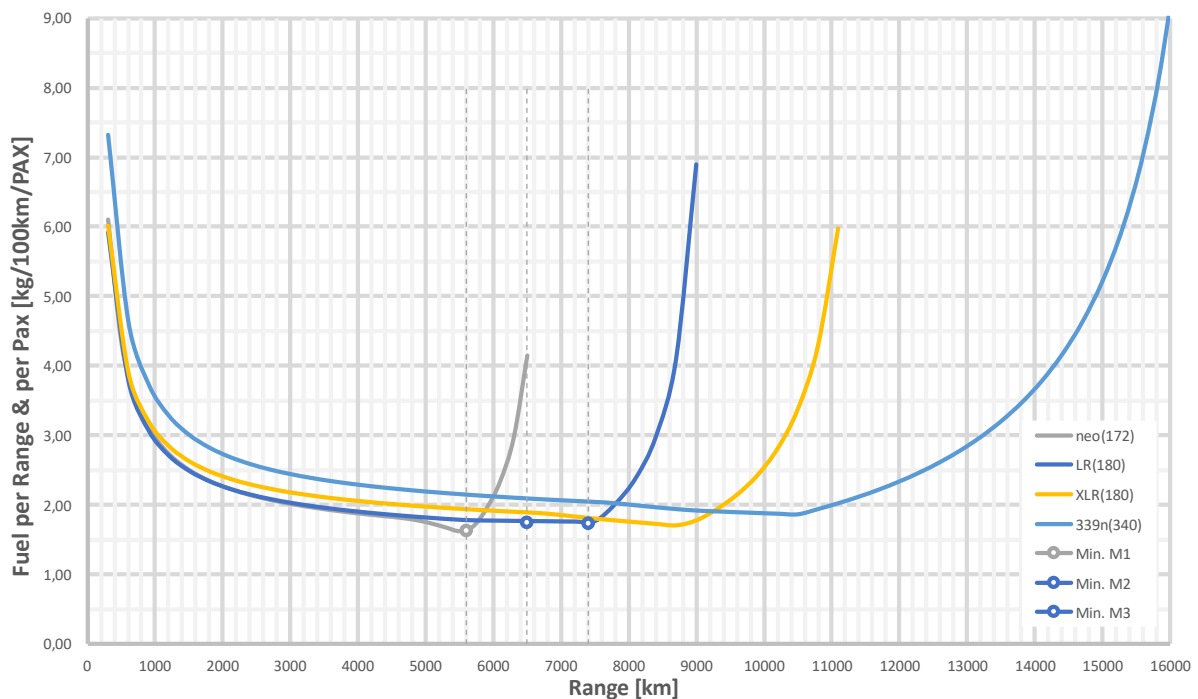


This happens because this point is far beyond the range of point C of the LR, and thus the payload has already been heavily reduced.

On the other hand, due to the considerably higher MTOW, the fuel consumption of the A330-900neo is generally higher, and its curve begins (for 300 km) at higher values –around 6,6 kg/100km/pax. This aircraft shows fuel consumption advantages for the current cabin configuration after a flown distance of around 8.700 km, where the XLR starts to exceed its capacities at MFW.

Furthermore, the indicated minima reveal which aircraft is more fuel-efficient at a given range while flying a standard density cabin configuration. For missions up to 5.600 km (M1), the A321LR is the most fuel-efficient aircraft even though the A321XLR shows only minimal disadvantage (less than 9%). For missions up to 6.500 km (M2), the A321LR is still the best-indicated aircraft and conserves around the same advantage towards the XLR. For missions up to 7.400 km (M3), the A321XLR is more advantageous as it is now the most fuel-efficient aircraft with around 1,63 kg/100km/pax. It strikes that the indicated minima for all three missions oscillate slightly, and they are all situated at around 1,60 kg/100km/pax (2,5% variation).

Figure 3.5 contains a comparative chart of all considered aircraft showcasing the resulting fuel consumption per hundred kilometers and passenger over the flown distance, regarding a low-density cabin configuration.



**Figure 3.5** Comparison of fuel consumption per range and passenger over the flown distance all the considered aircraft: low-density cabin; indicated Minima

The fuel consumption of each aircraft is here generally slightly higher than that from the standard density cabin configurations since the consumed fuel is being distributed to fewer passengers.

Within the A321 family, the fuel consumption at 300 km is around 6,0 kg/100km/pax. The A321 family once more reveals similar fuel consumption up until a specific range, after which the next recent aircraft is more fuel-efficient. In the case of the A321LR and XLR, a commonality up to a range of 7.400 km is observed. After this point, the A321XLR is again more fuel-efficient. At the range of the previous example, 8.700 km, the A321XLR consumes around 1,7 kg/100km/pax, while the LR consumes 4,1 kg/100km/pax (more 141%).

In the case of the A330-900neo, the relative increase in fuel consumption is considerably higher when compared to the one from a standard cabin – with 40 fewer passengers. The fuel consumption at 300 km is respectively 7,3 and 6,6 kg/100km/pax, representing a variation of plus 10,6%. For the current cabin configuration, this aircraft shows fuel efficiency advantages towards the A321XLR after a flown distance of around 9.200 km – 300 km “later” compared to the standard cabin configuration.

For this configuration, the A321neo is the best indicated for ranges up to 5.400 km in terms of fuel consumption – at around 1,6 kg/100km/pax and 172 maximum passengers. For missions M2 and M3, the most fuel-efficient aircraft is the A321LR, even though the advantage towards the XLR in M3 is minimal (around 2,8%). In both cases, the lowest fuel consumption registered is at around 1,7 kg/100km/pax (LR).

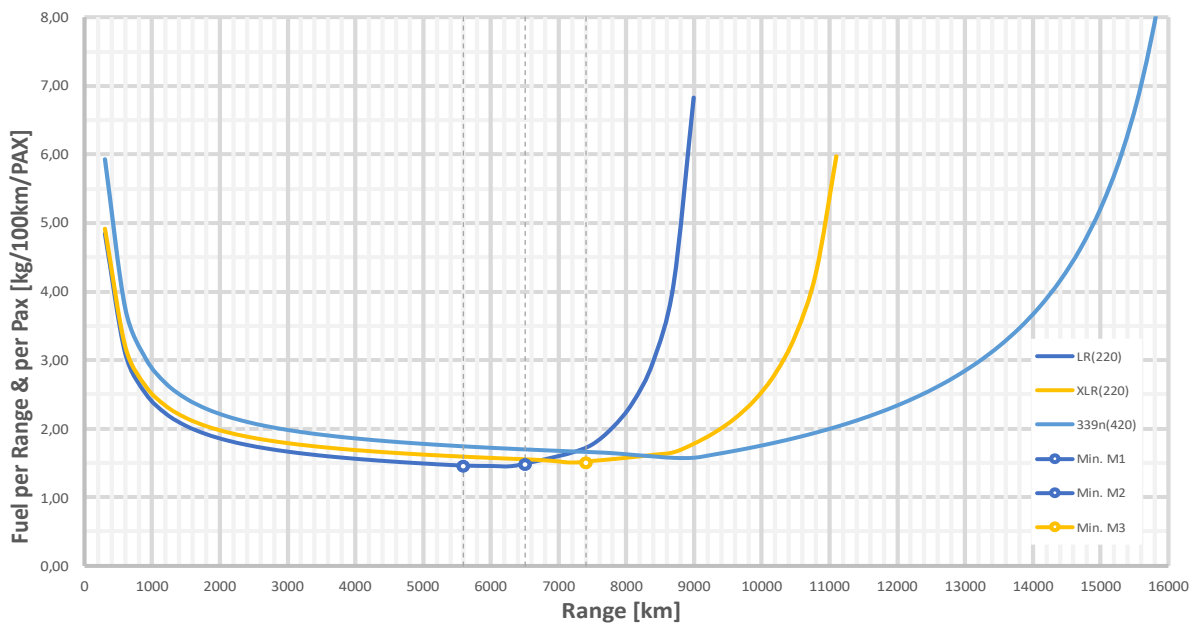
Lastly, Figure 3.6 contains a comparative chart of all considered aircraft showcasing the resulting fuel consumption per hundred kilometers and passenger over the flown distance regarding a high-density cabin configuration.

The fuel consumption of each aircraft is here generally lower than that from the standard density cabin configurations since the consumed fuel is being distributed to more passengers.

For the LR and XLR, the fuel consumption at 300 km is at around 4,9 kg/100km/pax. The commonality between these two aircraft is further maintained, up until 6800 km (the LR shows slightly lower fuel consumption). After this range, the A321XLR becomes more advantageous as its fuel consumption shows lower levels and maintains a slightly decreasing slope until 7.400 km.

In the case of a high-density cabin, at the range of the previous examples (8.700 km), even the A321XLR shows counterproductive fuel consumption as the slope of the curve already has a

positive gradient. Here, the A321XLR consumes around 1,7 kg/100km/pax, whilst the LR consumes 4,1 kg/100km/pax (more 148%).



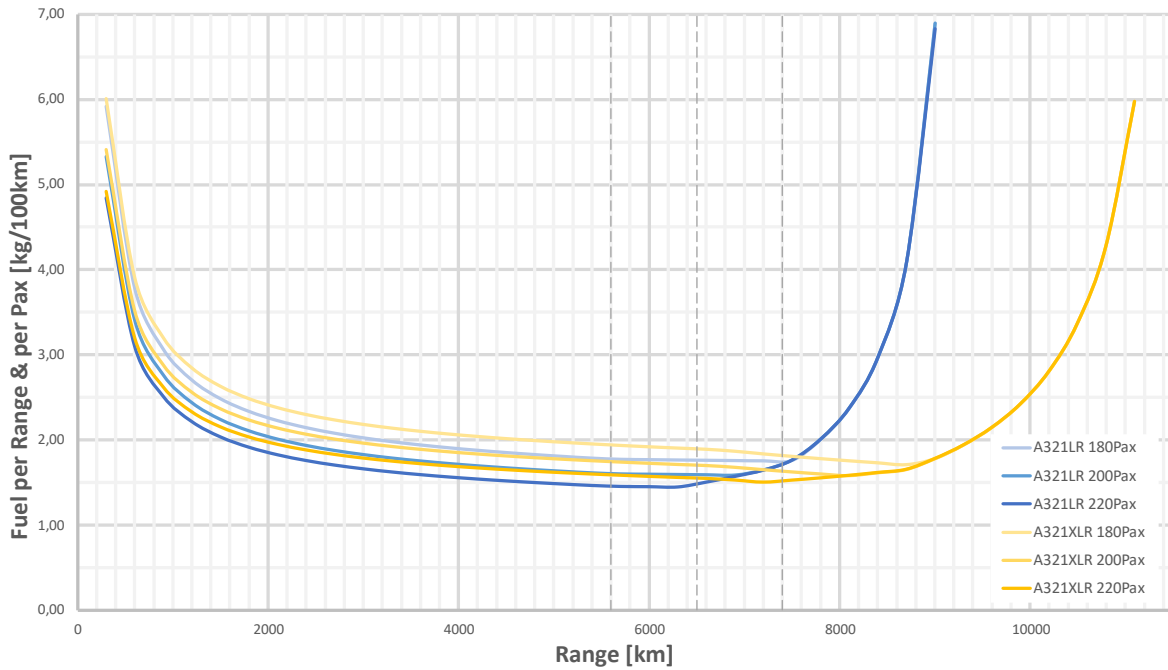
**Figure 3.6** Comparison of fuel consumption per range and passenger over the flown distance all the considered aircraft: high-density cabin; indicated minima

In the case of the A330-900neo, the relative decrease in fuel consumption is higher when compared to the one from a standard cabin – with 40 more passengers. The fuel consumption at 300 km is around 5,9 kg/100km/pax, representing a variation of minus 9,5% towards the standard cabin. For the current cabin configuration, this aircraft shows fuel efficiency advantages after a flown distance of around 8.200 km – 600 km “earlier” compared to the standard cabin.

For the first two considered missions, at 5.400 km and 6.500 km, the LR shows the lowest fuel so far, at around 1,45 and 1,5 kg/100km/pax, respectively – also lower than the XLR. The minimum for M3 is reached by the XLR at around 1,5 kg/100km/pax

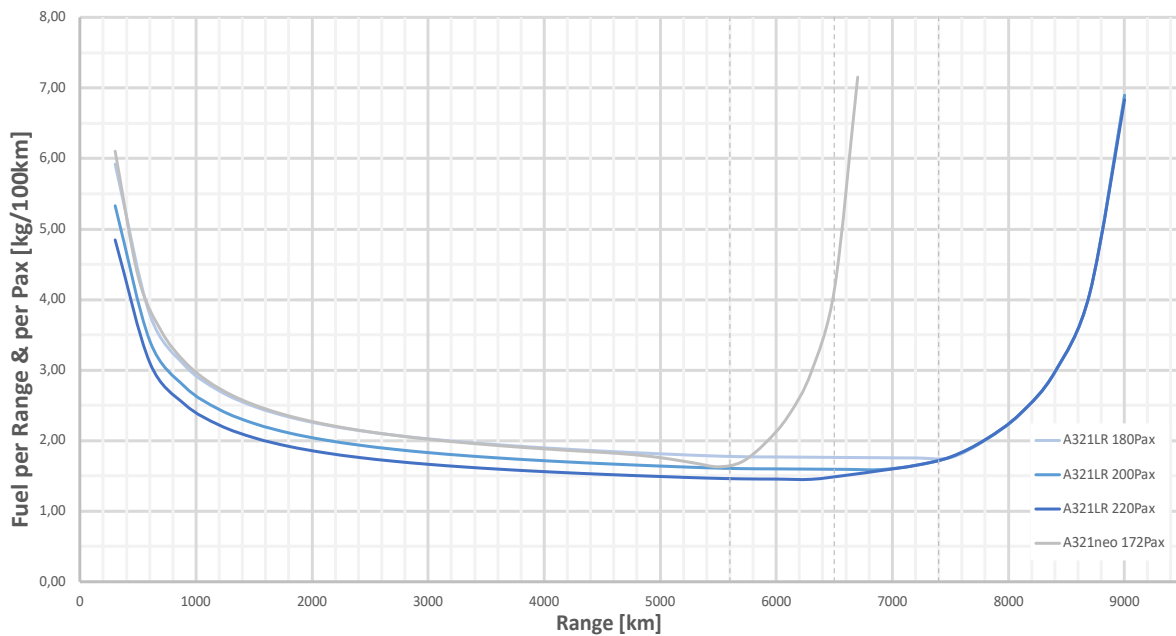
Figure 3.7 shows a direct comparison of the fuel consumption between the A321LR and the XLR for all considered cabin configurations.

With this figure, it becomes even more apparent how similar these two aircraft are. Further, it clarifies in which ranges and/or cabin configurations it is sensible to employ the upcoming XLR instead of the LR. According to its advantages, the XLR enables flying up to an additional 1.000 km without payload reduction, depending on the cabin configuration.



**Figure 3.7** Comparison of fuel consumption per range and passenger over flown distance between the A321LR and the A321XLR – various cabin layouts

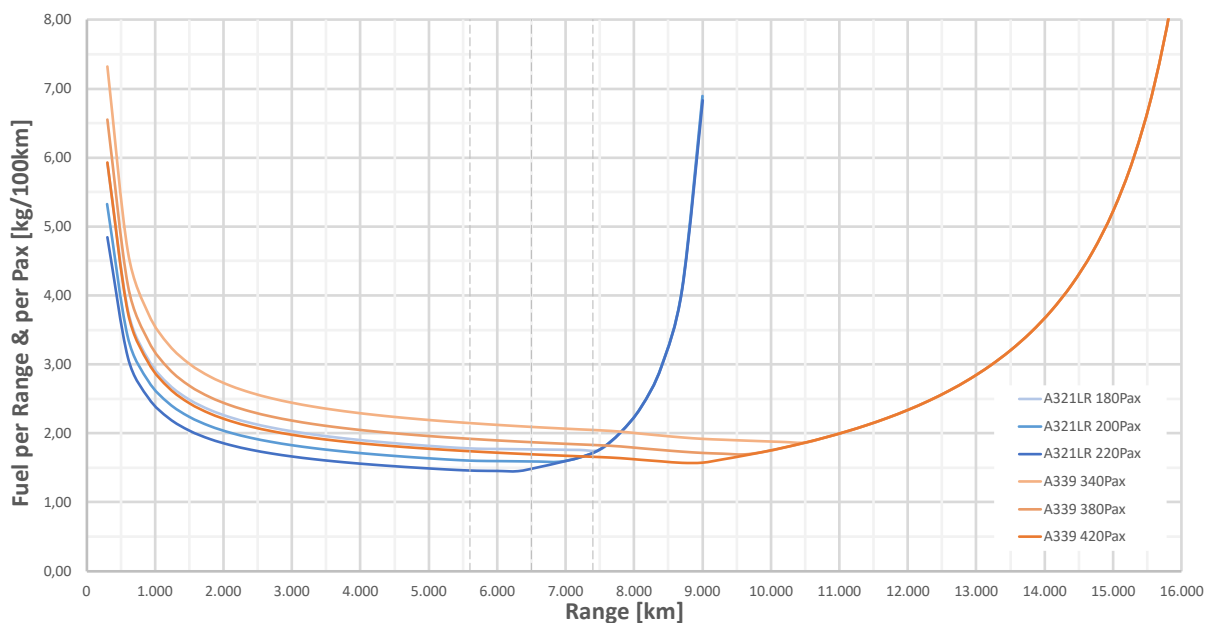
Figure 3.8 shows a direct comparison of the fuel consumption between the A321LR and its immediate predecessor, the A321neo, for all considered cabin configurations.



**Figure 3.8** Comparison of the fuel consumption per range and passenger over flown distance between the A321LR and the A321neo – various cabin layouts

As referred before, a maximum of 172 passengers can be transported with the A321neo for the Mission M1, which is comparable to the low-density cabin configuration of the LR (180 pax). The A321neo only shows lower fuel consumption than the LR up until the range of 5.400 km – around 1,6 kg/100km/pax. After this range, the fuel consumption of the neo increases rapidly, showcasing the design limitations of this aircraft – a significant payload reduction must take place. The LR is capable of flying up to an additional 1.700 km while enabling an even lower fuel consumption (depending on the cabin configuration).

Figure 3.9 shows a direct comparison of the fuel consumption between the A321LR and the A330-900neo for all considered cabin configurations.



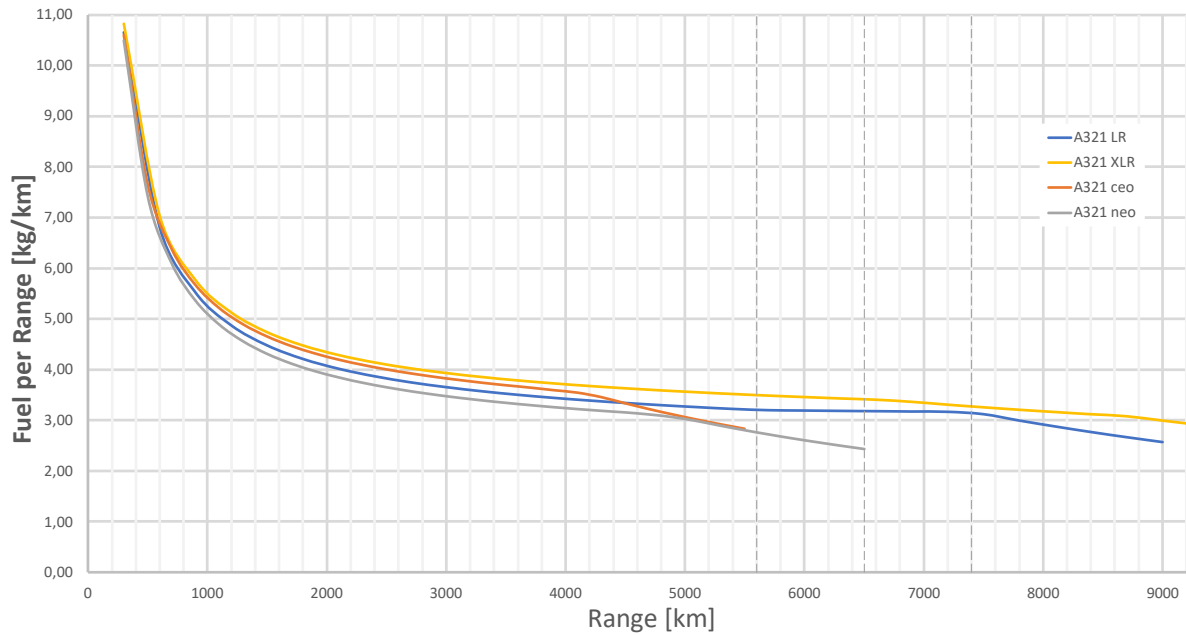
**Figure 3.9** Comparison of fuel consumption per range and passenger over flown distance between the A321LR and the A330-900neo – various cabin layouts

While employing comparable cabin configurations, the fuel consumption of the bigger aircraft does not, in any case, reach lower fuel consumption levels than the A321LR. For example, the lowest fuel consumption for a high-density cabin is 1,45 kg/100km/pax in the A321LR and 1,57 kg/100km/pax in the A339, representing a variation of plus 8.3%. This variation is 6,6% for a standard density cabin and 5,8% for a low-density cabin.

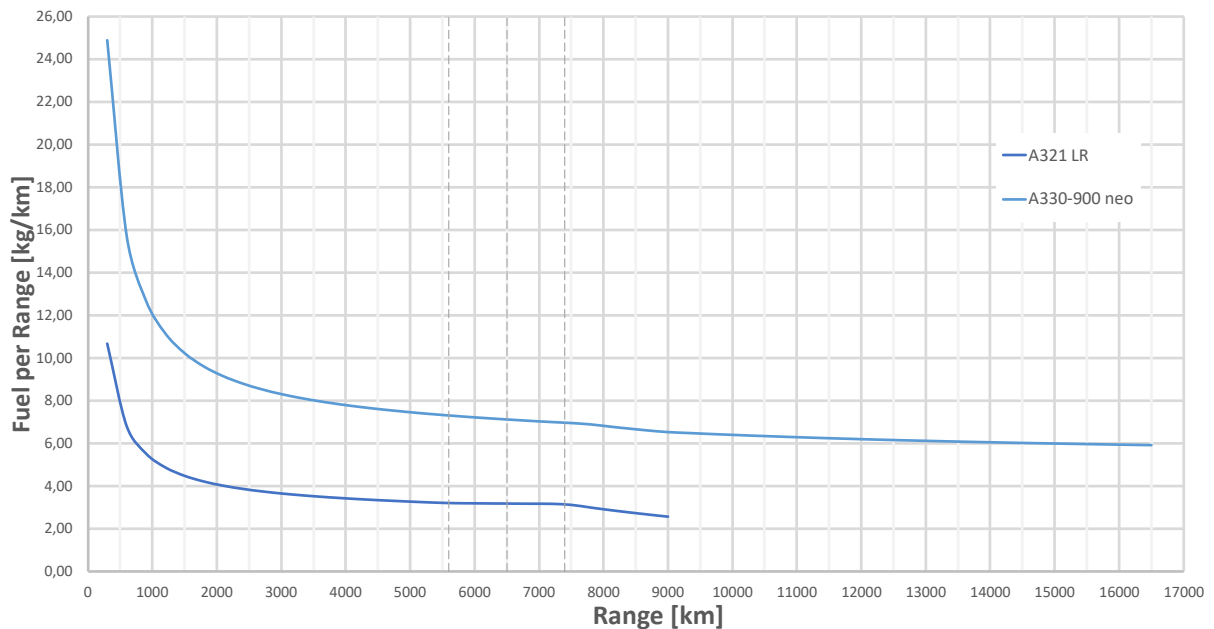
On the other hand, it is evident that the A339 offers range advantages, e.g., in the case of a standard cabin, it can fly up to an additional 2.750 km before having to reduce payload.

## Fuel per Range over Range

Figure 3.10 contains a comparative chart showcasing the resulting fuel consumption per range over the flown distance (kilograms per kilometer) within the A321 family. Figure 3.11 shows a comparison with the A330-900neo.



**Figure 3.10** Comparison of fuel consumption per range over flown distance within the A321 family



**Figure 3.11** Comparison of fuel consumption per range over flown distance between the A321LR and the A330-900neo

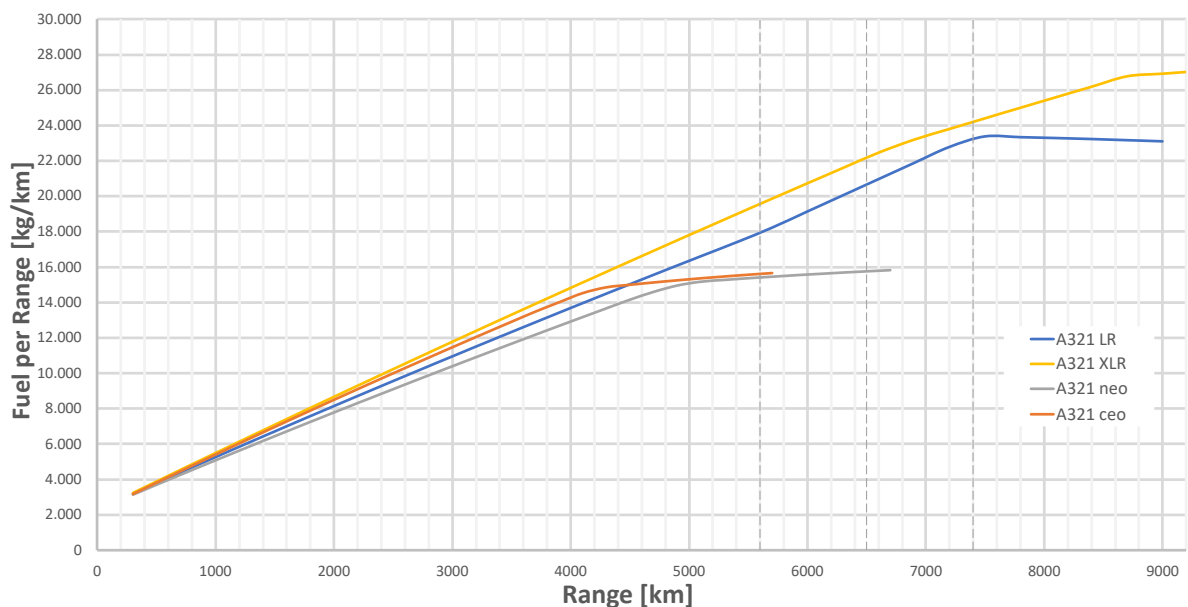
Once again, it is possible to recognize the commonality within the A321 family aircraft, as the curves of each aircraft are very similar to the other ones. The main difference lies in the point at which the curves end, which is lastly determined by the aircraft's (ferry) range. It strikes that, despite having the lowest MTOW, the A321ceo shows higher fuel consumption than the LR and neo, which reinforces the idea of the improved engine efficiency of the newer generation towards the ceo.

In the case of the A330-900neo, this curve is situated at a considerably higher level than the A321LR. For the considered missions, the A321LR consumes a mean of around 57% less fuel per kilometer than the A339.

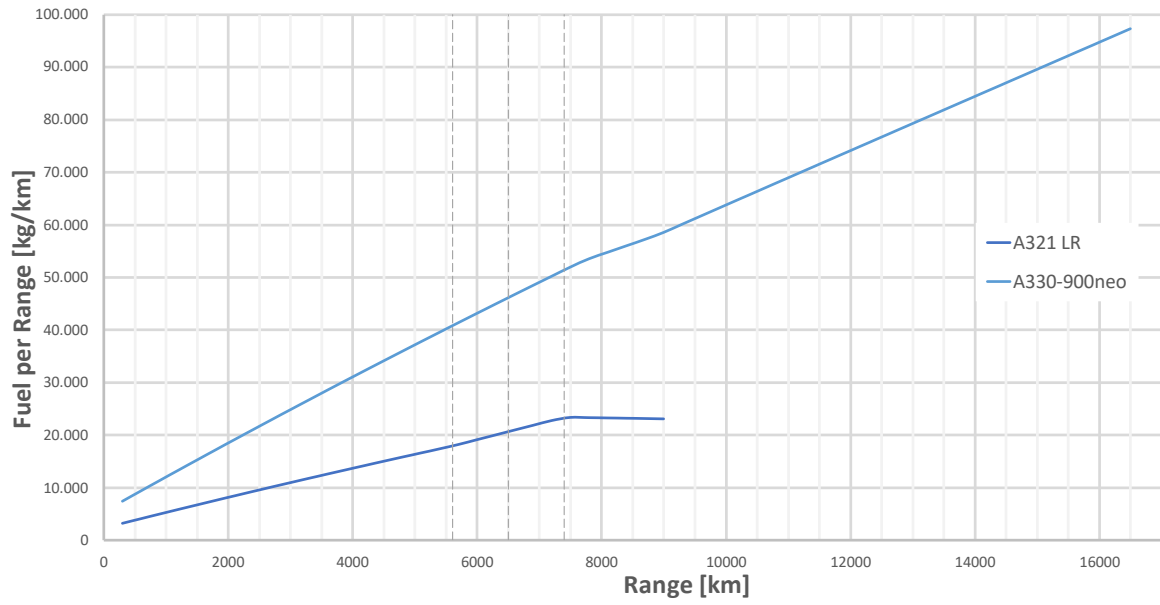
### Fuel over Range

Figure 3.12 contains a comparative chart showcasing the resulting fuel consumption over the flown distance (kilograms per kilometer) within the A321 family. Figure 3.13 shows a comparison with the A330-900neo.

In the same way, the commonality within the A321 family is also recognizable in Figure 3.12. Furthermore, the observation towards the A321ceo is once again valid, as it shows higher relative fuel consumption than the neo versions, with the exception of the XLR, which can be justified by the considerably higher MTOW – the XLR is around 12.000 kg heavier.



**Figure 3.12** Comparison of fuel consumption over the flown distance within the A321 family



**Figure 3.13** Comparison of fuel consumption over the flown distance between the A321LR and the A330-900neo



## 4 Direct Operating Costs of the Airbus A321LR

### 4.1 Introduction

As previously stated, the missions established in Chapter 2.6 were derivated from the Payload-Range Diagram (PRD) of the A321LR and thus represent guidelines to the aircraft's operators. Therefore, the scope of this chapter is to provide a view on the Direct Operating Costs (DOC) of the A321LR while considering the previously mentioned missions.

The two different methods introduced in Chapter 2.3, the TU Berlin method and the AEA method, were used, and the results are presented in the Tables existing in this chapter. In addition, for each Mission, different cabin configurations are considered, and a distinction between flying with (**Index a**) and without additional cargo (**Index b**) is made.

At a given cabin configuration, a corresponding Payload can be calculated by multiplying the number of passengers with the passenger (and luggage) pass  $m_{pass}$ . As appointed in Chapter 2.8, the considered  $m_{pass}$  is **97 kg**.

Furthermore, the calculations without additional cargo imply that the payload and its corresponding trip fuel are situated "inside" the PRD and therefore don't coincide with the delimiting lines of the diagram. Nevertheless, as long as the take-off weight and the landing weight at a given range are known, the correspondent trip fuel can be calculated by employing the Breguet Range equation and therefore using Eqn. (2.11) from Chapter 2.3.

In the same way, if the corresponding trip fuel at a given payload and range is known, a corresponding Breguet Range (BR) can be ascertained using rearrangement of Eqn. (2.30). For example, specific payload-fuel correlations provided by the PRD can be used for a more reliable determination of the Breguet Range. This BR can then be used to calculate other trip fuels at different payloads for the missions without additional cargo.

An exemplary calculation using the first method is shown in Eqn. (4.1), based on Eqn. (2.11). For M2 (6.500 km) the corresponding (maximum) payload and trip fuel were directly extracted from the PRD, and they lastly led to a Breguet Range of 23.168 km.

$$\begin{aligned}
 B &= \frac{R}{\ln\left(\frac{m_1}{m_2}\right)} = B = \frac{R}{\ln\left(\frac{OEW + PL + MFW}{LW}\right)} & (4.1) \\
 &= \frac{6500 \text{ km}}{\ln\left(\frac{52060 + 20795 + 23595}{52060 + 20795}\right) \frac{kg}{kg}} = 23.168 \text{ km}
 \end{aligned}$$

Eqn. (4.2) exemplifies the second method, as the corresponding trip fuel to the referred mission is already known, e.g., throughout an analog mission with additional cargo (read from PRD). This method comes in handy in the case of mission-specific calculations.

$$m_{fuel} = m_2 \left( e^{\frac{R}{B}} - 1 \right) \Leftrightarrow \frac{R}{B} = \ln \left( \frac{m_{fuel}}{m_2} + 1 \right) \Leftrightarrow B = \frac{R}{\ln \left( \frac{m_{fuel}}{m_2} + 1 \right)} \quad (4.2)$$

$$= \frac{6500 \text{ km}}{\ln \left( \frac{23595}{72855} + 1 \right) \frac{kg}{kg}} = 23.168 \text{ km}$$

Furthermore, a comparison of the DOC of the Airbus A321LR with the other considered aircraft is presented in Chapter 4.3, while regarding all the conditions mentioned before.

Each table is accompanied by sensible economic interpretations of the DOC, being the seat-kilometer costs (SKC) or seat-mile-costs (SMC) the ones of major relevance. Besides the SKC, the costs per flight, per trip, per flight hour, and per block hour are given. A summary of the results for all Missions can be retrieved in Appendix H section

## 4.2 Assessment of the DOC

### 4.2.1 M1 – 5600 km

Table 4.1 shows the masses employed in the calculation of the DOC of the Airbus A321LR regarding M1 with, as well as without additional cargo.

**Table 4.1** Payload and trip fuel for the DOC calculation, A321LR – M1 with/without additional cargo

With Additional Cargo							
Cabin Configuration	160 Pax	170 Pax	180 Pax	190 Pax	200 Pax	220 Pax	240 Pax
Mass Payload (Mission) [kg]	23.540	23.540	23.540	23.540	23.540	23.540	23.540
Mass Pax (Mission) [kg]	15.520	16.490	17.460	18.430	19.400	21.340	23.280
Mass Cargo (Mission) [kg]	8.020	7.050	6.080	5.110	4.140	2.200	260
Mass Fuel (Mission) [kg]	21.400	21.400	21.400	21.400	21.400	21.400	21.400
Without Additional Cargo							
Cabin Configuration	160 Pax	170 Pax	180 Pax	190 Pax	200 Pax	220 Pax	240 Pax
Mass Payload (Mission) [kg]	15.520	16.490	17.460	18.430	19.400	21.340	23.540
Mass Pax (Mission) [kg]	15.520	16.490	17.460	18.430	19.400	21.340	23.540
Mass Cargo (Mission) [kg]	0	0	0	0	0	0	0
Mass Fuel (Mission) [kg]	19.130	19.404	19.679	19.953	20.228	20.777	21.400

The additional cargo is added for each cabin configuration in such a way that the maximum allowed payload mass is transported – 23.540 kg (Airbus 2020). By doing this, it is possible to

extract the required (equivalent) trip fuel from the aircraft's PRD. In case of not carrying additional cargo, the trip fuel was calculated with the method described in the previous section, meaning with the help of the Breguet factor.

The bottom part of Table 4.1, containing M1 without additional cargo, shows increasing trip fuel with increasing payload since the **payload varies** and so also the fuel consumption. This observation was expected and can be proven along the PRD. The trip fuel for flights without additional cargo is always lower than the ones with cargo as the fuel consumption is also lower. The most considerable differences occur at the lowest density configurations, where the additional cargo represents a higher percentage of the MPL. For example, a decrease in the trip fuel of ca. 10,6% percent is observed between the 160 pax configuration with and without additional cargo. This difference is only ca. 3% in the case of a 220 pax cabin. The explanation for this behavior is, of course, the fact that the amount (percentage) of extra payload, which can be added, is limited by the maximum payload mass (MPL) for the given mission. In the case of the 160 pax cabin configuration, the added cargo represents 34 % of the maximum payload or 51,7% of the total passenger mass. In the case of the 220 pax cabin, the same values represent 9,3% and 10,3 %, respectively.

The MFW of 23.590 kg is not reached in any case since this mission coincides with the range of at the design point B (range at MPL) of the aircraft – an additional 2.190 kg of fuel are still is possible.

Table 4.2 shows general values used in the computation of the DOC for this Mission (TUB, e.g., 160 pax). The underlined values are established by the DOC method (see Chapter 2.4), whereas the remaining values were taken or were derivated from the aircraft's ACAMP (Airbus 2020).

**Table 4.2** General values for the DOC computation of the A321LR with/without cargo – M1: 160 pax

Aircraft	A321LR - M1		Unit
	w/cargo	no cargo	
Number of PAX	160		-
Range (Mission)	5.600		km
MTOW	97.000		kg
MZFW	75.600		kg
OEW	52.060		kg
Max Payload (Point B)	23.540		kg
Breguet Factor B(B)	-	22.467	km
Landing Weight (B)	-	67.580	kg
Mass Payload (Mission)	23.540	15.520	kg
Mass Pax (Mission)	15.520		kg
Mass Cargo (Mission)	8.020	0	kg
Mass Fuel (Mission)	21.400	19.130	kg
Flight Speed	850		km/h
Flight Time	6,6		h
SLST	145		kN
Engine Weight	3.000		kg
Nr. cabin crew	4		-
Cockpit crew hourly rate	246,5		US\$/h
Cabin crew hourly rate	81		US\$/h
Block Time	1,83		h
CC	5		-

The DOCs calculated with the TUB Method and regarding different cabin configurations are shown in Table 4.3 (with additional cargo) and Table 4.4 (without additional cargo).

**Table 4.3** DOC for the A321LR in M1 for different cabin configurations, with additional cargo – TUB

AIRCRAFT CONFIGURATION		160 PAX	170 PAX	180 PAX	190 PAX	200 PAX	220 PAX	240 PAX
DOC(YEAR)		36,45 M US\$	36,45 M US\$	36,45 M US\$	36,45 M US\$	36,45 M US\$	36,82 M US\$	36,82 M US\$
CCAPITAL		8,37 M US\$	8,37 M US\$	8,37 M US\$	8,37 M US\$	8,37 M US\$	8,37 M US\$	8,37 M US\$
CCREW		3,29 M US\$	3,29 M US\$	3,29 M US\$	3,29 M US\$	3,29 M US\$	3,66 M US\$	3,66 M US\$
CMaintenance		2,25 M US\$	2,25 M US\$	2,25 M US\$	2,25 M US\$	2,25 M US\$	2,25 M US\$	2,25 M US\$
CFuel		14,89 M US\$	14,89 M US\$	14,89 M US\$	14,89 M US\$	14,89 M US\$	14,89 M US\$	14,89 M US\$
CHANDLING		2,05 M US\$	2,05 M US\$	2,05 M US\$	2,05 M US\$	2,05 M US\$	2,05 M US\$	2,05 M US\$
CLANDING		0,84 M US\$	0,84 M US\$	0,84 M US\$	0,84 M US\$	0,84 M US\$	0,84 M US\$	0,84 M US\$
CATC		4,75 M US\$	4,75 M US\$	4,75 M US\$	4,75 M US\$	4,75 M US\$	4,75 M US\$	4,75 M US\$
Economical DOC Interpretation								
Aircraft trip costs	Ca/c,t	\$51.122,21	\$51.122,21	\$51.122,21	\$51.122,21	\$51.122,21	\$51.635,53	\$51.635,53
Aircraft mile costs	Ca/c,m	\$16,91	\$16,91	\$16,91	\$16,91	\$16,91	\$17,08	\$17,08
Aircraft kilometer costs	Ca/c,km	\$9,13	\$9,13	\$9,13	\$9,13	\$9,13	\$9,22	\$9,22
Seat-mile costs	Cs,m	\$0,106	\$0,099	\$0,094	\$0,089	\$0,085	\$0,078	\$0,071
Seat-kilometer costs	Cs,km	\$0,057	\$0,054	\$0,051	\$0,048	\$0,046	\$0,042	\$0,038
Costs per flight hour	Ca/c,f	\$7.745,79	\$7.745,79	\$7.745,79	\$7.745,79	\$7.745,79	\$7.823,57	\$7.823,57
Costs per block hour	Ca/c,b	\$6.064,32	\$6.064,32	\$6.064,32	\$6.064,32	\$6.064,32	\$6.125,21	\$6.125,21

**Table 4.4** DOC for the A321LR in M1 for different cabin configurations, without additional cargo – TUB

Aircraft Configuration		160 PAX	170 PAX	180 PAX	190 PAX	200 PAX	220 PAX	240 PAX
DOC(Year)		34,17 M US\$	34,45 M US\$	34,72 M US\$	35,00 M US\$	35,27 M US\$	36,19 M US\$	36,82 M US\$
CCAPITAL		8,37 M US\$	8,37 M US\$	8,37 M US\$	8,37 M US\$	8,37 M US\$	8,37 M US\$	8,37 M US\$
CCREW		3,29 M US\$	3,29 M US\$	3,29 M US\$	3,29 M US\$	3,29 M US\$	3,66 M US\$	3,66 M US\$
CMaintenance		2,25 M US\$	2,25 M US\$	2,25 M US\$	2,25 M US\$	2,25 M US\$	2,25 M US\$	2,25 M US\$
CFuel		13,31 M US\$	13,50 M US\$	13,69 M US\$	13,89 M US\$	14,08 M US\$	14,46 M US\$	14,89 M US\$
CHANDLING		1,35 M US\$	1,43 M US\$	1,52 M US\$	1,60 M US\$	1,69 M US\$	1,86 M US\$	2,05 M US\$
CLANDING		0,84 M US\$	0,84 M US\$	0,84 M US\$	0,84 M US\$	0,84 M US\$	0,84 M US\$	0,84 M US\$
CATC		4,75 M US\$	4,75 M US\$	4,75 M US\$	4,75 M US\$	4,75 M US\$	4,75 M US\$	4,75 M US\$
Economical DOC Interpretation								
Aircraft trip costs	Ca/c,t	\$47.928,02	\$48.314,35	\$48.700,68	\$49.087,00	\$49.473,33	\$50.759,31	\$51.635,51
Aircraft mile costs	Ca/c,m	\$15,85	\$15,98	\$16,11	\$16,23	\$16,36	\$16,79	\$17,08
Aircraft kilometer costs	Ca/c,km	\$8,56	\$8,63	\$8,70	\$8,77	\$8,83	\$9,06	\$9,22
Seat-mile costs	Cs,m	\$0,099	\$0,094	\$0,089	\$0,085	\$0,082	\$0,076	\$0,070
Seat-kilometer costs	Cs,km	\$0,053	\$0,051	\$0,048	\$0,046	\$0,044	\$0,041	\$0,038
Costs per flight hour	Ca/c,f	\$7.261,82	\$7.320,36	\$7.378,89	\$7.437,42	\$7.495,96	\$7.690,80	\$7.823,56
Costs per block hour	Ca/c,b	\$5.685,41	\$5.731,24	\$5.777,07	\$5.822,89	\$5.868,72	\$6.021,27	\$6.125,21

It strikes that Table 4.3 shows less variation than Table 4.4. Because the payload is the same, the only observed variation along Table 4.3 is in the case of an added cabin crew member – in compliance with the rule of one cabin crew per each 50 pax. According to this method, the DOCs for M1 with additional cargo are 36,45 M US\$ or 36,82 M US\$ per year depending on the cabin crew number being four or five. This translates into aircraft-kilometer costs (AKC) of 9,13 US\$ or 9,22 US\$. The seat-kilometer costs range from 0,057 US\$ to 0,038 US\$ from lowest to highest cabin density, representing a variation of 0,019 US\$ or -33,3 %.

The highest stake of the DOC is taken by the fuel costs ( $C_{Fuel}$ ), which represent slightly over 40% of the total costs. The lowest stake is taken by the landing costs per year, which totalize ca. 2,3% of the DOC.

In Table 4.4, not only the crew costs but also the fuel and the handling costs vary, as they are mission dependent (see Chapter 2.4). Consequently, a general increase of the DOC with increasing cabin seating configuration can be observed. Given the fact that no additional cargo is carried, which causes more fuel consumption, the DOCs in Table 4.4 are always lower than the correspondent ones in Table 4.3. Here, the yearly DOCs vary from 34,37 M US\$ to 36,82 M US\$ per year (+6,65% variation) with a step-change of around 0,27M US\$ per 10 pax while keeping the same amount of cabin crew. This translates into aircraft-kilometer costs (AKC), which range from 8,56 US\$ to 9,22 US\$. The seat-kilometer cost ranges from 0,053 US\$ to 0,038 US\$ from lowest to highest cabin density, representing a variation of 0,015 US\$ or -27,8%. The costs per flight hour are appointed to be at least 7.746 US\$ for M1a and at least 7.262 US\$ for M1b at the lowest cabin configuration.

Following, the DOC calculated with the AEA Method regarding different cabin configurations are shown in Table 4.5 (with additional cargo) and Table 4.6 (without additional cargo).

**Table 4.5** DOC for the A321LR in M1 for different cabin configurations, with additional cargo – AEA

Aircraft Configuration		160 PAX	170 PAX	180 PAX	190 PAX	200 PAX	220 PAX	240 PAX
DOC(YEAR)		66,39 M US\$	66,39 M US\$	66,39 M US\$	66,39 M US\$	66,47 M US\$	66,68 M US\$	66,68 M US\$
CDEPRECIATION		9,66 M US\$	9,66 M US\$	9,66 M US\$	9,66 M US\$	9,66 M US\$	9,66 M US\$	9,66 M US\$
CINTEREST		7,95 M US\$	7,95 M US\$	7,95 M US\$	7,95 M US\$	7,95 M US\$	7,95 M US\$	7,95 M US\$
CINSURANCE		0,68 M US\$	0,68 M US\$	0,68 M US\$	0,68 M US\$	0,68 M US\$	0,68 M US\$	0,68 M US\$
CFUEL		10,71 M US\$	10,71 M US\$	10,71 M US\$	10,71 M US\$	10,71 M US\$	10,71 M US\$	10,71 M US\$
CMAINTEANCE		7,56 M US\$	7,56 M US\$	7,56 M US\$	7,56 M US\$	7,63 M US\$	7,56 M US\$	7,56 M US\$
CCREW		2,86 M US\$	2,86 M US\$	2,86 M US\$	2,86 M US\$	2,86 M US\$	3,14 M US\$	3,14 M US\$
CFEES		26,98 M US\$	26,98 M US\$	26,98 M US\$	26,98 M US\$	26,99 M US\$	26,98 M US\$	26,98 M US\$
Economical DOC Interpretation								
Aircraft trip costs	Ca/c,t	\$129.421,58	\$129.421,58	\$129.421,58	\$129.421,58	\$129.579,92	\$129.973,48	\$129.973,48
Aircraft mile costs	Ca/c,m	\$42,80	\$42,80	\$42,80	\$42,80	\$42,85	\$42,98	\$42,98
Aircraft kilometer costs	Ca/c,km	\$23,11	\$23,11	\$23,11	\$23,11	\$23,14	\$23,21	\$23,21
Seat-mile costs	Cs,m	\$0,268	\$0,252	\$0,238	\$0,225	\$0,214	\$0,195	\$0,179
Seat-kilometer costs	Cs,km	\$0,144	\$0,136	\$0,128	\$0,122	\$0,116	\$0,105	\$0,097
Costs per flight hour	Ca/c,f	\$19.718,30	\$19.718,30	\$19.718,30	\$19.718,30	\$19.742,43	\$19.802,39	\$19.075,80
Costs per block hour	Ca/c,b	\$18.994,80	\$18.994,80	\$18.994,80	\$18.994,80	\$19.018,04	\$19.075,80	\$19.090,68

**Table 4.6** DOC for the A321LR in M1 for different cabin configurations, without additional cargo – AEA

Aircraft Configuration		160 PAX	170 PAX	180 PAX	190 PAX	200 PAX	220 PAX	240 PAX
DOC(Year)		62,17	62,68	63,19	63,70	64,21	65,52	66,76
CDEPRECIATION		9,66	9,66	9,66	9,66	9,66	9,66	9,66
CINTEREST		7,95	7,95	7,95	7,95	7,95	7,95	7,95
CINSURANCE		0,68	0,68	0,68	0,68	0,68	0,68	0,68
CFUEL		9,58	9,72	9,85	9,99	10,13	10,40	10,83
CMAINTEANCE		7,56	7,56	7,56	7,56	7,56	7,56	7,63
CCREW		2,86	2,86	2,86	2,86	2,86	3,14	3,14
CFEES		23,89	24,26	24,64	25,01	25,38	26,13	26,88
Economical DOC Interpretation								
Aircraft trip costs	Ca/c,t	121.189	122.185	123.180	124.176	125.172	127.715	130.139
Aircraft mile costs	Ca/c,m	40,08	40,41	40,74	41,07	41,40	42,24	43,04
Aircraft kilometer costs	Ca/c,km	21,64	21,82	22,00	22,17	22,35	22,81	23,24
Seat-mile costs	Cs,m	0,250	0,238	0,226	0,216	0,207	0,192	0,179
Seat-kilometer costs	Cs,km	0,135	0,128	0,122	0,117	0,112	0,104	0,097
Costs per flight hour	Ca/c,f	18.464	18.616	18.767	18.919	19.071	19.458	19.828
Costs per block hour	Ca/c,b	17.787	17.933	18.079	18.225	18.371	18.744	19.100

It strikes that the DOCs are higher than the ones calculated with the TUB Berlin method, by at least 80%. This is mostly because this method assumes a considerably larger stake for the fees inherent to the aircraft's operations. These costs represent around 40% of the yearly DOCs, whereas they only represent around 21% in the TUB method considering the  $C_{ATC}$ ,  $C_{LANDING}$ , and  $C_{HANDLING}$  together. Also, the maintenance costs are at least three times higher than in the TUB method. On the other hand, the  $C_{FUEL}$  and  $C_{CREW}$  are relatively lower, by at least -28% and -15,6%, respectively.

In Table 4.5, similarly to Table 4.3, the only variation is when an extra cabin crew member is added. According to the AEA method, the DOCs for M1 with additional cargo are 66,39 M US\$ or 66,68 M US\$ per year depending on the cabin crew number being four or five. The aircraft-kilometer costs are then 23,11 US\$ or 23,21 US\$. The seat-kilometer costs range from

0,144 US\$ to 0,097 US\$ from lowest to highest cabin density, representing a variation of 0,047 US\$ or 32,5%.

Again, in Table 4.6, not only the crew costs but also the  $C_{FUEL}$  and the  $C_{FEES}$  vary. As seen before, the  $C_{FUEL}$  are always lower if no extra cargo is added. A general increase of the DOCs with increasing cabin configuration is once more observed. The DOCs vary here from 62,17 M US\$ to 66,76 M US\$ per year (7,4% variation) with a step-change of around 0,51M US\$ and 0,62 M US\$ per 10 pax while keeping the same number of cabin crew. The AKCs vary from 21,64 US\$ to 23,24 US\$ and the SKCs range from 0,135 US\$ to 0,097 US\$ from lowest to highest cabin density, representing a variation of 0,38 US\$ or 28,1%.

### 4.2.2 M2 – 6500 km

Table 4.7 shows the masses employed in the calculation of the DOCs of the Airbus A321LR regarding M2 with, as well as without additional cargo. The additional cargo is again added for each cabin configuration in such a way that the now maximum **possible** payload mass of 20.795 kg is transported (Airbus 2020) – 2.745 kg lower than in M1 (-11,6%). By doing this, it is possible to extract the required (equivalent) trip fuel from the aircraft's PRD by means of interpolation.

In case of not carrying additional cargo, the trip fuel was calculated as mentioned before.

**Table 4.7** Payload and trip fuel for the DOC calculation, A321LR – M2, with/without additional cargo

With Additional Cargo						
Cabin Configuration	160 PAX	170 PAX	180 PAX	190 PAX	200 PAX	214 PAX
Mass Payload (Mission) [kg]	20.795	20.795	20.795	20.795	20.795	20.795
Mass Pax (Mission) [kg]	15.520	16.490	17.460	18.430	19.400	20.758
Mass Cargo (Mission) [kg]	5.275	4.305	3.335	2.365	1.395	37
Mass Fuel (Mission) [kg]	23.595	23.595	23.595	23.595	23.595	23.595
Without Additional Cargo						
Cabin Configuration	160 PAX	170 PAX	180 PAX	190 PAX	200 PAX	214 PAX
Mass Payload (Mission) [kg]	15.520	16.490	17.460	18.430	19.400	20.758
Mass Pax (Mission) [kg]	15.520	16.490	17.460	18.430	19.400	20.758
Mass Cargo (Mission) [kg]	0	0	0	0	0	0
Mass Fuel (Mission) [kg]	21.887	22.201	22.515	22.829	23.143	23.583

The same observations stated in Section 4.2.1 apply to this table as well. A notorious difference is the fact that the added cargo here represents a generally lower percentage of the maximum payload for the Mission in comparison to M1. In this case, the MFW of 23.590 kg limits the payload of the mission. Therefore, the maximum corresponding passengers which can be carried (à 97 kg) is **214**.

Table 4.8 shows general values used in the computation of the DOCs for mission M2 (TUB, e.g., 160 pax).





**Table 4.10** DOC for the A321LR in M2 for different cabin configurations, without additional cargo – TUB

AIRCRAFT CONFIGURATION		160 PAX	170 PAX	180 PAX	190 PAX	200 PAX	220 PAX
DOC(YEAR)		34,36 M US\$	34,63 M US\$	34,90 M US\$	35,17 M US\$	35,44 M US\$	36,19 M US\$
CCAPITAL		8,37 M US\$	8,37 M US\$	8,37 M US\$	8,37 M US\$	8,37 M US\$	8,37 M US\$
CCREW		3,29 M US\$	3,29 M US\$	3,29 M US\$	3,29 M US\$	3,29 M US\$	3,66 M US\$
CMaintenance		2,21 M US\$	2,21 M US\$	2,21 M US\$	2,21 M US\$	2,21 M US\$	2,21 M US\$
CFUEL		13,61 M US\$	13,80 M US\$	14,00 M US\$	14,19 M US\$	14,39 M US\$	14,66 M US\$
CHANDLING		1,21 M US\$	1,28 M US\$	1,36 M US\$	1,43 M US\$	1,51 M US\$	1,61 M US\$
CLANDING		0,75 M US\$	0,75 M US\$	0,75 M US\$	0,75 M US\$	0,75 M US\$	0,75 M US\$
CATC		4,93 M US\$	4,93 M US\$	4,93 M US\$	4,93 M US\$	4,93 M US\$	4,93 M US\$
Economical DOC Interpretation							
Aircraft trip costs	Ca/c,t	\$53.943,78	\$54.368,73	\$54.793,68	\$55.218,62	\$55.643,57	\$56.813,07
Aircraft mile costs	Ca/c,m	\$15,37	\$15,49	\$15,61	\$15,73	\$15,85	\$16,19
Aircraft kilometer costs	Ca/c,km	\$8,30	\$8,36	\$8,43	\$8,50	\$8,56	\$8,74
Seat-mile costs	Cs,m	\$0,096	\$0,091	\$0,087	\$0,083	\$0,079	\$0,076
Seat-kilometer costs	Cs,km	\$0,052	\$0,049	\$0,047	\$0,045	\$0,043	\$0,041
Costs per flight hour	Ca/c,f	\$7.097,87	\$7.153,78	\$7.209,69	\$7.265,61	\$7.321,52	\$7.475,40
Costs per block hour	Ca/c,b	\$5.720,44	\$5.765,51	\$5.810,57	\$5.855,63	\$5.900,70	\$6.024,72

The calculated DOCs are minimally **lower** than the ones of M1 – around -1,7%. The only costs, which are higher in M2 in comparison to M1, are the air traffic control costs ( $C_{ATC}$ ), which are mission dependent and therefore directly proportional to the range of the mission. The other mission-dependent costs, being  $C_{FUEL}$ ,  $C_{HANDLING}$ ,  $C_{LANDING}$ , and  $C_{MAINTENANCE}$ , are all lower because they also depend on the number of flight-cycles (**FC**) besides the range. The larger range of M2 implies a **reduced** amount of maximum allowed flights per year in compliance with the concepts shown in Section 2.4.3 (M1: 713 vs. M2: 637). This correlation contributes in this case to a reduction of the referred costs in comparison to M1, as the costs are at the end multiplied by the number of FC per year.

On the other hand, a singular aircraft trip costs more (at least 10 %) than in M1, varying from 56.254 US\$ to 56.829 US\$ with additional cargo and from 53.943 US\$ to 56.813 US\$ without additional cargo, exactly because of the reduced FC – fewer flights to distribute the costs. The SKCs are slightly lower than the ones from M1.

The DOCs calculated with the AEA Method and regarding different cabin configurations are shown in Table 4.11 (with additional cargo) and Table 4.12 (without additional cargo).

As learned before, the DOCs with the AEA method are higher than the ones calculated with the TUB Berlin method. In comparison to M1, the total costs per year are, once more, lower in M2 – at least 2% in the lowest density cabin. Furthermore, the difference between the DOCs with and without additional cargo is also smaller at a given cabin configuration.

According to this method, the yearly DOCs for M2 range from 63,71 M US\$ to 64,00 M US\$ with additional cargo and 61,26 M US\$ to 64,04 M US\$ without additional cargo (lower than M1). The aircraft-kilometer-costs range from 142.211 US\$ to 142.848 US\$ with additional cargo and from 136.751 US\$ to 142.948 US\$ without additional cargo (at least 10 % higher

than in M1). Lastly, the seat-kilometer costs vary with additional cargo from 0,137 US\$ to 0,103 US\$ and from 0,131 US\$ to 0,103 US\$ without additional cargo, from lowest to highest cabin density (lower than M1).

**Table 4.11** DOC for the A321LR in M2 for different cabin configurations, with additional cargo – AEA

Aircraft Configuration		160 PAX	170 PAX	180 PAX	190 PAX	200 PAX	214 PAX
DOC(YEAR)		63,71	63,71	63,71	63,71	63,71	64,00
CDEPRECIATION		9,66 M US\$	9,66 M US\$	9,66 M US\$	9,66 M US\$	9,66 M US\$	9,66 M US\$
CINTEREST		7,95 M US\$	7,95 M US\$	7,95 M US\$	7,95 M US\$	7,95 M US\$	7,95 M US\$
CINSURANCE		0,68 M US\$	0,68 M US\$	0,68 M US\$	0,68 M US\$	0,68 M US\$	0,68 M US\$
CFUEL		10,32 M US\$	10,32 M US\$	10,32 M US\$	10,32 M US\$	10,32 M US\$	10,32 M US\$
CMAINTEANCE		7,49 M US\$	7,49 M US\$	7,49 M US\$	7,49 M US\$	7,49 M US\$	7,49 M US\$
CCREW		2,88 M US\$	2,88 M US\$	2,88 M US\$	2,88 M US\$	2,88 M US\$	3,17 M US\$
CFEES		24,74 M US\$	24,74 M US\$	24,74 M US\$	24,74 M US\$	24,74 M US\$	24,74 M US\$
Economical DOC Interpretation							
Aircraft trip costs	Ca/c,t	\$142.210,63	\$142.210,63	\$142.210,63	\$142.210,63	\$142.210,63	\$142.847,97
Aircraft mile costs	Ca/c,m	\$40,52	\$40,52	\$40,52	\$40,52	\$40,52	\$40,70
Aircraft kilometer costs	Ca/c,km	\$21,88	\$21,88	\$21,88	\$21,88	\$21,88	\$21,98
Seat-mile costs	Cs,m	\$0,253	\$0,238	\$0,225	\$0,213	\$0,203	\$0,190
Seat-kilometer costs	Cs,km	\$0,137	\$0,129	\$0,122	\$0,115	\$0,109	\$0,103
Costs per flight hour	Ca/c,f	\$18.666,79	\$18.666,79	\$18.666,79	\$18.666,79	\$18.666,79	\$18.750,44
Costs per block hour	Ca/c,b	\$18.073,69	\$18.073,69	\$18.073,69	\$18.073,69	\$18.073,69	\$18.154,69

**Table 4.12** DOC for the A321LR in M2 for different cabin configurations, without additional cargo – AEA

Aircraft Configuration		160 PAX	170 PAX	180 PAX	190 PAX	200 PAX	214 PAX
DOC(YEAR)		61,26 M US\$	61,73 M US\$	62,19 M US\$	62,65 M US\$	63,11 M US\$	64,04 M US\$
CDEPRECIATION		9,66 M US\$	9,66 M US\$	9,66 M US\$	9,66 M US\$	9,66 M US\$	9,66 M US\$
CINTEREST		7,95 M US\$	7,95 M US\$	7,95 M US\$	7,95 M US\$	7,95 M US\$	7,95 M US\$
CINSURANCE		0,68 M US\$	0,68 M US\$	0,68 M US\$	0,68 M US\$	0,68 M US\$	0,68 M US\$
CFUEL		9,58 M US\$	9,71 M US\$	9,85 M US\$	9,98 M US\$	10,12 M US\$	10,31 M US\$
CMAINTEANCE		7,55 M US\$	7,55 M US\$	7,55 M US\$	7,55 M US\$	7,55 M US\$	7,55 M US\$
CCREW		2,88 M US\$	2,88 M US\$	2,88 M US\$	2,88 M US\$	2,88 M US\$	3,17 M US\$
CFEES		22,97 M US\$	23,29 M US\$	23,62 M US\$	23,95 M US\$	24,27 M US\$	24,73 M US\$
Economical DOC Interpretation							
Aircraft trip costs	Ca/c,t	\$136.750,69	\$137.780,37	\$138.810,05	\$139.839,72	\$140.869,40	\$142.948,29
Aircraft mile costs	Ca/c,m	\$38,96	\$39,26	\$39,55	\$39,84	\$40,14	\$40,73
Aircraft kilometer costs	Ca/c,km	\$21,04	\$21,20	\$21,36	\$21,51	\$21,67	\$21,99
Seat-mile costs	Cs,m	\$0,244	\$0,231	\$0,220	\$0,210	\$0,201	\$0,190
Seat-kilometer costs	Cs,km	\$0,131	\$0,125	\$0,119	\$0,113	\$0,108	\$0,103
Costs per flight hour	Ca/c,f	\$17.950,11	\$18.085,26	\$18.220,42	\$18.355,58	\$18.490,73	\$18.763,61
Costs per block hour	Ca/c,b	\$17.379,78	\$17.510,64	\$17.641,51	\$17.772,37	\$17.903,23	\$18.167,44

### 4.2.3 M3 – 7400 km

Table 4.13 shows the masses employed in the calculation of the DOCs for the Airbus A321LR regarding M3 with, as well as without additional cargo. The additional cargo is again added in such a way that the maximum **possible** payload is transported – 18.050 kg (Airbus 2020). By doing this, it is possible to extract the required (equivalent) trip fuel from the aircraft's PRD.

Once more, for the cases without additional cargo, the trip fuel was calculated with the methods previously mentioned.

**Table 4.13** Payload and trip fuel for the DOC calculation, A321LR – M1, with/without additional cargo

With Additional Cargo				
Cabin Configuration	160 Pax	170 Pax	180 Pax	186 PAX
Mass Payload (Mission) [kg]	18.050	18.050	18.050	18.050
Mass Pax (Mission) [kg]	15.520	16.490	17.460	18.042
Mass Cargo (Mission) [kg]	2.530	1.560	590	8
Mass Fuel (Mission) [kg]	25.790	25.790	25.790	25.790
Without Additional Cargo				
Cabin Configuration	160 Pax	170 Pax	180 Pax	186 PAX
Mass Payload (Mission) [kg]	15.520	16.490	17.460	18.042
Mass Pax (Mission) [kg]	15.520	16.490	17.460	18.042
Mass Cargo (Mission) [kg]	0	0	0	0
Mass Fuel (Mission) [kg]	24.860	25.216	25.573	25.787

The same observations stated in Sections 4.2.1 and 4.2.2 apply here as well, with the added cargo representing an even smaller percentage of the maximum payload. As a consequence, the added fuel due to additional cargo is relatively small. Furthermore, this mission is heavily limited by the MFW. The maximum payload that can be carried represents around 75% of the MPL. This translates into a maximum of **186 pax** à 97 kg.

Table 4.14 shows general values used in the computation of the DOCs for this Mission (TUB, e.g., 160 pax).

**Table 4.14** General values for the DOC computation, A321LR – M3, with/without additional cargo: 160 pax

Aircraft	A321 LR - M3		Unit
	w/cargo	no cargo	
Number of PAX	160		-
Range (Mission)	7.400		km
MTOW	97.000		kg
MZFW	75.600		kg
OEW	52.060		kg
Max Payload (Point B)	23.540		kg
Mass Payload (max. : C)	18.050		kg
Range (B)	5.600		km
Range (C)	7.400		km
Mass Fuel B	21.400		kg
MFW	25.790		kg
Breguet Factor B(B)	-	22.467	km
Breguet Factor B(C)	-	23.942	km
Breguet Factor B(R)	-	23.942	km
Landing Weight (B)	-	68.680	kg
Mass Payload (Mission)	18.050	15.520	kg
Mass Pax (Mission)	15.520		kg
Mass Cargo (Mission)	2.530	0	kg
Mass Fuel (Mission)	25.790	24.860	kg
Flight Speed	850		km/h
Flight Time	8,7		h
SLST	145,16		kN
Engine Weight	3.000		kg
Nr. cabin crew	4		-
Cockpit crew hourly rate	246,5		US\$/h
Cabin crew hourly rate	81,0		US\$/h
Block Time	1,83		h
CC	5		-

The DOCs calculated with the TUB Method and regarding different cabin configurations are shown in Table 4.15 (with additional cargo) and Table 4.16 (without additional cargo).

**Table 4.15** DOC for the A321LR in M3 for different cabin configurations, with additional cargo – TUB

AIRCRAFT CONFIGURATION		160 PAX	170 PAX	180 PAX	186 PAX
DOC(YEAR)		35,12 M US\$	35,12 M US\$	35,12 M US\$	35,12 M US\$
CCAPITAL		8,37 M US\$	8,37 M US\$	8,37 M US\$	8,37 M US\$
CCREW		3,29 M US\$	3,29 M US\$	3,29 M US\$	3,29 M US\$
CMaintenance		2,17 M US\$	2,17 M US\$	2,17 M US\$	2,17 M US\$
CFuel		14,35 M US\$	14,35 M US\$	14,35 M US\$	14,35 M US\$
CHANDLING		1,26 M US\$	1,26 M US\$	1,26 M US\$	1,26 M US\$
CLANDING		0,67 M US\$	0,67 M US\$	0,67 M US\$	0,67 M US\$
CATC		5,02 M US\$	5,02 M US\$	5,02 M US\$	5,02 M US\$
Economical DOC Interpretation					
Aircraft trip costs	Ca/ct	\$61.617,78	\$61.617,78	\$61.617,78	\$61.617,78
Aircraft mile costs	Ca/cm	\$15,42	\$15,42	\$15,42	\$15,42
Aircraft kilometer costs	Ca/c,km	\$8,33	\$8,33	\$8,33	\$8,33
Seat-mile costs	Cs,m	\$0,096	\$0,091	\$0,086	\$0,083
Seat-kilometer costs	Cs,km	\$0,052	\$0,049	\$0,046	\$0,045
Costs per flight hour	Ca/c,f	\$7.082,50	\$7.082,50	\$7.082,50	\$7.082,50
Costs per block hour	Ca/c,b	\$5.851,64	\$5.851,64	\$5.851,64	\$5.851,64

**Table 4.16** DOC for the A321LR in M3 for different cabin configurations, without additional cargo – TUB

AIRCRAFT CONFIGURATION		160 PAX	170 PAX	180 PAX	186 PAX
DOC(YEAR)		34,43 M US\$	34,69 M US\$	34,96 M US\$	35,12 M US\$
CCAPITAL		8,37 M US\$	8,37 M US\$	8,37 M US\$	8,37 M US\$
CCREW		3,29 M US\$	3,29 M US\$	3,29 M US\$	3,29 M US\$
CMAINTENANCE		2,17 M US\$	2,17 M US\$	2,17 M US\$	2,17 M US\$
CFUEL		13,83 M US\$	14,03 M US\$	14,23 M US\$	14,35 M US\$
CHANDLING		1,08 M US\$	1,15 M US\$	1,21 M US\$	1,25 M US\$
CLANDING		0,67 M US\$	0,67 M US\$	0,67 M US\$	0,67 M US\$
CATC		5,02 M US\$	5,02 M US\$	5,02 M US\$	5,02 M US\$
Economical DOC Interpretation					
Aircraft trip costs	Ca/c,t	\$60.401,09	\$60.867,68	\$61.334,28	\$61.614,24
Aircraft mile costs	Ca/c,m	\$15,12	\$15,23	\$15,35	\$15,42
Aircraft kilometer costs	Ca/c,km	\$8,16	\$8,23	\$8,29	\$8,33
Seat-mile costs	Cs,m	\$0,094	\$0,090	\$0,085	\$0,083
Seat-kilometer costs	Cs,km	\$0,051	\$0,048	\$0,046	\$0,045
Costs per flight hour	Ca/c,f	\$6.942,65	\$6.996,29	\$7.049,92	\$7.082,10
Costs per block hour	Ca/c,b	\$5.736,10	\$5.780,41	\$5.824,72	\$5.851,30

The tables show that the M3 has the lowest annual direct operating costs for missions with additional cargo but has the highest DOCs if no extra cargo is carried on board. The influence of the annual flight-cycles is very visible (here 570), as it increases the aircraft-trip costs by around 10.000 US\$ per flight in comparison to M1 and 5.000 US\$ in comparison to M2. The different cost shares behave in a similar manner as in the comparison between M2 and M1, being the  $C_{ATC}$  higher than in the previous missions. The seat-kilometer costs are very similar but still generally **lower** than the ones from M2.

Finally, the DOCs calculated with the AEA method and regarding different cabin configurations are shown in Table 4.17 (with additional cargo) and Table 4.18 (without additional cargo).

**Table 4.17** DOC for the A321LR in M3 for different cabin configurations, with additional cargo – AEA

Aircraft Configuration		160 PAX	170 PAX	180 PAX	186 PAX
DOC(YEAR)		61,67 M US\$	61,67 M US\$	61,67 M US\$	61,74 M US\$
CDEPRECIATION		9,66 M US\$	9,66 M US\$	9,66 M US\$	9,66 M US\$
CINTEREST		7,95 M US\$	7,95 M US\$	7,95 M US\$	7,95 M US\$
CINSURANCE		0,68 M US\$	0,68 M US\$	0,68 M US\$	0,68 M US\$
CFUEL		10,02 M US\$	10,02 M US\$	10,02 M US\$	10,02 M US\$
CMAINTENANCE		7,44 M US\$	7,44 M US\$	7,44 M US\$	7,50 M US\$
CCREW		2,90 M US\$	2,90 M US\$	2,90 M US\$	2,90 M US\$
CFEES		23,03 M US\$	23,03 M US\$	23,03 M US\$	23,03 M US\$
Economical DOC Interpretation					
Aircraft trip costs	Ca/c,t	\$154.955,47	\$154.955,47	\$154.955,47	\$155.118,78
Aircraft mile costs	Ca/c,m	\$38,78	\$38,78	\$38,78	\$38,82
Aircraft kilometer costs	Ca/c,km	\$20,94	\$20,94	\$20,94	\$20,96
Seat-mile costs	Cs,m	\$0,242	\$0,228	\$0,215	\$0,209
Seat-kilometer costs	Cs,km	\$0,131	\$0,123	\$0,116	\$0,113
Costs per flight hour	Ca/c,f	\$17.865,95	\$17.865,95	\$17.865,95	\$17.884,78
Costs per block hour	Ca/c,b	\$17.365,40	\$17.365,40	\$17.365,40	\$17.383,70

**Table 4.18** DOC for the A321LR in M3 for different cabin configurations, without additional cargo – AEA

Aircraft Configuration		160 PAX	170 PAX	180 PAX	186 PAX
DOC[M US\$/year]		60,63 M US\$	61,05 M US\$	61,48 M US\$	61,73 M US\$
CDepreciation[M US\$/year]		9,66 M US\$	9,66 M US\$	9,66 M US\$	9,66 M US\$
CInterest [M US\$/year]		7,95 M US\$	7,95 M US\$	7,95 M US\$	7,95 M US\$
CInsurance [M US\$/year]		0,68 M US\$	0,68 M US\$	0,68 M US\$	0,68 M US\$
CFuel[M US\$/year]		9,66 M US\$	9,80 M US\$	9,94 M US\$	10,02 M US\$
CMaintenance [M US\$/year]		7,50 M US\$	7,50 M US\$	7,50 M US\$	7,50 M US\$
CCrew [M US\$/year]		2,90 M US\$	2,90 M US\$	2,90 M US\$	2,90 M US\$
CFees [M US\$/year]		22,28 M US\$	22,57 M US\$	22,86 M US\$	23,03 M US\$
Economical DOC Interpretation					
Aircraft trip costs	Ca/c,t	\$152.326,67	\$153.397,25	\$154.467,83	\$155.110,18
Aircraft mile costs	Ca/c,m	\$38,12	\$38,39	\$38,66	\$38,82
Aircraft kilometer costs	Ca/c,km	\$20,58	\$20,73	\$20,87	\$20,96
Seat-mile costs	Cs,m	\$0,238	\$0,226	\$0,215	\$0,209
Seat-kilometer costs	Cs,km	\$0,129	\$0,122	\$0,116	\$0,113
Costs per flight hour	Ca/c,f	\$17.562,85	\$17.686,29	\$17.809,72	\$17.883,78
Costs per block hour	Ca/c,b	\$17.070,80	\$17.190,78	\$17.310,75	\$17.382,74

Differently, as in the TUB Method, M3 shows for both cases (a and b) the lowest DOCs per year, being the SKCs here also the lowest.

### 4.3 Comparison with Other Aircraft

In the same manner, the DOC methods were applied to the other considered aircraft. The upcoming tables present the respective results while regarding the different missions and cabin densities. The DOCs corresponding to the A321LR are shown again for direct comparison.

The left columns show the DOCs calculated with the TUB method, while the right side contains the results with the AEA method.

Furthermore, the tables distinguish between Missions (a) – in which the aircraft always fly with the maximum payload for the given range and cabin configuration – and Missions (b) –in which the aircraft fly without additional cargo.

A concluding overview of the missions' DOCs can be retrieved in Annex H – Summary of the DOC: All Missions.

### 4.3.1 M1 – 5600 km

Table 4.19 shows the results for the considered Mission 1a, meaning a range of 5600 km, with a standard density cabin configuration and additional cargo

For this Mission, while flying a standard density cabin configuration, only three of the total five aircraft can be employed. The range of this mission – 5.600 km – is already far beyond the ranges at MPL range of the A321ceo and the A321neo, so that a considerable payload limitation already exists due to the structural loads. Therefore, a standard cabin configuration of 200 pax is not feasible for the referred aircraft. On the other hand, the remaining aircraft can all be flown at their maximum payload, as this mission contemplates added cargo.

**Table 4.19** DOC comparison between the A321LR and similar aircraft: M1 – standard density cabin, with add. cargo

Method	TU Berlin			AEA		
Aircraft (Configuration)	A321LR(200)	A321XLR(200)	A330-9neo(380)	A321LR(200)	A321XLR(200)	A330-9neo(380)
DOC [M US\$/year]	36,45	37,05	76,34	66,47	67,45	132,66
CCAPITAL [M US\$/year]	8,37	8,45	21,23			
CHANDLING [M US\$/year]	2,05	1,94	4,15			
CLANDING [M US\$/year]	0,84	0,88	2,18			
CATC [M US\$/year]	4,75	4,85	7,78			
CCREW [M US\$/year]	3,29	3,29	4,76	2,86	2,86	3,97
CMAINT [M US\$/year]	2,25	2,27	4,27	7,63	7,65	14,85
CFUEL [M US\$/year]	14,89	15,37	31,97	10,71	11,06	23,10
CDepreciation[M US\$/year]				9,66	10,01	21,17
CInterest [M US\$/year]				7,95	8,24	17,42
CInsurance [M US\$/year]				0,68	0,70	1,48
CFees [M US\$/year]				26,99	26,93	50,66
Economical DOC Interpretation						
Aircraft trip costs [US\$/ flight]	51.122	51.969	103.301	129.580	131.474	248.424
Aircraft mile costs [US\$/ nm]	16,91	17,19	34,16	42,85	43,48	82,16
Aircraft kilometer costs [US\$/ km]	9,13	9,28	18,45	23,14	23,48	44,36
Seat-mile costs [US\$/ nm]	0,085	0,086	0,090	0,214	0,217	0,216
Seat kilometer costs [US\$/ km]	0,046	0,046	0,049	0,116	0,117	0,117
Costs per flight hour [US\$/ h]	7.746	7.874	16.397	19.742	20.031	39.606
Costs per block hour [US\$/ h]	6.064	6.165	12.706	19.018	19.296	38.088



The annual DOC of the aircraft, as well as the majority of the cost components, are coherent to the order of their MTOW. In both methods, the A330-900neo shows the highest DOC, whereas the A321LR has the lowest operating costs. However, DOCs of the XLR are minimally higher than those of the LR, with the TUB method and the AEA method showing a difference of 0,6 and 1,0 M US\$ per year, respectively. Generally, the costs for both single-aisle aircraft are around 50% less when compared to the bigger A339. Due to the higher number of flight attendants (i.e., seven vs. four), the crew costs are also higher in the A339 for both methods.

Considering the TUB method, due to the higher MPL, the handling costs of the LR are slightly higher than those of the XLR, but still, only half of the ones from the A339 – this observation is reassured in the  $C_{FEES}$  of the AEA method. The biggest stake of the DOCs is taken by the fuel costs followed by the route independent capital costs. The  $C_{FUEL}$  of the XLR are slightly higher than the ones from the LR (higher MTOW). – the  $C_{FUEL}$  show lower levels in the AEA, but the trend is the same. Furthermore, the maintenance costs of the LR and XLR are appointed as almost equal.

In the TUB method, the aircraft trip costs of the LR are 51.122 US\$/flight, around 1,6% less than the XLR and around 50% less than the A339. SKCs of around 0,046 US\$ are appointed for the smaller aircraft, which are 0,03 US\$ lower than the A339, which carries more passengers, but in a similar density. The aircraft trip costs of the XLR are in the AEA method again 1,6% lower than the LR, but the SKCs are roughly equal to those of the A339.

The flight and block-hour costs show a similar trend to the aircraft-trip costs.

Table 4.20 shows the results for the same mission and cabin density but without additional cargo. In doing so, the MPL is not reached by any of the aircraft, which in other words means that more passengers could be carried.

This table shows that the handling costs decrease when compared to their equivalent with cargo. Furthermore, in the TUB method, the  $C_{HANDLING}$  of the LR and XLR are the same, given the fact they carry the same number of passengers (200 pax). In the AEA method, this observation is reassured in the  $C_{FEES}$ , which also decrease compared to their correspondent with cargo – less 6% for A321 aircraft and less 8 % for A339.

The fuel costs are also lower because of the aircraft being lighter and thus consuming less fuel for the given mission – at least 4% for both missions. In the same way, the SKCs are also minimally lower, being the SKC of the A339 now equal to the LR in the AEA method (XLR 3% higher) at 0,112 US\$/pax km.

**Table 4.20** DOC comparison between the A321LR and similar aircraft: M1 – standard density cabin, without add. cargo

Method	TU Berlin			AEA		
	A321LR(200)	A321XLR(200)	A330-9neo(380)	A321LR(200)	A321XLR(200)	A330-9neo(380)
DOC[M US\$/year]	35,27	36,20	73,91	64,21	65,90	127,83
CCAPITAL[M US\$/year]	8,37	8,45	21,23			
CHANDLING[M US\$/year]	1,69	1,69	3,32			
CLANDING[M US\$/year]	0,84	0,88	2,18			
CATC[M US\$/year]	4,75	4,85	7,78			
CCREW[M US\$/year]	3,29	3,29	4,76	2,86	2,86	3,97
CMAINT[M US\$/year]	2,25	2,27	4,27	7,56	7,65	14,85
CFUEL[M US\$/year]	14,08	14,77	30,36	10,13	10,63	21,94
CDepreciation[M US\$/year]				9,66	10,01	21,17
CInterest [M US\$/year]				7,95	8,24	17,42
CInsurance [M US\$/year]				0,68	0,70	1,48
CFees [M US\$/year]				25,38	25,81	47,00
Economical DOC Interpretation						
Aircraft trip costs [US\$/ flight]	49.473	50.776	100.009	125.172	128.450	239.390
Aircraft mile costs [US\$/ nm]	16,36	16,79	33,07	41,40	42,48	79,17
Aircraft kilometer costs [US\$/ km]	8,83	9,07	17,86	22,35	22,94	42,75
Seat-mile costs [US\$/ nm]	0,082	0,084	0,087	0,207	0,212	0,208
Seat kilometer costs [US\$/ km]	0,044	0,045	0,047	0,112	0,115	0,112
Costs per flight hour [US\$/ h]	7.496	7.693	15.874	19.071	19.570	38.166
Costs per block hour [US\$/ h]	5.869	6.023	12.301	18.371	18.852	36.703

Table 4.21 shows the results for the same mission and additional cargo with a high-density cabin configuration. The results without additional cargo are depicted in Table 4.22. For the A321 family, this translates into 20 added pax, and for the A339, 40 pax.

Firstly, the added seats require at least one added flight attendant for both aircraft types, i.e., from four to five for the A321 family and from eight to nine for the A339. This automatically implies higher  $C_{CREW}$  of a least 0,5 M US\$/yr in the TUB method or 0,3 M US\$/yr in the AEA method. The  $C_{HANDLING}$  or  $C_{FEES}$  also generally increase.

Second, the added seats contribute to a further lowering of the SKCs – one to two cents of the US\$ per pax/km in the TUB method and one to four cents of the US\$ in the AEA method, across the aircraft, being the SKCs of the A321LR and the A339 once more very similar in the latest.

On the other hand, a higher  $C_{FUEL}$  can be observed in the mission without cargo (ca. 3% across all methods) compared to the standard cabin configuration due to the higher payload and, therefore, higher fuel demand. For the mission with additional cargo, the  $C_{FUEL}$  are the same as in a standard density cabin configuration because the margin until the MPL was completed with the referred cargo anyway, translating into the same carried payload.

Lastly, due to the changes stated so far, the yearly DOCs increase minimally in comparison to the standard density cabin configuration. In missions with additional cargo, this change ranges in both methods from 0,5% to 1% per year. For missions without additional cargo, the increase ranges between 1,7% to 2,5% higher DOCs per year.

**Table 4.21** DOC comparison between the A321LR and similar aircraft: M1 – high-density cabin, with additional cargo

Method	TU Berlin			AEA		
Aircraft (Configuration)	A321LR(220)	A321XLR(220)	A330-9neo(420)	A321LR(220)	A321XLR(220)	A330-9neo(420)
DOC [M US\$/year]	36,82	37,42	76,71	66,68	67,73	132,94
CCAPITAL [M US\$/year]	8,37	8,45	21,23			
CHANDLING [M US\$/year]	2,05	1,94	4,15			
CLANDING [M US\$/year]	0,84	0,88	2,18			
CATC [M US\$/year]	4,75	4,85	7,78			
CCREW [M US\$/year]	3,66	3,66	5,12	3,14	3,14	4,26
CMAINT [M US\$/year]	2,25	2,27	4,27	7,56	7,65	14,85
CFUEL [M US\$/year]	14,89	15,37	31,97	10,71	11,06	23,10
CDepreciation[M US\$/year]				9,66	10,01	21,17
CInterest [M US\$/year]				7,95	8,24	17,42
CInsurance [M US\$/year]				0,68	0,70	1,48
CFees [M US\$/year]				26,98	26,93	50,66
Economical DOC Interpretation						
Aircraft trip costs [US\$/ flight]	51.636	52.483	103.796	129.973	132.026	248.952
Aircraft mile costs [US\$/ nm]	17,08	17,36	34,33	42,98	43,66	82,33
Aircraft kilometer costs [US\$/ km]	9,22	9,37	18,53	23,21	23,58	44,46
Seat-mile costs [US\$/ nm]	0,078	0,079	0,082	0,195	0,198	0,196
Seat kilometer costs [US\$/ km]	0,042	0,043	0,044	0,105	0,107	0,106
Costs per block hour [US\$/h]	7.824	7.952	16.476	19.802	20.115	39.690
Costs per block hour [US\$/ h]	6.125	6.226	12.767	19.076	19.377	38.169

**Table 4.22** DOC comparison between the A321LR and similar aircraft: M1 – high-density cabin, without add. cargo

Method Aircraft (Configuration)	TU Berlin			AEA		
	A321LR(220)	A321XLR(220)	A330-9neo(420)	A321LR(220)	A321XLR(220)	A330-9neo(420)
DOC[M US\$/year]	36,19	37,14	75,31	65,52	67,21	130,16
CCAPITAL[M US\$/year]	8,37	8,45	21,23			
CHANDLING[M US\$/year]	1,86	1,86	3,67			
CLANDING[M US\$/year]	0,84	0,88	2,18			
CATC[M US\$/year]	4,75	4,85	7,78			
CCREW[M US\$/year]	3,66	3,66	5,12	3,14	3,14	4,26
CMAINT[M US\$/year]	2,25	2,27	4,27	7,56	7,65	14,85
CFUEL[M US\$/year]	14,46	15,17	31,04	10,40	10,92	22,43
CDepreciation[M US\$/year]				9,66	10,01	21,17
CInterest [M US\$/year]				7,95	8,24	17,42
CInsurance [M US\$/year]				0,68	0,70	1,48
CFees [M US\$/year]				26,13	26,56	48,55
Economical DOC Interpretation						
Aircraft trip costs [US\$/ flight]	50.759	52.084	101.902	127.715	131.016	243.754
Aircraft mile costs [US\$/ nm]	16,79	17,22	33,70	42,24	43,33	80,61
Aircraft kilometer costs [US\$/ km]	9,06	9,30	18,20	22,81	23,40	43,53
Seat-mile costs [US\$/ nm]	0,076	0,078	0,080	0,192	0,197	0,192
Seat kilometer costs [US\$/ km]	0,041	0,042	0,043	0,104	0,106	0,104
Costs per flight hour [US\$/ h]	7.691	7.891	16.175	19.458	19.961	38.861
Costs per block hour [US\$/ h]	6.021	6.178	12.534	18.744	19.229	37.372

Table 4.23 shows the results for the M1a with a low-density cabin configuration, whereas Table 4.24 shows the corresponding results without additional cargo. At this given range (5600 km), the allowed payload of the A321ceo is only around 3.500 kg, and for A321neo, 16.700 kg. With the considered  $m_{pax}$  of 97 kg, this translates into a total of **36** pax and **172** pax for the two aircraft, respectively.

For the remaining aircraft of the A321 family, a low-density configuration of **180** pax (20 less) is assumed, and for the A339, **340** pax (40 less).

**Table 4.23** DOC comparison between the A321LR and similar aircraft: M1 – low-density cabin, with additional cargo

Method	TU Berlin					AEA				
Aircraft (Configuration)	A321ceo(36)	A321neo(172)	A321LR(180)	A321XLR(180)	A330-9neo(340)	A321ceo(36)	A321neo(172)	A321LR(180)	A321XLR(180)	A330-9neo(340)
DOC [M US\$/year]	29,91	33,47	36,45	37,05	75,97	51,94	61,06	66,39	67,45	132,38
CCAPITAL [M US\$/year]	7,86	8,19	8,37	8,45	21,23					
CHANDLING [M US\$/year]	0,29	1,46	2,05	1,94	4,15					
CLANDING [M US\$/year]	0,74	0,81	0,84	0,88	2,18					
CATC [M US\$/year]	4,34	4,66	4,75	4,85	7,78					
CCREW [M US\$/year]	2,20	3,29	3,29	3,29	4,39	2,01	2,86	2,86	2,86	3,69
CMAINT [M US\$/year]	2,15	2,23	2,25	2,27	4,27	7,12	7,43	7,56	7,65	14,85
CFUEL [M US\$/year]	12,34	12,83	14,89	15,37	31,97	8,84	9,23	10,71	11,06	23,10
CDepreciation [M US\$/year]						8,48	9,27	9,66	10,01	21,17
CInterest [M US\$/year]						6,97	7,63	7,95	8,24	17,42
CInsurance [M US\$/year]						0,59	0,65	0,68	0,70	1,48
CFees [M US\$/year]						17,93	23,99	26,98	26,93	50,66
Economical DOC Interpretation										
Aircraft trip costs [US\$/ flight]	43.990	46.946	51.122	51.969	102.805	106.653	119.025	129.422	131.474	247.896
Aircraft mile costs [US\$/ nm]	14,55	15,53	16,91	17,19	34,00	35,27	39,36	42,80	43,48	81,98
Aircraft kilometer costs [US\$/ km]	7,86	8,38	9,13	9,28	18,36	19,05	21,25	23,11	23,48	44,27
Seat-mile costs [US\$/ nm]	0,404	0,090	0,094	0,095	0,100	0,980	0,229	0,238	0,240	0,241
Seat kilometer costs [US\$/ km]	0,218	0,049	0,051	0,052	0,054	0,529	0,124	0,128	0,130	0,130
Costs per block hour [US\$/h]	6.284	7.113	7.746	7.874	16.318	15.358	18.134	19.718	20.031	39.522
Costs per block hour [US\$/h]	4.982	5.569	6.064	6.165	12.645	14.824	17.469	18.995	19.296	38.007

**Table 4.24** DOC comparison between the A321LR and similar aircraft: M1 – low-density cabin, without additional cargo

Method	TU Berlin					AEA				
Aircraft (Configuration)	A321ceo(36)	A321neo(172)	A321LR(180)	A321XLR(180)	A330-9neo(340)	A321ceo(36)	A321neo(172)	A321LR(180)	A321XLR(180)	A330-9neo(340)
DOC [M US\$/year]	29,91	33,45	34,72	35,64	72,51	51,47	61,02	63,19	64,86	125,50
CCAPITAL [M US\$/year]	7,86	8,19	8,37	8,45	21,23					
CHANDLING [M US\$/year]	0,29	1,45	1,52	1,52	2,97					
CLANDING [M US\$/year]	0,74	0,81	0,84	0,88	2,18					
CATC [M US\$/year]	4,34	4,66	4,75	4,85	7,78					
CCREW [M US\$/year]	2,20	3,29	3,29	3,29	4,39	2,01	2,86	2,86	2,86	3,69
CMAINT [M US\$/year]	2,15	2,23	2,25	2,27	4,27	7,12	7,43	7,56	7,65	14,85
CFUEL [M US\$/year]	12,34	12,82	13,69	14,38	29,68	8,84	9,22	9,85	10,34	21,44
CDepreciation [M US\$/year]						8,48	9,27	9,66	10,01	21,17
CInterest [M US\$/year]						6,97	7,63	7,95	8,24	17,42
CInsurance [M US\$/year]						0,59	0,65	0,68	0,70	1,48
CFees [M US\$/year]						17,46	23,96	24,64	25,06	45,45
Economical DOC Interpretation										
Aircraft trip costs [US\$/ flight]	43.990	46.914	48.701	49.981	98.116	105.690	118.941	123.180	126.437	235.027
Aircraft mile costs [US\$/ nm]	14,55	15,52	16,11	16,53	32,45	34,95	39,34	40,74	41,81	77,73
Aircraft kilometer costs [US\$/ km]	7,86	8,38	8,70	8,93	17,52	18,87	21,24	22,00	22,58	41,97
Seat-mile costs [US\$/ nm]	0,404	0,090	0,089	0,092	0,095	0,971	0,229	0,226	0,232	0,229
Seat kilometer costs [US\$/ km]	0,218	0,049	0,048	0,050	0,052	0,524	0,123	0,122	0,125	0,123
Costs per flight hour [US\$/h]	6.284	7.108	7.379	7.573	15.574	15.219	18.121	18.767	19.264	37.470
Costs per block hour [US\$/h]	4.982	5.565	5.777	5.929	12.068	14.690	17.457	18.079	18.557	36.034

Because of the major difference in pax number, the ceo shows results that differ considerably from the other aircraft. Still, these values do not necessarily reflect proportionally in the yearly

DOCs decrease when compared to the LR. For example, while the pax difference from 180 to 36 pax represents an 80 % reduction, the yearly DOC reduction is only around 17,9% or less per year (e.g., 29,91 M US\$ vs. 36,45 in M1a).

This can be explained by means of the fixed costs per year, which are independent of the mission and payload, and even by route-dependent costs, which will be similar if the aircraft share the same number of flights per annum. Some examples are the  $C_{CAPITAL}$  or  $C_{DEPRECIATION}$ ,  $C_{INSURANCE}$ ,  $C_{LANDING}$ , and  $C_{MAINTENANCE}$ .

The yearly DOCs for the A321neo are around 8,7% less for a mission with additional cargo when compared to the LR, which can be mainly explained by the higher  $C_{HANDLING}$  due to the higher Payload and higher  $C_{FUEL}$  due to the higher MTOW of the LR. The other costs are still less in the neo but somehow comparable to the LR. In a mission without cargo, the DOCs of the referred aircraft are much more similar, as a difference of around 3,7 % is detected. This is because, in terms of pax, the difference is minimal (8 passengers).

For the LR and XLR, this cabin configuration still demands the same amount of flight attendants compared to the standard cabin configuration, whereas for the A339, one additional FA is needed. On the other hand, the smaller number of passengers contributes to lower handling, as well as fuel costs (without added cargo), but lastly, to a higher SKC. For example, the SKCs for the LR increase by around 10,9 % with additional cargo and by a mean of 9% without additional cargo.

Due to the changes stated so far, the yearly DOCs for missions with additional cargo remain around the **same level**, and for Missions without additional cargo, a **slight decrease** is observed at around 1,6 % for both methods.

### 4.3.2 M2 – 6500 km

This mission represents an increase of 900 km compared to M1, which has consequences on the payload that the A321 family aircraft can transport. These consequences are more evident in the case of a high-density cabin configuration. The A321ceo, as well as the A321neo, cannot be employed on this mission anymore. The A339 remains exempt from payload reductions due to its higher range at the maximum payload of 7.707 km.

The route-independent costs remain the same compared to M1 for both methods. The DOCs for all considered aircraft are generally lower due to reduced flight trips per annum that come with exclusively flying longer-range missions – e.g., 637 FC in M2 vs. 713 in M1 for the LR and XLR, in compliance with the concepts explained in Section 2.4.3.

Table 4.25 shows the results for the considered mission 2a, with a standard density cabin configuration and additional cargo. In contrast, Table 4.26 shows the results for the considered mission and standard density cabin configuration without additional cargo.

The DOCs of the considered aircraft are generally lower. A reduction of around 1,7% was detected for both methods in comparison with M1, even though the aircraft trip costs are higher due to the reduced number of flight-cycles – mean of 10% across both methods and slightly higher in the heavier aircraft (XLR and A339).

The  $C_{HANDLING}$  or  $C_{FEES}$ , the  $C_{LANDING}$ , as well as the  $C_{MAINTENANCE}$  are also lower due to the reduced FC. On the other hand, the  $C_{ATC}$  are higher since they depend on the flown distance (see Chapter 2.4).

The effect of the reduced FC is predominant in the  $C_{FUEL}$  of the LR, while the effects of the higher MTOW and bigger fuel tanks are predominant in the case of the XLR and A339. Therefore, the  $C_{FUEL}$  of the LR generally decreases, whereas the  $C_{FUEL}$  of the XLR and A339 increase when compared to M1.

The SKCs for all aircraft are lower than in M1, being the gap between M2a and M2b higher than between M1a and M1b, especially for the XLR and A339.

**Table 4. 25** DOC comparison between the A321LR and similar aircraft: M2 – standard density cabin, with add. cargo

Method Aircraft (Configuration)	TU Berlin			AEA		
	A321LR(200)	A321XLR(200)	A330-9neo(380)	A321LR(200)	A321XLR(200)	A330-9neo(380)
DOC[M US\$/year]	35,83	37,45	76,82	63,71	66,28	130,02
CCAPITAL[M US\$/year]	8,37	8,45	21,23			
CHANDLING[M US\$/year]	1,62	1,73	3,69			
CLANDING[M US\$/year]	0,75	0,78	1,94			
CATC[M US\$/year]	4,93	5,03	8,04			
CCREW[M US\$/year]	3,29	3,29	4,76	2,88	2,88	4,01
CMAINT[M US\$/year]	2,21	2,22	4,12	7,49	7,57	14,71
CFUEL[M US\$/year]	14,67	15,94	33,04	10,32	11,21	23,45
CDepreciation[M US\$/year]				9,66	10,01	21,17
CInterest [M US\$/year]				7,95	8,24	17,42
CInsurance [M US\$/year]				0,68	0,70	1,48
CFees [M US\$/year]				24,74	25,67	47,77
Economical DOC Interpretation						
Aircraft trip costs [US\$/flight]	56.255	58.796	116.751	142.211	147.952	278.407
Aircraft mile costs [US\$/nm]	16,03	16,75	33,26	40,52	42,15	79,32
Aircraft kilometer costs [US\$/km]	8,65	9,05	17,96	21,88	22,76	42,83
Seat-mile costs [US\$/nm]	0,080	0,084	0,088	0,203	0,211	0,209
Seat kilometer costs [US\$/km]	0,043	0,045	0,047	0,109	0,114	0,113
Costs per flight hour [US\$/h]	7.402	7.736	15.993	18.667	19.420	38.240
Costs per block hour [US\$/h]	5.966	6.235	12.788	18.074	18.803	36.971

**Table 4. 26** DOC comparison between the A321LR and similar aircraft: M2 – standard density cabin, without add. cargo

Method	TU Berlin			AEA		
	A321LR(200)	A321XLR(200)	A330-9neo(380)	A321LR(200)	A321XLR(200)	A330-9neo(380)
Aircraft (Configuration)						
DOC[M US\$/year]	35,44	36,61	74,43	63,11	64,20	125,14
CCAPITAL[M US\$/year]	8,37	8,45	21,23			
CHANDLING[M US\$/year]	1,51	1,51	2,96			
CLANDING[M US\$/year]	0,75	0,78	1,94			
CATC[M US\$/year]	4,93	5,03	8,04			
CCREW[M US\$/year]	3,29	3,29	4,76	2,88	2,88	4,01
CMAINT[M US\$/year]	2,21	2,22	4,12	7,55	7,59	14,68
CFUEL[M US\$/year]	14,39	15,32	31,38	10,12	1,00	2,00
CDepreciation[M US\$/year]				9,66	10,01	21,17
Cinterest [M US\$/year]				7,95	8,24	17,42
Cinsurance [M US\$/year]				0,68	0,70	1,48
CFees [M US\$/year]				24,27	24,69	44,57
Economical DOC Interpretation						
Aircraft trip costs [US\$/ flight]	55.644	57.468	113.109	140.869	143.306	267.961
Aircraft mile costs [US\$/ nm]	15,85	16,37	32,23	40,14	40,83	76,35
Aircraft kilometer costs [US\$/ km]	8,56	8,84	17,40	21,67	22,05	41,22
Seat-mile costs [US\$/ nm]	0,079	0,082	0,085	0,201	0,204	0,201
Seat kilometer costs [US\$/ km]	0,043	0,044	0,046	0,108	0,110	0,108
Costs per flight hour [US\$/ h]	7.322	7.562	15.494	18.491	18.811	36.805
Costs per block hour [US\$/ h]	5.901	6.094	12.389	17.903	18.213	35.584

Table 4.27 shows the results for M2 regarding a high-density cabin configuration and with additional cargo. The results for the equivalent mission without cargo are presented in Table 4.28.

In this mission, the first payload restriction for the LR takes place, as it is not capable of carrying 220 pax à 97 kg anymore, due to structural load limitations (maximum now around 20,8 t) – for comparison, the XLR could carry a maximum of 230 pax (22,3 t). Because of this, missions M2a and M2b are almost identical for the LR.

The DOCs remain lower than the correspondent ones in M1. Because of the added pax, the SKCs continue to decrease until reaching the lowest levels so far. Especially the A339 profits from this mission, as its SKCs are even lower than those of the LR in the case of the AEA method (6 pax less than normal high-density). The remaining correlations between flying with additional cargo or not are similar to those detected between M1a and M1b.



**Table 4.27** DOC comparison between the A321LR and similar aircraft: M2 – high-density cabin, with add. cargo

Method	TU Berlin			AEA		
Aircraft (Configuration)	A321LR(214)*	A321XLR(220)	A330-9neo(420)	A321LR(214)*	A321XLR(220)	A330-9neo(420)
DOC[M US\$/year]	36,20	37,82	77,19	64,00	66,57	130,30
CCAPITAL[M US\$/year]	8,37	8,45	21,23			
CHANDLING[M US\$/year]	1,62	1,73	3,69			
CLANDING[M US\$/year]	0,75	0,78	1,94			
CATC[M US\$/year]	4,93	5,03	8,04			
CCREW[M US\$/year]	3,66	3,66	5,12	3,17	2,88	4,30
CMaint[M US\$/year]	2,21	2,22	4,12	7,49	7,57	14,71
CFUEL[M US\$/year]	14,67	15,94	33,04	10,32	11,21	23,45
CDepreciation[M US\$/year]				9,66	10,01	21,17
CInterest [M US\$/year]				7,95	8,24	17,42
CInsurance [M US\$/year]				0,68	0,70	1,48
CFees [M US\$/year]				24,74	25,67	47,77
Economical DOC Interpretation						
Aircraft trip costs [US\$/flight]	56.829	59.371	117.307	142.848	147.952	279.017
Aircraft mile costs [US\$/nm]	16,19	16,92	33,42	40,70	42,15	79,50
Aircraft kilometer costs [US\$/km]	8,74	9,13	18,05	21,98	22,76	42,93
Seat-mile costs [US\$/nm]	0,076	0,077	0,080	0,190	0,192	0,189
Seat kilometer costs [US\$/km]	0,041	0,042	0,043	0,103	0,104	0,102
Costs per flight hour [US\$/h]	7.478	7.812	16.069	18.750	19.420	38.324
Costs per block hour [US\$/h]	6.026	6.296	12.848	18.155	18.803	37.052

**Table 4.28** DOC comparison between the A321LR and similar aircraft: M2 – high-density cabin, without add. cargo

Method	TU Berlin			AEA		
Aircraft (Configuration)	A321LR(214)*	A321XLR(220)	A330-9neo(420)	A321LR(214)*	A321XLR(220)	A330-9neo(420)
DOC[M US\$/year]	36,19	37,54	75,81	64,04	66,09	127,38
CCAPITAL[M US\$/year]	8,37	8,45	21,23			
CHANDLING[M US\$/year]	1,61	1,66	3,27			
CLANDING[M US\$/year]	0,75	0,78	1,94			
CATC[M US\$/year]	4,93	5,03	8,04			
CCREW[M US\$/year]	3,66	3,66	5,12	3,17	3,17	4,30
CMaint[M US\$/year]	2,21	2,22	4,12	7,55	7,57	14,71
CFUEL[M US\$/year]	14,66	15,73	32,08	10,31	11,07	22,37
CDepreciation[M US\$/year]				9,66	10,01	21,17
CInterest [M US\$/year]				7,95	8,24	17,42
CInsurance [M US\$/year]				0,68	0,70	1,48
CFees [M US\$/year]				24,73	25,34	45,93
Economical DOC Interpretation						
Aircraft trip costs [US\$/flight]	56.813	58.927	115.211	142.948	147.533	272.769
Aircraft mile costs [US\$/nm]	16,19	16,79	32,83	40,73	42,04	77,72
Aircraft kilometer costs [US\$/km]	8,74	9,07	17,72	21,99	22,70	41,96
Seat-mile costs [US\$/nm]	0,076	0,076	0,078	0,190	0,191	0,185
Seat kilometer costs [US\$/km]	0,041	0,041	0,042	0,103	0,103	0,100
Costs per flight hour [US\$/h]	7.475	7.754	15.782	18.764	19.365	37.466
Costs per block hour [US\$/h]	6.025	6.249	12.619	18.167	18.750	36.222

Table 4.29 shows the results for the considered mission 2 regarding a low-density cabin configuration and with additional cargo. The correspondent Mission without additional cargo is shown in Table 4.30

For the LR and XLR, the DOCs remain the same as in M2a with a standard cabin configuration because there is no cabin crew reduction, and the fewer pax are complemented with cargo, which drives  $C_{HANDLING}$  to the previous level. For the A339, there is a slight decrease due to the cabin crew reduction. In case of not transporting cargo, the DOC generally decrease, as expected.

The SKCs for this mission are generally higher than the correspondent ones in a standard cabin configuration, as well as their equivalent in M1.

**Table 4.29** DOC comparison between the A321LR and similar aircraft: M2 – low-density cabin, with additional cargo

Method	TU Berlin			AEA		
	A321LR(180)	A321XLR(180)	A330-9neo(340)	A321LR(180)	A321XLR(180)	A330-9neo(340)
DOC[M US\$/year]	35,83	37,45	76,46	63,71	66,28	129,73
CCAPITAL[M US\$/year]	8,37	8,45	21,23			
CHANDLING[M US\$/year]	1,62	1,73	3,69			
CLANDING[M US\$/year]	0,75	0,78	1,94			
CATC[M US\$/year]	4,93	5,03	8,04			
CCREW[M US\$/year]	3,29	3,29	4,39	2,88	2,88	3,73
CMAINT[M US\$/year]	2,21	2,22	4,12	7,49	7,57	14,71
CFUEL[M US\$/year]	14,67	15,94	33,04	10,32	11,21	23,45
CDepreciation[M US\$/year]				9,66	10,01	21,17
CInterest [M US\$/year]				7,95	8,24	17,42
CInsurance [M US\$/year]				0,68	0,70	1,48
CFees [M US\$/year]				24,74	25,67	47,77
Economical DOC Interpretation						
Aircraft trip costs [US\$/ flight]	56.255	58.796	116.194	142.211	147.952	277.797
Aircraft mile costs [US\$/ nm]	16,03	16,75	33,11	40,52	42,15	79,15
Aircraft kilometer costs [US\$/ km]	8,65	9,05	17,88	21,88	22,76	42,74
Seat-mile costs [US\$/ nm]	0,089	0,093	0,097	0,225	0,234	0,233
Seat kilometer costs [US\$/ km]	0,048	0,050	0,053	0,122	0,126	0,126
Costs per flight hour [US\$/ h]	7.402	7.736	15.917	18.667	19.420	38.156
Costs per block hour [US\$/ h]	5.966	6.235	12.727	18.074	18.803	36.890

**Table 4.30** DOC comparison between the A321LR and similar aircraft: M2 – low-density cabin, without add. cargo

Method	TU Berlin			AEA		
	A321LR(180)	A321XLR(180)	A330-9neo(340)	A321LR(180)	A321XLR(180)	A330-9neo(340)
Aircraft (Configuration)						
DOC[M US\$/year]	34,90	36,04	73,04	62,19	63,28	123,11
CCAPITAL[M US\$/year]	8,37	8,45	21,23			
CHANDLING[M US\$/year]	1,36	1,36	2,65			
CLANDING[M US\$/year]	0,75	0,78	1,94			
CATC[M US\$/year]	4,93	5,03	8,04			
CCREW[M US\$/year]	3,29	3,29	4,39	2,88	2,88	3,73
CMAINT[M US\$/year]	2,21	2,22	4,12	7,55	7,59	14,71
CFUEL[M US\$/year]	14,00	14,91	30,67	9,85	9,82	21,39
CDepreciation[M US\$/year]				9,66	10,01	21,17
Cinterest [M US\$/year]				7,95	8,24	17,42
Cinsurance [M US\$/year]				0,68	0,70	1,48
CFees [M US\$/year]				23,62	24,04	43,21
Economical DOC Interpretation						
Aircraft trip costs [US\$/ flight]	54.794	56.584	111.007	138.810	141.246	263.620
Aircraft mile costs [US\$/ nm]	15,61	16,12	31,63	39,55	40,24	75,11
Aircraft kilometer costs [US\$/ km]	8,43	8,71	17,08	21,36	21,73	40,56
Seat-mile costs [US\$/ nm]	0,087	0,090	0,093	0,220	0,224	0,221
Seat kilometer costs [US\$/ km]	0,047	0,048	0,050	0,119	0,121	0,119
Costs per flight hour [US\$/ h]	7.210	7.445	15.206	18.220	18.540	36.209
Costs per block hour [US\$/ h]	5.811	6.000	12.158	17.642	17.951	35.007

### 4.3.3 M3 – 7400 km

This mission represents an increase of 900 km compared to M2 and 1.800 km compared to M1., coinciding with the range at MFW of the LR. In other words, for the first time, the LR will fly with filled fuel tanks, as seen before. For this reason, the expected variations are higher, as the allowed payloads are considerably reduced not only for the LR but also for the XLR in all cabin configurations. On the other side, the A339 can still be employed in this mission without payload reduction.

Table 4.31 shows the results for M3 with standard density cabin configuration and additional cargo (M3a), and Table 4.32 shows the correspondent mission without additional cargo (M3b).

Here, the DOCs are again generally lower than in M1 due to the considerable flight-cycle reduction (e.g., 570 FC in M3 vs. 713 in M1 for LR and XLR). An exception in the TUB method is the A339, whose DOCs are appointed to be higher than M1 mainly because of the higher  $C_{FUEL}$  and  $C_{ATC}$  surpassing the effect of the reduced FC. These referred cost units are generally the ones that are mostly influenced by the range increase in all aircraft.

In the mission without additional cargo, the SKCs are in both methods all lower than in M1 except for the LR, which shows a higher SKC with 14 fewer passengers than usual. Nevertheless, the impact of the extended flight distance is evident, as this point is virtually counterproductive to the LR.

In the TUB method in general, as well as in the AEA method without additional cargo, the XLR shows the lowest SKC with one or two cents of the US\$ advantage towards the other aircraft. In M3b with the AEA, the A339 shows minimal benefit towards the XLR (one cent).

**Table 4.31** DOC comparison between the A321LR and similar aircraft: M3 – standard density cabin, with add. cargo

Method	TU Berlin			AEA		
	A321LR(186)*	A321XLR(200)	A330-9neo(380)	A321LR(186)*	A321XLR(200)	A330-9neo(380)
DOC[M US\$/year]	35,12	36,78	77,21	61,74	64,19	127,98
CCAPITAL[M US\$/year]	8,37	8,45	21,23			
CHANDLING[M US\$/year]	1,26	1,41	3,33			
CLANDING[M US\$/year]	0,67	0,70	1,75			
CATC[M US\$/year]	5,02	5,12	8,24			
CCREW[M US\$/year]	3,29	3,29	4,76	2,90	2,90	4,04
CMaint[M US\$/year]	2,17	2,18	4,00	7,50	7,53	14,60
CFUEL[M US\$/year]	14,35	15,63	33,90	10,02	1,00	2,00
CDepreciation[M US\$/year]				9,66	10,01	21,17
CInterest [M US\$/year]				7,95	8,24	17,42
CInsurance [M US\$/year]				0,68	0,70	1,48
CFees [M US\$/year]				23,03	24,47	45,53
Economical DOC Interpretation						
Aircraft trip costs [US\$/ flight]	61.618	64.530	130.201	155.119	161.281	308.375
Aircraft mile costs [US\$/ nm]	15,42	16,15	32,59	38,82	40,36	77,18
Aircraft kilometer costs [US\$/ km]	8,33	8,72	17,59	20,96	21,79	41,67
Seat-mile costs [US\$/ nm]	0,083	0,081	0,086	0,209	0,202	0,203
Seat kilometer costs [US\$/ km]	0,045	0,044	0,046	0,113	0,109	0,110
Costs per flight hour [US\$/ h]	7.083	7.417	15.687	17.885	18.595	37.205
Costs per block hour [US\$/ h]	5.852	6.128	12.853	17.384	18.074	36.116

**Table 4.32** DOC comparison between the A321LR and similar aircraft: M3 – standard density cabin, without add. cargo

Method	TU Berlin			AEA		
	A321LR(186)*	A321XLR(200)	A330-9neo(380)	A321LR(186)*	A321XLR(200)	A330-9neo(380)
DOC[M US\$/year]	35,12	36,54	74,84	61,73	63,10	123,94
CCAPITAL[M US\$/year]	8,37	8,45	21,23			
CHANDLING[M US\$/year]	1,25	1,35	2,67			
CLANDING[M US\$/year]	0,67	0,70	1,75			
CATC[M US\$/year]	5,02	5,12	8,24			
CCREW[M US\$/year]	3,29	3,29	4,76	2,90	2,90	4,04
CMaint[M US\$/year]	2,17	2,18	4,00	7,50	7,53	14,60
CFUEL[M US\$/year]	14,35	15,44	32,19	10,02	1,00	2,00
CDepreciation[M US\$/year]				9,66	10,01	21,17
CInterest [M US\$/year]				7,95	8,24	17,42
CInsurance [M US\$/year]				0,68	0,70	1,48
CFees [M US\$/year]				23,03	23,84	42,69
Economical DOC Interpretation						
Aircraft trip costs [US\$/flight]	61.614	64.107	126.210	155.110	158.552	298.641
Aircraft mile costs [US\$/nm]	15,42	16,04	31,59	38,82	39,68	74,74
Aircraft kilometer costs [US\$/km]	8,33	8,66	17,06	20,96	21,43	40,36
Seat-mile costs [US\$/nm]	0,083	0,080	0,083	0,209	0,198	0,197
Seat kilometer costs [US\$/km]	0,045	0,043	0,045	0,113	0,107	0,106
Costs per flight hour [US\$/h]	7.082	7.369	15.206	17.884	18.281	36.031
Costs per block hour [US\$/h]	5.851	6.088	12.459	17.383	17.768	34.976

Table 4.33 shows the results for M3 regarding a high-density cabin configuration and with additional cargo, whereas Table 4.34 shows the correspondent mission without additional cargo.

Here, the effects of the extended range become even more evident in the A321 family as even the XLR is not able to fulfill this mission with the usual 220 pax. In general, the effect of the considerable FC reduction surpasses the contributions from the  $C_{FUEL}$  and  $C_{ATC}$ , which lastly contributes to lower DOCs than in M1 and M2 for both methods and cases (a and b) – the A339 in the TUB method is still an exception to this observation due to the same factors explained previously.

The SKCs for the LR are not adequately comparable to the other aircraft since the passenger number differs considerably. Nevertheless, the values for the DOC vary minimally (less than 6%) when compared to the other missions with and without additional cargo – a clear trend cannot be indicated. With the TUB method, the SKCs for M3 are generally lower than M1 and M2, whereas, with the AEA method, M2 shows a slight advantage in the case of the XLR (the A339 is still more advantageous with M3).

**Table 4. 33** DOC comparison between the A321LR and similar aircraft: M3 – high-density cabin, with additional cargo

Method Aircraft (Configuration)	TU Berlin			AEA		
	A321LR(186)*	A321XLR(208)*	A330-9neo(420)	A321LR(186)*	A321XLR(208)*	A330-9neo(420)
DOC[M US\$/year]	35,12	37,15	77,58	61,74	64,67	128,26
CCAPITAL[M US\$/year]	8,37	8,45	21,23			
CHANDLING[M US\$/year]	1,26	1,41	3,33			
CLANDING[M US\$/year]	0,67	0,70	1,75			
CATC[M US\$/year]	5,02	5,12	8,24			
CCREW[M US\$/year]	3,29	3,66	5,12	2,90	3,19	4,33
CMaint[M US\$/year]	2,17	2,18	4,00	7,50	7,52	14,60
CFuel[M US\$/year]	14,35	15,63	33,90	10,02	10,91	23,72
CDepreciation[M US\$/year]				9,66	10,01	21,17
CInterest [M US\$/year]				7,95	8,24	17,42
CInsurance [M US\$/year]				0,68	0,70	1,48
CFees [M US\$/year]				23,03	24,10	45,53
Economical DOC Interpretation						
Aircraft trip costs [US\$/flight]	61.618	65.173	130.819	155.119	162.484	309.066
Aircraft mile costs [US\$/nm]	15,42	16,31	32,74	38,82	40,66	77,35
Aircraft kilometer costs [US\$/km]	8,33	8,81	17,68	20,96	21,96	41,77
Seat-mile costs [US\$/nm]	0,083	0,078	0,078	0,209	0,196	0,184
Seat kilometer costs [US\$/km]	0,045	0,042	0,042	0,113	0,106	0,099
Costs per flight hour [US\$/h]	7.083	7.491	15.761	17.885	18.734	37.288
Costs per block hour [US\$/h]	5.852	6.189	12.914	17.384	18.209	36.197

**Table 4. 34** DOC comparison between the A321LR and similar aircraft: M3 – high-density cabin, without add. cargo

Method Aircraft (Configuration)	TU Berlin			AEA		
	A321LR(186)*	A321XLR(208)*	A330-9neo(420)	A321LR(186)*	A321XLR(208)*	A330-9neo(420)
DOC[M US\$/year]	35,12	37,13	76,21	61,73	64,21	125,94
CCAPITAL[M US\$/year]	8,37	8,45	21,23			
CHANDLING[M US\$/year]	1,25	1,40	2,95			
CLANDING[M US\$/year]	0,67	0,70	1,75			
CATC[M US\$/year]	5,02	5,12	8,24			
CCREW[M US\$/year]	3,29	3,66	5,12	2,90	3,19	4,33
CMaint[M US\$/year]	2,17	2,18	4,00	7,50	7,48	14,60
CFuel[M US\$/year]	14,35	15,61	32,92	10,02	10,52	23,04
CDepreciation[M US\$/year]				9,66	10,01	21,17
CInterest [M US\$/year]				7,95	8,24	17,42
CInsurance [M US\$/year]				0,68	0,70	1,48
CFees [M US\$/year]				23,03	24,07	43,90
Economical DOC Interpretation						
Aircraft trip costs [US\$/flight]	61.614	65.135	128.522	155.110	161.341	303.465
Aircraft mile costs [US\$/nm]	15,42	16,30	32,17	38,82	40,38	75,95
Aircraft kilometer costs [US\$/km]	8,33	8,80	17,37	20,96	21,80	41,01
Seat-mile costs [US\$/nm]	0,083	0,078	0,077	0,209	0,194	0,181
Seat kilometer costs [US\$/km]	0,045	0,042	0,041	0,113	0,105	0,098
Costs per flight hour [US\$/h]	7.082	7.487	15.485	17.884	18.602	36.613
Costs per block hour [US\$/h]	5.851	6.186	12.687	17.383	18.081	35.541

Table 4.35 shows the results for M3 regarding a low-density cabin configuration and with additional cargo, whereas Table 4.36 shows the correspondent mission without additional cargo.

With a low-density cabin configuration and additional cargo, the DOCs for M3 are generally **lower** than those from M1 and M2 (exception: A339 with the TUB method). For missions without additional cargo, M3 reveals higher DOCs than M1 and M2, as for the TUB method. In the case of the AEA method, despite a smaller gap between the missions, M3 still shows lower DOCs.

With a low-density cabin configuration, the SKCs for M3 are in all cases, lower than the correspondent ones with M1 and M2. Furthermore, these costs are the lowest with the LR, followed by the XLR and then the A339.

**Table 4.35** DOC comparison between the A321LR and similar aircraft: M3 – low-density cabin, with additional cargo

Method	TU Berlin			AEA		
	A321LR(180)	A321XLR(180)	A330-9neo(340)	A321LR(180)	A321XLR(180)	A330-9neo(340)
DOC[M US\$/year]	35,12	36,78	76,84	61,67	64,19	127,69
CCAPITAL[M US\$/year]	8,37	8,45	21,23			
CHANDLING[M US\$/year]	1,26	1,41	3,33			
CLANDING[M US\$/year]	0,67	0,70	1,75			
CATC[M US\$/year]	5,02	5,12	8,24			
CCREW[M US\$/year]	3,29	3,29	4,39	2,90	2,90	3,76
CMANT[M US\$/year]	2,17	2,18	4,00	7,44	7,53	14,60
CFUEL[M US\$/year]	14,35	15,63	33,90	10,02	10,33	23,72
CDepreciation[M US\$/year]				9,66	10,01	21,17
Cinterest [M US\$/year]				7,95	8,24	17,42
Cinsurance [M US\$/year]				0,68	0,70	1,48
CFees [M US\$/year]				23,03	24,47	45,53
Economical DOC Interpretation						
Aircraft trip costs [US\$/flight]	61.618	64.530	129.584	154.955	161.281	307.683
Aircraft mile costs [US\$/nm]	15,42	16,15	32,43	38,78	40,36	77,00
Aircraft kilometer costs [US\$/km]	8,33	8,72	17,51	20,94	21,79	41,58
Seat-mile costs [US\$/nm]	0,086	0,090	0,095	0,215	0,225	0,226
Seat kilometer costs [US\$/km]	0,046	0,048	0,052	0,116	0,121	0,122
Costs per flight hour [US\$/h]	7.083	7.417	15.613	17.866	18.595	37.122
Costs per block hour [US\$/h]	5.852	6.128	12.792	17.365	18.074	36.035

**Table 4 36** DOC comparison between the A321LR and similar aircraft: M3 – low-density cabin, without add. cargo

Method	TU Berlin			AEA		
	A321LR(180)	A321XLR(180)	A330-9neo(340)	A321LR(180)	A321XLR(180)	A330-9neo(340)
DOC[M US\$/year]	34,96	35,99	73,47	61,48	62,26	121,93
CCAPITAL[M US\$/year]	8,37	8,45	21,23			
CHANDLING[M US\$/year]	1,21	1,21	2,39			
CLANDING[M US\$/year]	0,67	0,70	1,75			
CATC[M US\$/year]	5,02	5,12	8,24			
CCREW[M US\$/year]	3,29	3,29	4,39	2,90	2,90	3,76
CMAINT[M US\$/year]	2,17	2,18	4,00	7,50	7,53	14,60
CFUEL[M US\$/year]	14,23	15,03	31,47	9,94	9,61	22,02
CDepreciation[M US\$/year]				9,66	10,01	21,17
CInterest [M US\$/year]				7,95	8,24	17,42
CInsurance [M US\$/year]				0,68	0,70	1,48
CFees [M US\$/year]				22,86	23,26	41,48
Economical DOC Interpretation						
Aircraft trip costs [US\$/ flight]	61.334	63.141	123.898	154.468	156.431	293.818
Aircraft mile costs [US\$/ nm]	15,35	15,80	31,01	38,66	39,15	73,53
Aircraft kilometer costs [US\$/ km]	8,29	8,53	16,74	20,87	21,14	39,71
Seat-mile costs [US\$/ nm]	0,085	0,088	0,091	0,215	0,217	0,216
Seat kilometer costs [US\$/ km]	0,046	0,047	0,049	0,116	0,117	0,117
Costs per flight hour [US\$/ h]	7.050	7.258	14.928	17.810	18.036	35.449
Costs per block hour [US\$/ h]	5.825	5.996	12.231	17.311	17.531	34.411

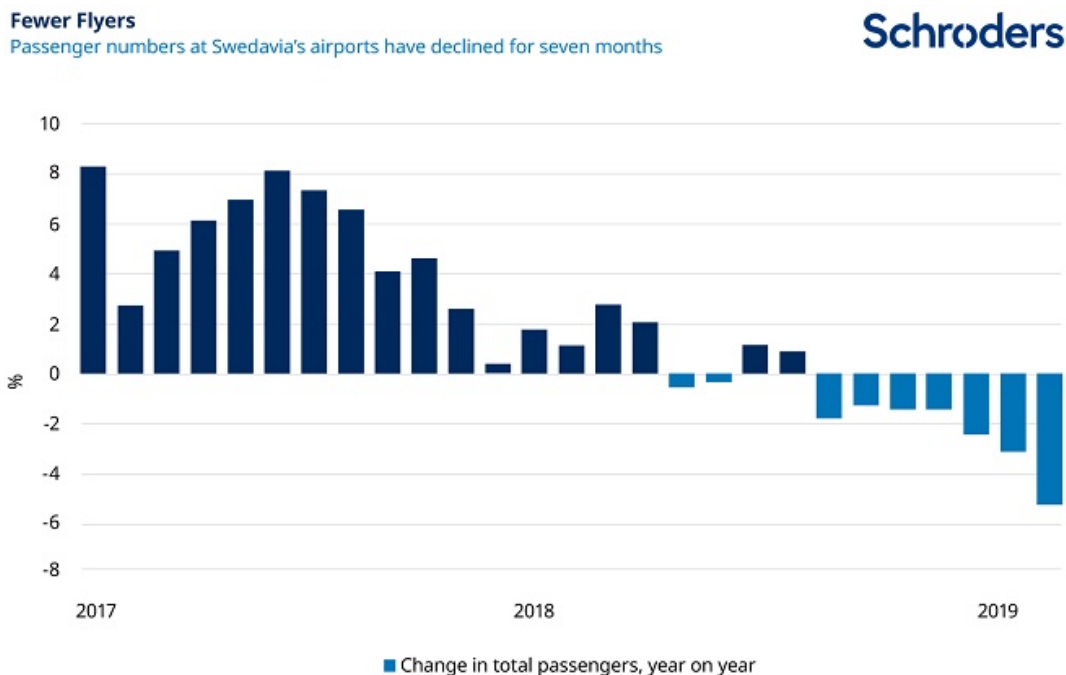


## 5 Ecolabel Applied to the Airbus A321LR

### 5.1 Introduction, History, and Launch of the Ecolabel

Another relevant aspect of an aircraft's operation is the assessment of its inherent overall environmental impact. With the evident and increasing climate changes, the side-effects of flying are receiving special attention and should therefore be evaluated more thoroughly. On the other hand, the general environmental concerns became more relevant since the ecologic conscience of the passengers is maturing. For example, the phenomenon of "Flygskam" (Swedish for flight-shame) is receiving more and more support, as climate activists like Greta Thunberg are pleading for an eco-friendlier world, especially regarding transport, industries, and services. Since the establishment of this movement in 2017, the number of passengers in the world's ten busiest airports had dropped by 5% in 2019 compared to the previous year. In Germany, the number of people flying domestically even dropped by 12% as of November 2019 (Farmbrough 2019).

Figure 5.1 shows the development of the number of passengers registered from 2017 to 2019 by Swedavia, which owns and operates Sweden's ten busiest airports.



**Figure 5.1** Passenger number development registered by Swedavia between 2017 and 2019 (Hervey-Bathurst 2019)

Nevertheless, from a practical point of view, passenger-driven aviation is still necessary since it shortens the distance between continents by bringing relatives and friends together, as well as allowing people to visit distant places for leisure.

With this in mind, the role of aeronautical engineers is crucial when intending to reduce the environmental burden, which can be done by employing not only more sustainable fuel but also more efficient and sustainable methods for planning, designing, regulation, and lastly, operation of aircraft. The symbiosis of these factors specifically aims a lower fuel consumption as well as fewer emissions. Another positive side-effect of these efforts is the stimulation of new technologies.

For this matter, the logical step is to implement a system that allows classifying aircraft in terms of their environmental burden or, in other words, in compliance with the environmental standards imposed. The implementation of a systematic Ecolabel for passenger aircraft represents a suitable solution. This label should provide information about the environmental impact and energy efficiency of passenger aircraft.

Both aircraft manufacturers and airlines constantly advertise new aircraft by stating that these handle the environmental impact better than the previous generation. Statements regarding better engines with reduced emissions as well as improved cabins and cabin configurations are not uncommon.

On the other hand, there is still no standardized and scientifically sustained way of verifying and accessing these statements, especially between different aircraft and generations. In 2017 the Hamburg University of Applied Sciences (HAW Hamburg) started developing an ecolabel for passenger aircraft (Scholz 2020), based in the ecolabel designed by the airline Flybe (Massy-Beresford 2007). This ecolabel has been since then improved by different students in the context of various projects and theses. EASA itself started developing its method in 2019, which is, as of today, not fully implemented (Scholz 2020).

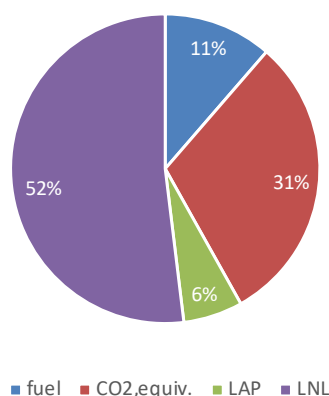
In the context of the Hamburg Aerospace Lecture Series, Scholz summarized the concept developed so far in the presentation “*Ecolabel for Aircraft – Definition, and Application*” (Scholz 2020). Here, a sequence of measures is stated, which would reduce the environmental burden of flying, according to their priority:

- avoid traveling
- for each trip, select the best mode of transportation (aircraft, train, bus)
- select the shortest route
- select the best aircraft-airline-combination (based on Ecolabel)
- select an economy seat
- compensate

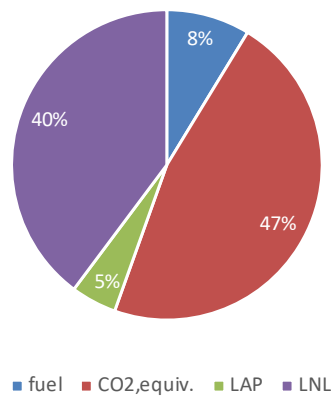
In 2021, this ecolabel was thoroughly revised and finally launched with a verifiable systematic in the Master Thesis “*Launch of an Ecolabel for Passenger Aircraft*” by Hurtecant (2021).

This Ecolabel for Aircraft consists of analyzing the **resource depletion**, **global warming** contributions, **local air quality**, and finally **noise pollution** resulting from the aircraft's operation. These factors are recognized as the main negative effects of aviation on the environment.

The emissions of each impact category were normalized against a group of reference aircraft that account for over 95% of the passenger aircraft flying at the time. Based on the results from a life cycle assessment (LCA), the impact categories are then weighted 20%, 40%, 20%, and 20%, respectively – see Figures 5.2 and 5.3. The four impact categories are then combined into an overall rating. Seating arrangements in different travel classes are considered based on the cabin floor area occupied by each passenger.



**Figure 5.2** Ecolabel: exemplary distribution of the impact categories – unweighted



**Figure 5.3** Ecolabel: exemplary distribution of the impact categories – weighted

The first impact category, resource depletion, mainly translates into the fuel consumption that occurs during the aircraft's operation and is expressed in kilograms of fuel per flown kilometer and seat. Since different airlines employ different seating configurations and classes, a distinction on the fuel consumption per class can be made.

The global warming contributions address the equivalent carbon dioxide (CO<sub>2</sub>) emissions, including the altitude-dependent nitrogen oxides (NO<sub>x</sub>), as well as aviation-induced cloudiness. According to FAA (2015, see Appendix I), carbon dioxide is the product of the complete combustion of hydrocarbon fuels (kerosene). Carbon in fuel combines with oxygen in the air to produce CO<sub>2</sub>. The main emission source of this substance in the aircraft is the engines and the auxiliary power unit (APU). CO<sub>2</sub> accelerates climate change. Nitrogen oxides are produced when air passes through high temperature and/or high-pressure combustion, and nitrogen and oxygen present in the air combine to form NO<sub>x</sub>. This contributes to ozone and secondary particulate matter formation, which worsen the air quality and accelerate climate change as well.

*Particulate Matter: “Small particles of soot that form as a result of incomplete combustion and aerosols from condensed gases, which are small enough to be inhaled” (FAA 2015).*

The local air quality or local air pollution (LAP) focuses on human health in the vicinity of airports, as well as the general effects on flora and fauna caused by the emissions (EASA 2019). The main danger is the inhalation of small particles and ozone, which are by-products of fuel combustion.

Further, environmental noise pollution is defined by Murphy (2014) as:

*“...any unwanted sound created by human activities that is considered harmful or detrimental to human health and quality of life. Specifically, environmental noise refers only to noise affecting humans and is concerned exclusively with outdoor sound caused generally by transport, industry, and recreational activities. Thus, environmental noise is a form of pollution.”*

Aircraft noise is often considered a noise pollutant and is, of course, especially an issue in airports and surrounding areas. According to the World Health Organization (WHO 2021),

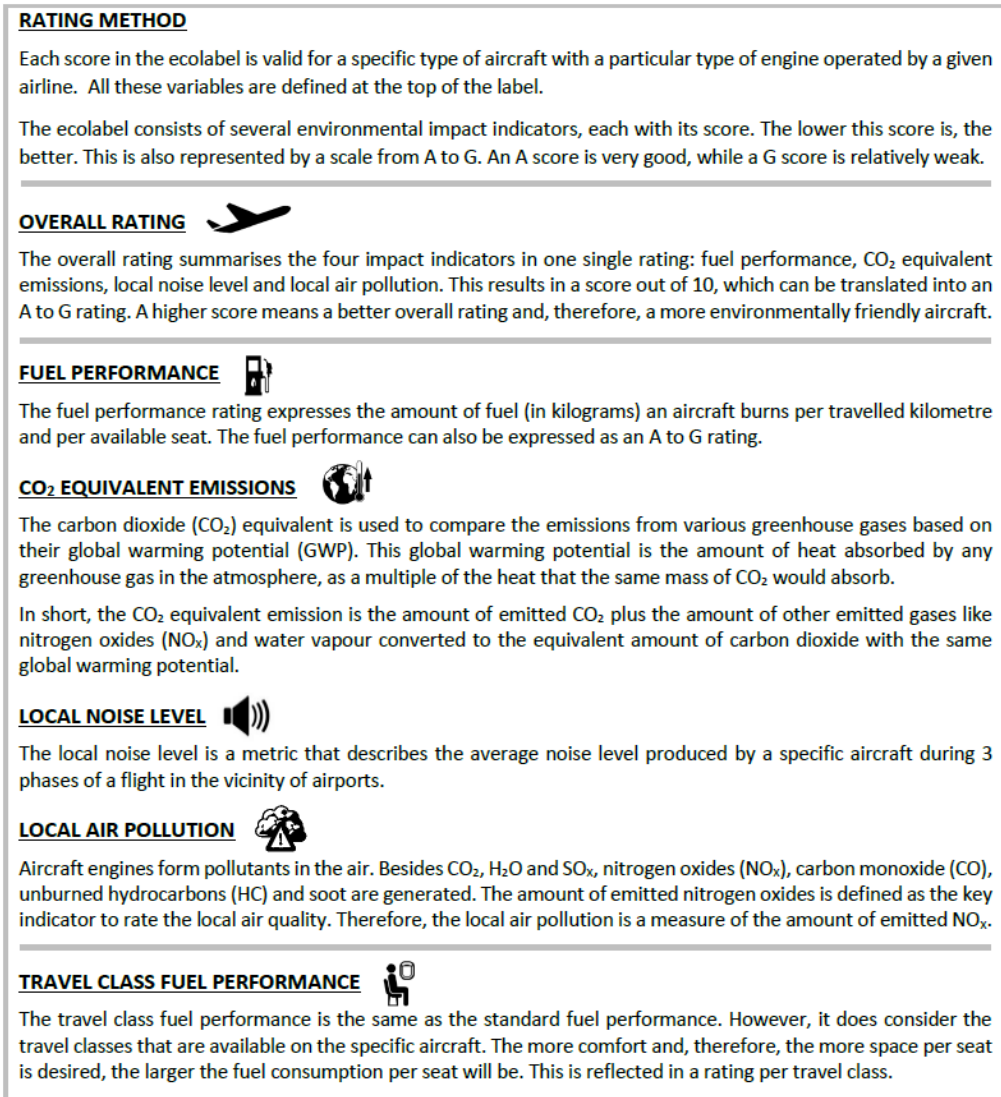
*“excessive noise seriously harms human health and interferes with people’s daily activities at school, at work, at home, and during leisure time. It can disturb sleep, cause cardiovascular and psychophysiological effects, reduce performance, and provoke annoyance responses and changes in social behavior”.*

The noise produced by aircraft is measured in terms of the Effective Perceived Noise Level (EPNL) and expressed in units of Effective Perceived Noise in Decibels (EPNdB), which is defined by Depitre (2006) as:

*“... measure of human annoyance to aircraft noise which has special spectral characteristics and persistence of sounds. It accounts for human response to spectral shape, intensity, tonal content, and duration of noise from an aircraft”.*

In the master thesis of Hurtecant, over 140 ecolabels were calculated, and the usefulness of the concept was proven, as it made it possible to compare different airlines in terms of the cabin configurations employed – for example, for the same aircraft type. Hurtecant affirms that “Airlines that operate a modern fleet, have tight seating in a single (economy) class, and are known for their high load factor, are better for the environment.” Furthermore, he states that “the ecolabel gives a foundation for a general discussion about different travel options based on neutral scientific methods and data” (Hurtecant 2021).

Figure 5.2 shows a resulting flyer from the master thesis, which intends to make the Ecolabel understandable for passengers.



**Figure 5.4** Flyer explaining the Ecolabel to the general public or passengers (Hurtecant 2021)

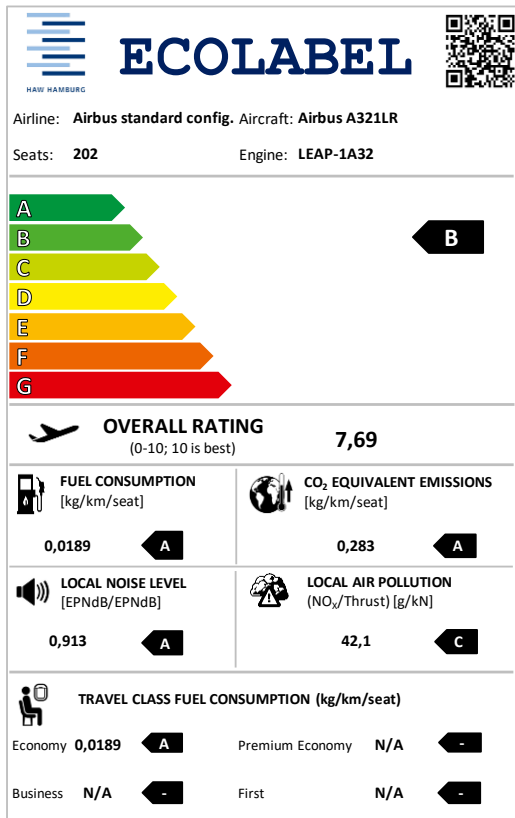
## 5.2 Ecolabel Assessment of the A321 LR

As stated previously, the Airbus A321LR is a recent aircraft that completed its first flight in 2018, so that the general environmental impact of this aircraft is not entirely investigated. JetBlue, one of the aircraft's most recent operators, states that: "... *the aircraft delivers 30% fuel savings and nearly 50% reduction in noise footprint compared to previous generations of aircraft*" (Business Wire 2021).

The results regarding fuel consumption presented in Chapter 3 can substantiate this affirmation to a certain extent. Therefore, the application of the Ecolabel for Aircraft on this aircraft intends to assess the LR's overall environmental impact and abet its further investigation.

**Note:** all Ecolabels were generated with the help of the tool launched by Hurtecant (2021). Therefore it is waived to reference the tool in each of the Figures 5.2 to 5.11.

Figure 5.2 shows the resulting ecolabel for the A321LR with the Airbus standard cabin configuration.



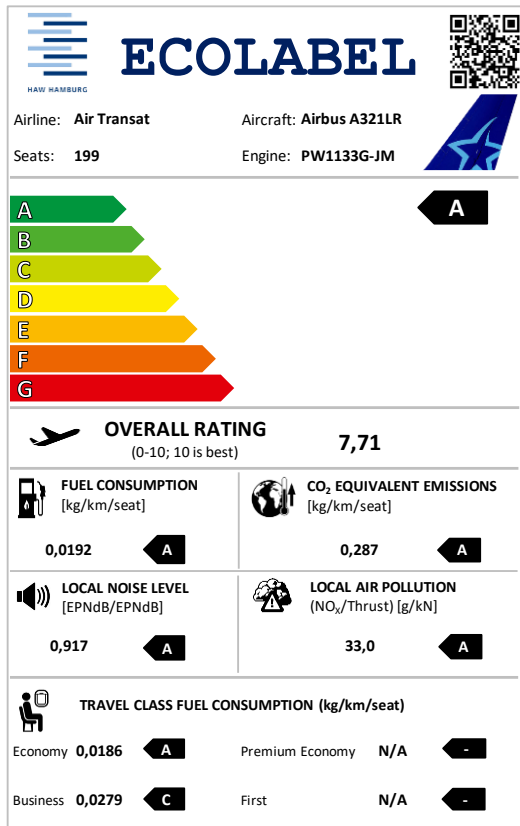
**Figure 5.5** Ecolabel for the Airbus A321LR: Airbus standard configuration

The Airbus standard configuration for the A321LR assumes a cabin configuration of 202 seated pax (standard density) with a 32" (inch) seat pitch and 18" seat width while employing two CFM LEAP-1A32 engines (Airbus 2020). This cabin configuration is then considered to be exclusively in economy class, and therefore, the fuel consumption is equal for every passenger and class.

Except for the Local Air Pollution (C-Rating), all the rating categories score an A-Rating. According to this Ecolabel, the LR consumes 0,0189 kg per km and pax, which translates into an equivalent of 0,283 kg per km and pax. The local air pollution of the engines, measured in nitrogen oxide emissions, is ascertained at 42,1 g per kN of thrust. The local noise level is 0,913 EPNdB/EPNdB.

Lastly, the present Aircraft and configuration receive an Overall Rating of **B** while scoring 7,69 out of 10 possible points.

Figure 5.4 shows the Ecolabel for the LR with the cabin configuration employed by Air Transat



**Figure 5.6** Ecolabel for the Airbus A321LR: Air Transat

The Canadian airline Air Transat belongs to the group of operators of the A321LR and employs this aircraft mainly in Routes that connect the Canadian metropolises Toronto and Montreal with Basel, Paris, and London (Eiselin 2021). According to (SeatGuru 2021a), this airline flies the LR with a total of 199 passengers in the following configuration:

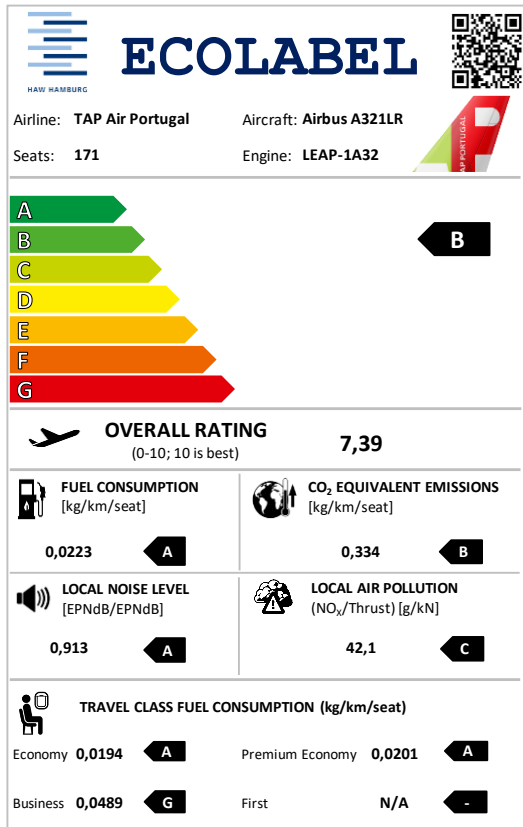
- 187 pax in Economy Class with 31” seat pitch and 18” seat width
- 12 pax in Business Class with 38” seat pitch and 22” seat width
- Pratt & Whitney PW1133G-JM engines

The Pratt & Whitney engines show relatively significant improvements in terms of Local Air Pollution (A-Rating) while performing slightly worse in the other categories – the number of Passengers is comparable to the Airbus standard. The Local Noise Level falls into a B-Rating.

With the present airline and cabin configuration, the A321LR receives an Overall Rating of **A** by scoring 7,71 out of 10 possible points. In the end, this configuration even outperforms the Airbus standard configuration by 0,02 points, despite having three passengers less (more consumption). The slight decreases in the other performance categories are compensated by the

improved local air pollution, which has significant relevance in the overall performance (A-Rating).

Figure 5.5 shows the Ecolabel for the LR with the cabin configuration employed by TAP Air Portugal.



**Figure 5.7** Ecolabel for the Airbus A321LR: TAP Air Portugal

The Portuguese airline TAP Air Portugal operates the A321LR mainly in routes that connect the Portuguese capital Lisbon with cities on the east coast of the North American continent (New York, Boston, and Montreal) as well as with some Brazilian metropolises (Recife, Fortaleza, and Salvador) (Weltreisender 2021). According to SeatGuru (2021b), this airline flies the LR with 171 passengers in the following configuration:

- 
- 113 pax in Economy Class with 31” seat pitch and 17,7” seat width
- 42 pax in Premium Economy Class with 32” seat pitch and 17,7” seat width
- 16 pax in Business Class with 62” (mean) seat pitch and 22,3 seat width
- CFM LEAP-1A32 engines

The Local Air Pollution and Noise Level show the same values as the Airbus standard configuration due to the common engines. On the other hand, the effects of the pax reduction are evident since the Fuel Consumption per km and pax and the correspondent CO<sub>2</sub> Equivalent

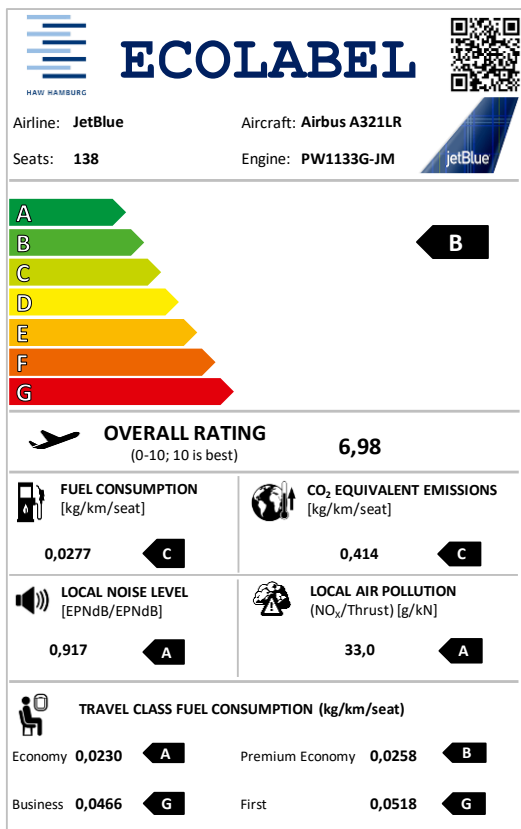


Emissions rise by around 18%. Thus, while the Fuel Consumption keeps the A-Rating, the CO<sub>2</sub> emissions receive a B-Rating.

Both the Economy and the Premium Economy Classes show partial A-Ratings in terms of Fuel Consumption. At the same time, the Business Class consumes around three times more fuel and thus a correspondent G-Rating.

With the present airline and cabin configuration, the A321LR receives an Overall Rating of **B** by scoring 7,39 out of 10 possible points (3,9% less than Airbus standard configuration).

Figure 5.6 shows the Ecolabel for the LR with the cabin configuration employed by JetBlue.



**Figure 5.8** Ecolabel for the Airbus A321LR: JetBlue

Finally, the American airline JetBlue is set to operate the A321LR mainly in Routes between New York, Boston, and London, so the airliner (JetBlue 2021a). According to JetBlue's (2021b) official website, this airline flies the LR with 138 passengers in the following configuration:

- 
- 90 pax in Economy Class with 33" seat pitch and 17,8" seat width
- 24 pax in Premium Economy Class with 37" seat pitch and 17,8" seat width
- 22 pax in Business Class with 58" seat pitch and 20,5" seat
- 2 pax in First Class with 60" seat pitch and 22" seat

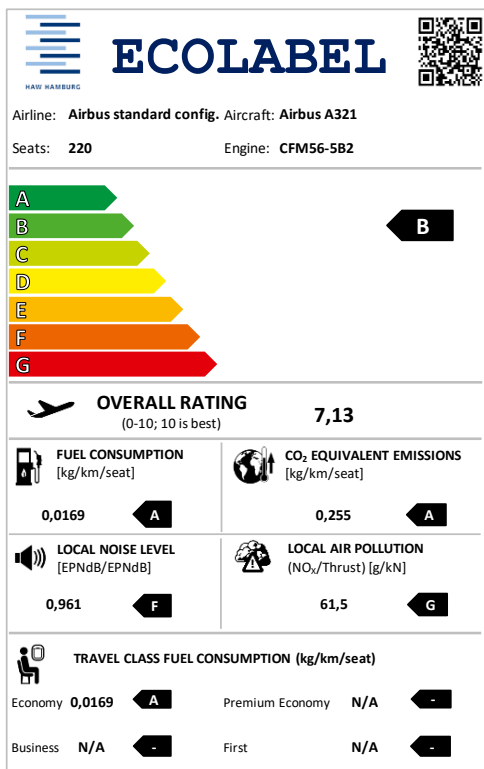
- Pratt & Whitney PW1133G-JM engines

This configuration has the lowest number of passengers. Thus, the Fuel Consumption per kilometer and seat increases drastically in relation to the airbus standard configuration. Especially the upper seat classes (G-Rating) contribute to the so-far lowest score in terms of Fuel Consumption – C-Rating. The equivalent CO<sub>2</sub> emissions vary accordingly, also with a C-Rating. By using the PW engines, the same observations stated in the case of Air Transat are here once more confirmed regarding the Local Noise Level and Local Air Pollution.

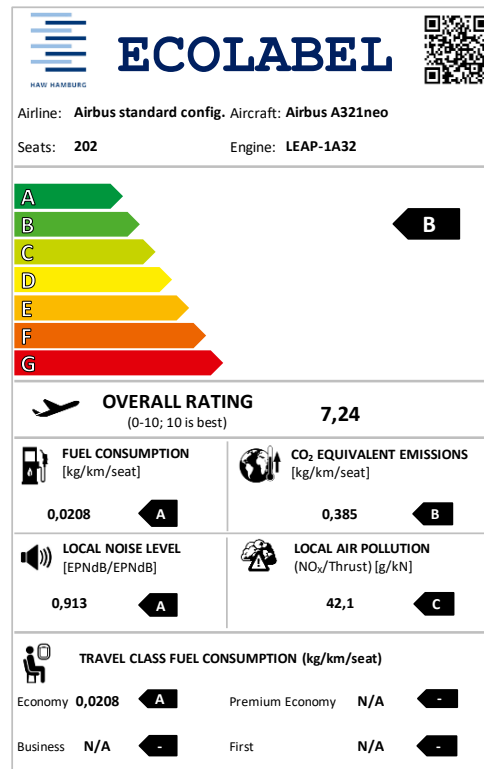
With the present airline and cabin configuration, the A321LR receives an Overall Rating of **B** by scoring 6,98 out of 10 possible points (9,2% less than Airbus standard configuration).

### 5.3 Ecolabel Assessment of the Other Aircraft Used for Comparison

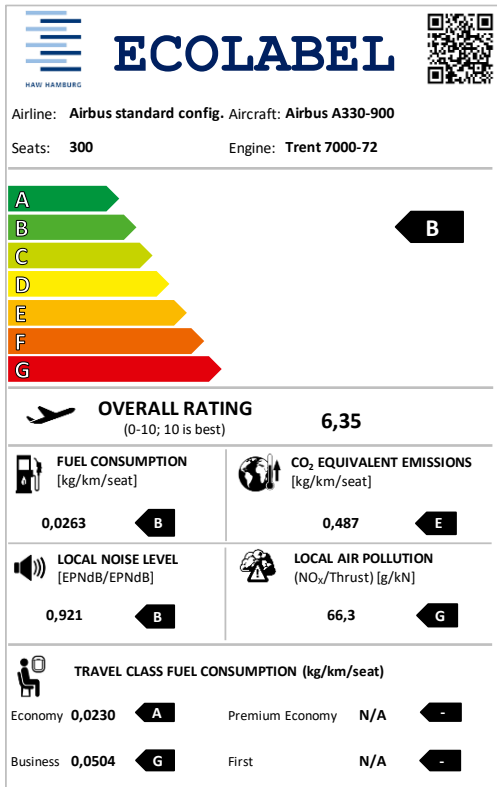
For comparative purposes, the Ecolabel for the (existing) similar aircraft referred so far and concerning the manufacturer’s standard configuration was produced. Therefore, the results are shown in the upcoming Figures 5.6 to 5.8, without further comment. Further Ecolabels for other A321LR operators can be found in Appendix J.



**Figure 5.9** Ecolabel for the A321ceo: Airbus std. configuration



**Figure 5.10** Ecolabel for the A321neo: Airbus std. configuration



**Figure 5.11** Ecolabel for the A330-900neo: Airbus standard configuration

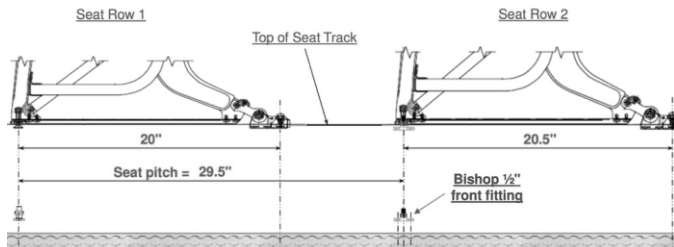
## 6 Cabin Layout of the Airbus A321LR

### 6.1 Introduction and General Considerations

Aircraft cabins offer great flexibility and are therefore primarily configured accordingly to the operator's needs, which will generally vary with time. Amongst others, the differences in configuration englobe, the number, dimensions, and orientation of monuments like galleys, WCs, overhead space compartments (OHSCs), and seats.

As seen throughout this thesis, the number of passenger seats has a major impact not only on the fuel consumption and in the DOCs but also on the environmental impact of the aircraft's mission as well. For this matter, the replacement of passenger seats should not demand high effort nor take a long time. Line replaceable units (LRUs) like seats and other monuments are therefore fastened to the seat rails (seat tracks) on the cabin floor (see Figure 6.1) for a safe and secure attachment. Figure 6.2 illustrates a passenger aircraft cabin in which all seat rows have been removed.

*“Line Replaceable Units (LRU) are modular components and usually sealed units of an aircraft, which are designed to be replaced within a short time without using very specialized tools. This means that the aircraft can quickly return to service...” (Satair 2020)*



**Figure 6.1** Installation of seat rows in the seat rails, example (Walton 2016)



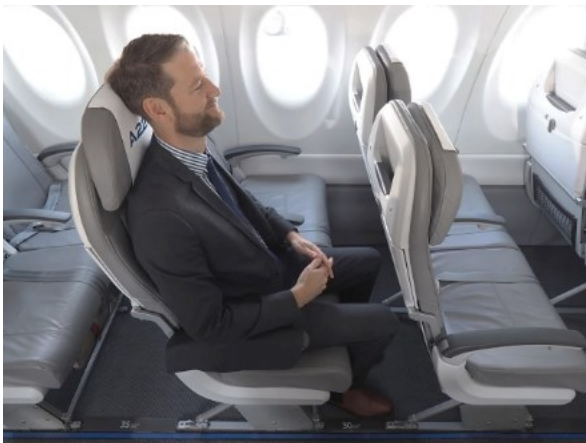
**Figure 6.2** Passenger aircraft cabin with removed seats (Andrew 2020)

## 6.2 Seat Pitch versus Ergonomic Assessment of the Cabin Layouts Employed by the A321LR Operators

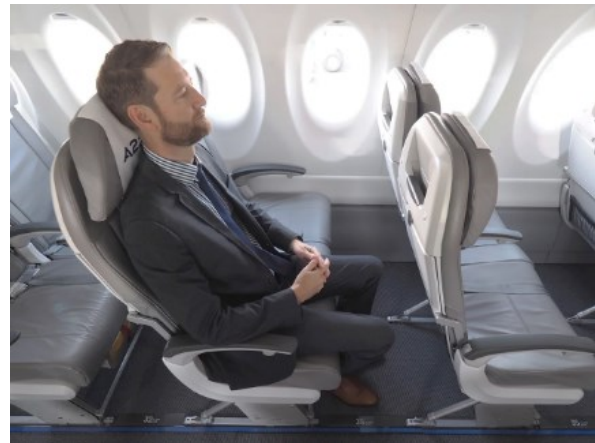
Not only is it possible to remove or add seat rows, but it is also possible to increase or decrease the spacing between the rows – the seat pitch. According to SeatGuru (2021c), seat pitch is:

*“... the distance from any point on one seat to the exact same point on the seat in front or behind it. While it is not the exact equivalent of “legroom,” it does give a very good approximation of how much seat room you should expect.”*

The seat pitch directly influences the legroom of the seating passenger, and it determines how much clearance there is towards the backrest of the front seat. Figures 6.3 and 6.4 illustrate the contrasts between a larger and a narrower seat pitch.



**Figure 6.3** Seat pitch 31” (Honig 2018)



**Figure 6.4** Seat pitch 34” (Honig 2018)

It is evident that a larger seat pitch allows more legroom and thus contributes to a better body posture and comfort, mainly because it avoids having to bend the knees excessively. By employing this kind of seat pitch, the seats demand more cabin surface, which, lastly, results in fewer seat rows. On the other side, a narrower seat pitch allows more seating rows, but the passengers tend to sit in less natural positions, which get especially uncomfortable during long flights.

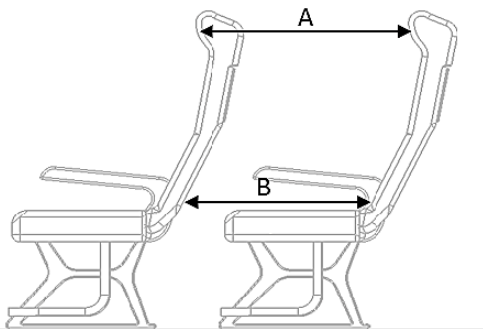
Therefore, the choice of an adequate seat pitch should follow ergonomic guidelines, as these affect the well-being (comfort) of the passenger. Nevertheless, these measurements vary according to gender, age, and demography. For example, male passengers are normally taller than females, and adults are taller than children. In the same way, the average height of the

USA population is generally greater than the population of Japan, for example. To address this, anthropometric percentiles are employed in a sensible manner when designing the aircraft cabin. According to OpenErg (2021):

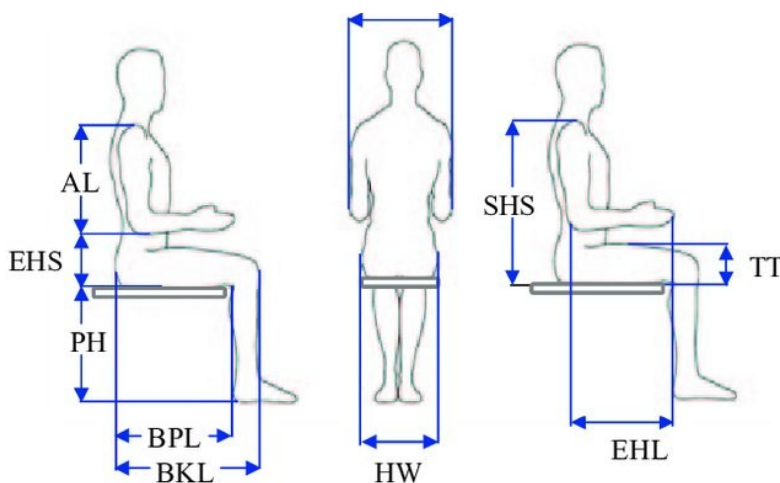
*“The percentage of people who are smaller than a given size is called a percentile.”*

By doing this, there is a statistical guarantee that the majority of the passengers will be satisfied with the cabin configuration. In aviation, the most used percentiles are the “95% man” and the “5% woman”. By employing this, there is the guarantee that at least 90% of the population will be covered. On the other hand, very tall and very short people will probably not be completely satisfied.

The seat pitch includes the seat length, the thickness of the backrest, and the clearance towards the next seat (see Figure 6.5). Some of the relevant measurements that define the seat length are, amongst others, the seating knee height, the buttock-popliteal length (BPL), and the buttock-knee length (BKL) – see Figure 6.6. The seat length normally takes the “95% man” into account, and by doing this, very short people will probably not be able to rest their feet on the cabin floor. Furthermore, the seat pitch also affects the freedom of the passenger while standing or walking towards the designated seat.



**Figure 6.5** Seat pitch (A) and legroom (B) (Kremser et al. 2012) – The clearance at knee height is equal to the legroom minus the BKL.



**Figure 6.6** Anthropometric measurements while seating (Gosende 2017)

According to SeatMaestro (2021a), most seat pitches in economy class range from 29” to 34”, so that the legroom will also vary depending on the passenger. Table 6.1 shows the estimated legroom and the clearance at knee height based on anthropometric data from the Ergocenter of the North Carolina State University (Ergocenter NCSU 2006) – BKL for the “95% American male” and “5% American female” (see Appendix K). An average backrest thickness of around 80 mm or 3,14” is estimated.

**Table 6.1** Legroom for the considered percentiles: 29” and 34” seat pitch

Percentile	5% american female		95% american male	
Backrest	estimated at 3,14" (80 mm)			
BKL	21,3" (542,1 mm)		26,3" (667,4 mm)	
Seat pitch	29" 737 mm	34" 864 mm	29" 737 mm	34" 864 mm
Legroom	25,9" 657 mm	30,9" 784 mm	25,9" 657 mm	30,9" 784 mm
Clearance (at knee height)	4,51" 114,5 mm	9,51" 241,5 mm	- -	4,57" 116,2 mm

In both cases, narrow and large-seat pitch, there is enough clearance at knee height for the “5% female”, as the seat length is designed taking the BPL of the “95% male” into account. In the case of the narrower 29” seat pitch, it strikes that there would be no space between the kneecap and the backrest of the forward seat for the “95% male”. Furthermore, the clearance existing with the larger seat pitch is almost the same as the one from the “5% female” with the narrow seat pitch.

### 6.3 Seat Width and General Impact of the Cabin Layouts

Between different cabin classes, not only the seat pitch but also the sort of seat itself varies. For example, business class (B/C) seats are generally wider and more comfortable than economy seats and are therefore offered at higher fares. Furthermore, the wider the seats, the fewer seats abreast can be installed or the narrower the cabin aisle is. Figures 6.7 and 6.8 exemplify these differences based on different passenger seats employed by JetBlue.



**Figure 6.7** JetBlue Mint Studio – business class (JetBlue 2021b)



**Figure 6.8** JetBlue coach seats – economy class (JetBlue 2021b)

Table 6.2 shows a list of Airbus A321LR operators with their respective cabin configurations, seat pitch, and seat width.

**Table 6.2** Cabin configuration, seat pitch, and seat width for different airlines (measurements in inch) – (Airbus 2020; SeatGuru 2021a, 2021d, 2021b; Air Astana 2021 and JetBlue 2021b)

Airline	Total PAX	Economy Class			Premium Economy Class			Business Class			First Class		
		Seat Pitch	Seat Width	PAX	Seat Pitch	Seat Width	PAX	Seat Pitch	Seat Width	PAX	Seat Pitch	Seat Width	PAX
Airbus std.	202	32	18	202	0	0	0	0	0	0	0	0	0
Air Transat	199	31	18	187	0	0	0	38	22	12	0	0	0
Aer Lingus	184	31	18	168	0	0	0	61,5	20	16	0	0	0
TAP Portugal	171	31	17,7	113	32	17,7	42	62	22,3	16	0	0	0
Air Astana	166	30	20,5	150	0	0	0	45	28,5	16	0	0	0
JetBlue	138	33	17,8	90	37	17,8	24	58	20,5	22	60	22	2



It strikes that each configuration differs from the other, not only in terms of the total number of passengers but also in the seat pitch and width. For the economy class, a seat width of 18” is almost standard. The only exception to this is Air Astana (2021), which generally employs wider seats in the whole cabin and has, therefore, narrower aisles. The aircraft that offer a premium economy class, i.e., TAP Air Portugal and JetBlue, justify this by increasing the seat pitch and consequently the legroom compared to the economy class. The passenger seats remain, though.

Furthermore, the business class offers a mean of at least 4” added seat width and from 15” to 30” added seat pitch in comparison to the economy class (Y/C) – except for Air Transat. JetBlue is the only airline that offers first-class (F/C) seats – reclinable and improved versions of the Mint Studio shown in Figure 6.7 (JetBlue 2021b). Nevertheless, these seats still have a lower seat pitch than the TAP Air Portugal business class.

The standard configuration suggested by airbus allows transporting the largest number of passengers. Even though this configuration shows the second highest seat, this is still possible because of the single class (Y/C) configuration, which does not require class dividers (see Figure 6.8). An example of the tradeoff between less seat pitch and “more space” is shown by Air Transat: by reducing the seat pitch by 1”, it was possible to install twelve business class seats at the cost of only fifteen Y/C seats. Nevertheless, 38” is still a rather uncommon seat pitch for the B/C.

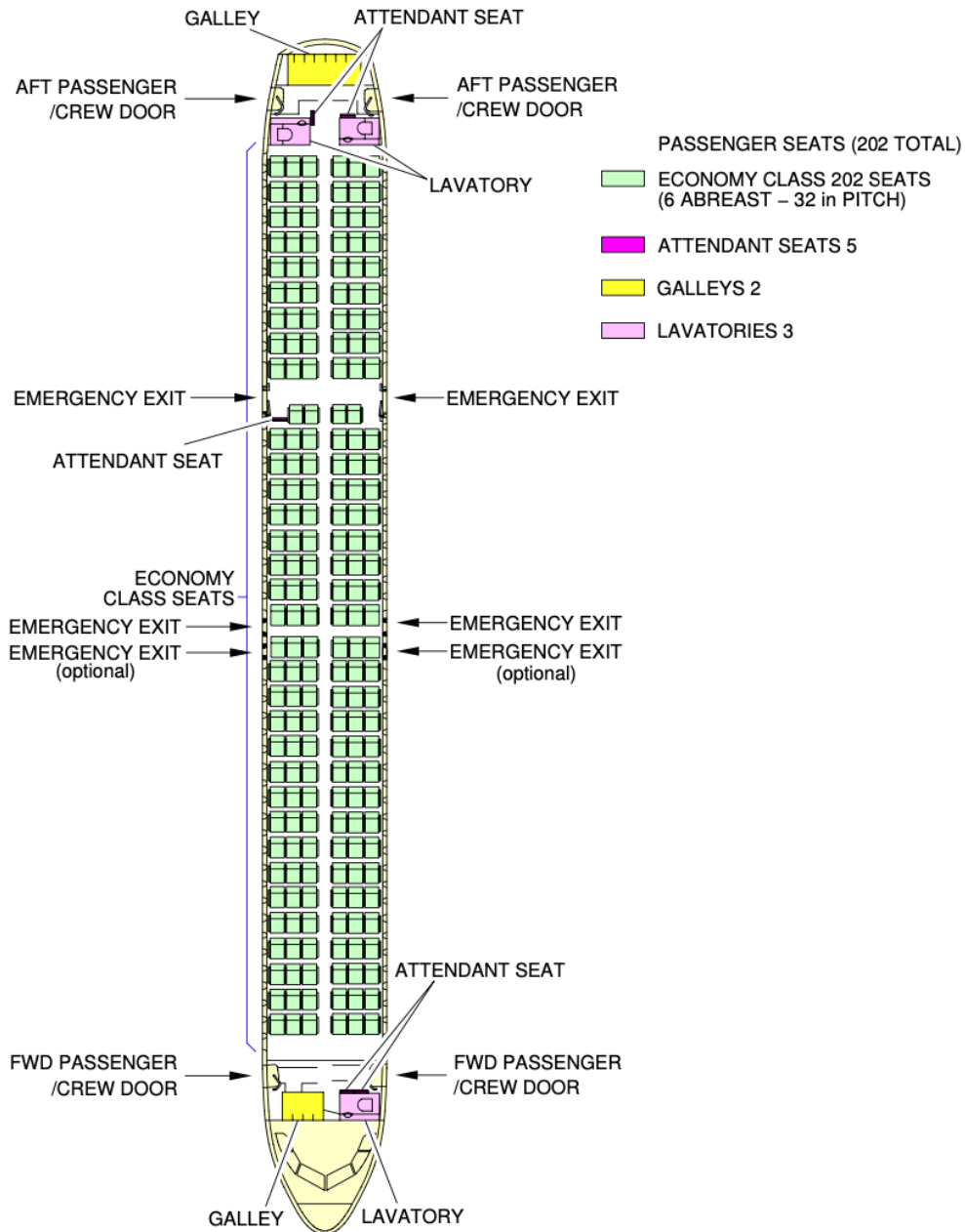
Furthermore, it strikes that the cabin configuration of JetBlue is only capable of transporting a total of 138 passengers, which is a reduction of around 32% percent towards the Airbus standard configuration.

## **6.4 Exemplary Seat Layouts for the A321LR: Airbus vs. Airlines**

Figures 6.9 and 6.10 present the seat layouts regarding the airbus standard configuration from Airbus (2020) and TAP Air Portugal (SeatGuru 2021b), respectively. Figure 6.11 shows, for JetBlue (SeatMaestro 2021b), the cabin configuration for an A321neo, as the corresponding layout for the LR is not yet available – except for the total number of seats, the layout is mostly the same.

It becomes evident that the cabin layouts vary not only in the number of seats but also in the number and configurations of the different monuments (lavatories and galleys) and that it is specific to the airlines’ needs. Aside from the larger seat pitch, the layouts contemplate exclusive galleys and lavatories as well as wider cabin aisles for the upper seating classes. Due to the larger number of seats, the cabin layout of TAP Air Portugal provides a total of four

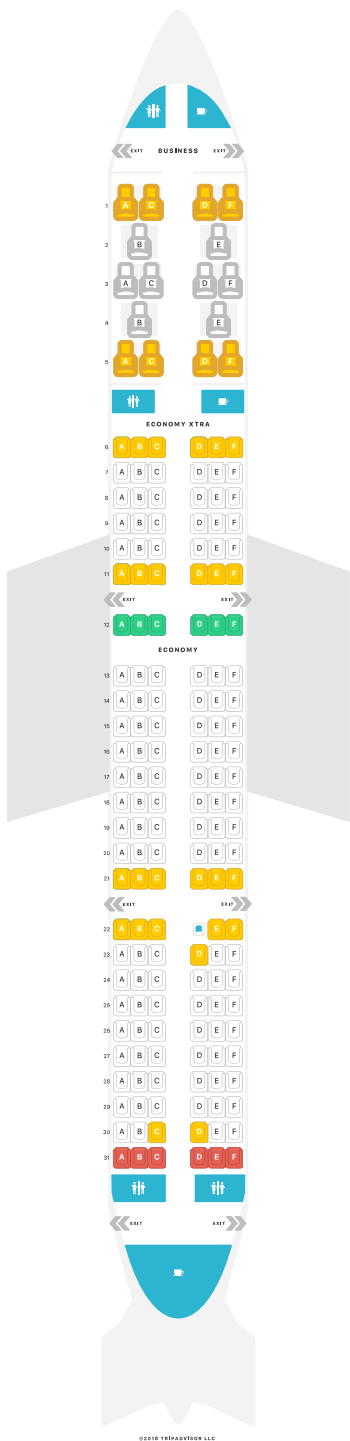
lavatories and three galleys, whereas JetBlue provides three lavatories and two galleys. These decisions are taken in order to avoid congestion in the aisles and allow rapid access to a nearby lavatory. This is the reason why TAP Air Portugal employs an extra lavatory and galley in the middle of the cabin. In the case of the Airbus standard cabin configuration, the single class configuration can be seen, with a ratio of 67 passengers per lavatory, which is likely sub-optimal.



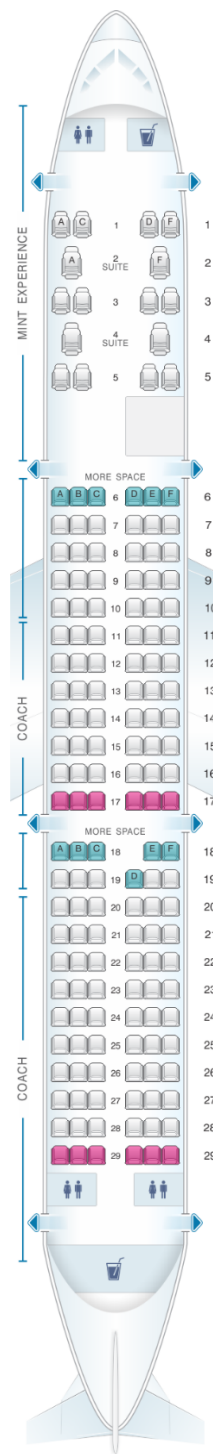
N\_AC\_020401\_1\_0110101\_01\_00

Interior Arrangements - Plan View for A321NEO-ACF  
 Typical Configuration - Single-Class, Standard  
 FIGURE-2-4-1-991-011-A01

**Figure 6.9** Seat layout of A321LR: Airbus standard configuration, single class (Airbus 2020)



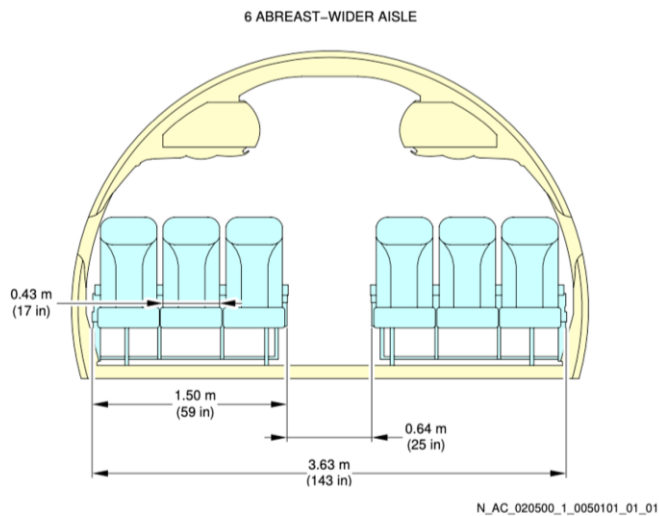
**Figure 6.10** Seat layout for the A321LR: TAP Portugal (SeatGuru 2021b)



**Figure 6.11** Seat Layout for A321neo+ JetBlue (SeatMaestro 2021b)

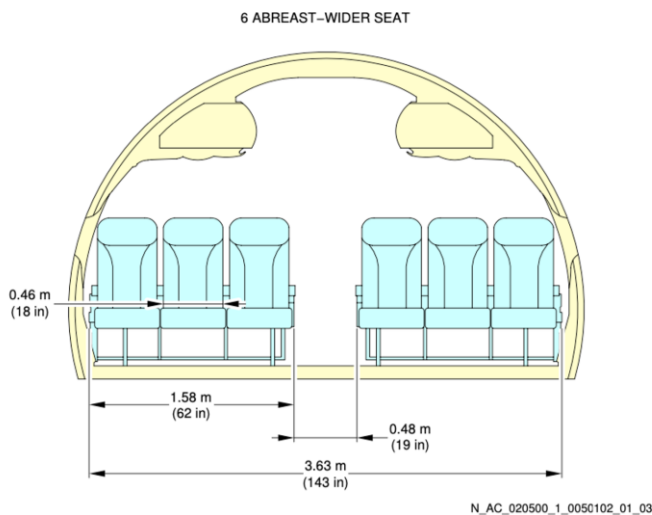
## 6.5 Cross Section and Aisle Configurations of the A321LR According to Airbus

Figures 6.12 to 6.14 present different cross-sections for the A321LR depending on the type and width of the seats employed (Airbus 2020). These different configurations, lastly, affect the width of the cabin aisle. By using wider seats, the passengers should sit more comfortably, but the cabin aisle width gets narrower. On the other hand, narrower seats allow a wider cabin aisle. Furthermore, first-class and business-class seats are generally much wider than economy seats, so that the cross-section layout is, at most, 2-2 or even 1-1.



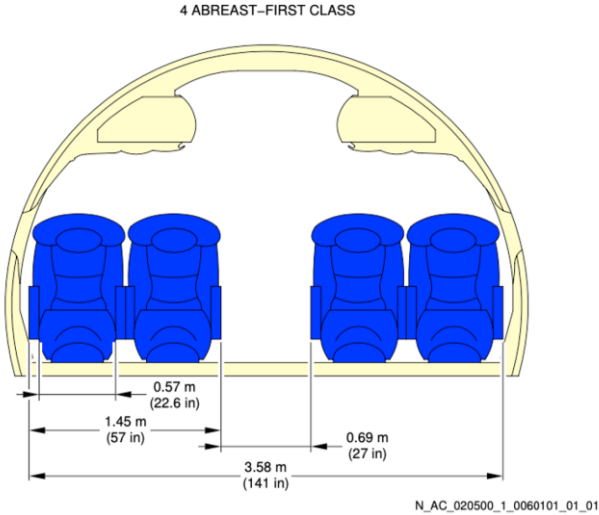
Interior Arrangements - Cross Section  
Economy Class, 6 Abreast - Wider Aisle (Sheet 1 of 2)  
FIGURE-2-5-0-991-005-A01

**Figure 6.12** A321LR cross-section: 6 seat abreast – wider aisle (Airbus 2020)



Interior Arrangements - Cross Section  
Economy Class, 6 Abreast - Wider Seat (Sheet 2 of 2)  
FIGURE-2-5-0-991-005-A01

**Figure 6.13** A321LR cross-section: 6 seat abreast – wider seat (Airbus 2020)



Interior Arrangements - Cross Section  
First-Class

FIGURE-2-5-0-991-006-A01

**Figure 6.14** A321LR cross-section: 4 seats abreast – first-class (Airbus 2020)

## 7 Discussion of the Results

### 7.1 General Considerations and Critic

The real price of the aircraft and engines (Eqn. 2.41) employed in the DOC calculation cannot be ascertained with full assurance unless the exact values are disclosed by the the OEM or the airlines themselves. For this reason, the prices accounted in this theses are based on the average list prices listed by Airbus (2019b), which were then varied in relation to another – i.e., the XLR gets a higher price than the LR, which is more expensive than the neo and the ceo.

The fuel mass ascertained through the iterations in the fuel consumption assessment tool (Scholz 2021b) was not further employed in the DOC assessment. In order to avoid the dependency of the two investigations and also for the sake of simplicity, the fuel mass calculation with the Breguet factor was programmed directly in the own developed DOC tool since all needed values were already present. Nevertheless, an inspection showed that the values with both methods were consistently similar.

All of the aircraft considered offer more than one engine option, which have distinguished take-off thrust and sea-level static thrust. Since these values vary minimally (1-5 kN), it was chosen to employ an average value.

### 7.2 Fuel Consumption

The fuel consumption assessment elucidates the aspect of the operating ranges relative to the design points (B, C, and D) for a given aircraft and assists in the process of discussing the statements made by the OEM and the operators. Through the different visualization, it is possible to indicate which ranges at a given cabin configuration can (still) be operated productively as well as comparing the results to those of other aircraft generations (previous and upcoming). First, these considerations are made disassociated from any sort of cost, ecological, or passenger-related impact.

One starting consideration is the fact that, according to its PRD, the A321neo is capable of an MPL of 25.000 kg, which would translate into a maximum of 257 passengers at 97 kg each, if not for the cabin seating limitations. This means that the design of the A321neo already had considerable reserves, which is somehow unusual, considering the ranges that it usually operates. In other words, this means that the A321neo is generally employed “far” beyond its maximum capabilities if not fully loaded with additional cargo. This consideration solidifies the motivation to extend the range of the aircraft in a variant with additional fuel tanks (ACTs and RCTs) instead of additional cargo.

Regarding the previously mentioned operators of the A321LR (Chapter 6), Figure 7.1 synthesizes the maximum ranges possible at the given cabin configuration without (further) payload reduction. Furthermore, this table displays the corresponding fuel consumption calculated in kg/100km/pax (approximated values). The color-coding indicates whether and to which extent the value is rated as positive or detrimental in relation to the fuel consumption.

**Table 7.1** Overall fuel consumption evaluation regarding the cabin configurations of the A321LR by different airlines

Airline	Cabin Config. (PAX)	Recommended Max. Range (RMR)	Fuel Consumption at RMR (kg/100km/Pax)
Airbus Std.*	202	6800 km	1,57
Air Transat	199	6800 km	1,60
Aer Lingus	184	7400 km	1,76
TAP Air Portugal	171	7450 km	1,83
Air Astana	166	7550 km	1,90
JetBlue	138	7600 km	2,01

First of all, it strikes that in any given case, the previously established M2 (6.500 km) can be operated within a productive and “sensible” fuel consumption per 100 km and pax. Air Transat, the operator with the highest cabin density (199 pax), can operate this range and even surpass it for an extra 300 km without having to block (further) seats. This range is already 13,3% greater than the farthest, by the LR regularly operated route, given in Chapter 2.6 – Lisbon (PT) to Belém (BR) with 6.000 km. By saying this, it is also clearly obvious that the range of the design point B of the LR – 5600km – can also be productively operated, even with maximum seating capacity (240 pax). This is the reason why all ranges are coded with shades of green.

The considered M3, which coincides with the range at MFW of the LR at 7.400 km, is reachable up until a cabin configuration of around 180 pax – in compliance with the structural load limitations. In other words, airlines that employ the LR with a similar cabin configuration (number of pax) to Aer Lingus or lower are also able to operate this range – see Figure 7.1.

Considering that the LR’s cabin can theoretically accommodate 240 pax, it is safe to affirm that most airlines could fly longer missions (than the actual) and still within a productive frame of fuel consumption. In other words, most airlines could either fly further or fit more seats. Furthermore, it strikes that the cabin configuration of JetBlue is very disadvantageous to healthy fuel consumption.

In terms of the fuel consumption per 100 km and passenger, the comparison with other aircraft reveals that the XLR will potentially surpass the LR only after a specific range. Since the aircraft share the same fuselage and engines (i.e., similar efficiency), the advantages of the XLR are only noticeable starting from the point that the LR cannot operate the given mission effectively due to range limitations (not payload). According to the findings in Chapter 3, these ranges are

7600 km, 7200 km, or 6800 km corresponding to low-, standard-, and high-density cabin configuration, respectively. In any mission shorter than these ranges, the LR will generally show lower consumption at a given cabin configuration due to the lower MTOW. Nevertheless, the implementation of ACTs and RCTs has proven itself yet again, as the XLR definitively extends the range without excessively limiting the payload – see Figure 3.1.

The favorable implementation of this technology can be traced back until the Airbus A321neo. Nevertheless, the A321LR will only be more advantageous than the A321neo in given two scenarios:

- in a cabin configuration with more than 170 pax, at a reasonable range – common flight distance, e.g., 2.000 - 4.000 km;
- after a range of around 5.800 km, independent of the cabin configuration. After this range the neo is heavily limited in terms of payload, not even reaching the usual 180 pax for a low-density cabin configuration.

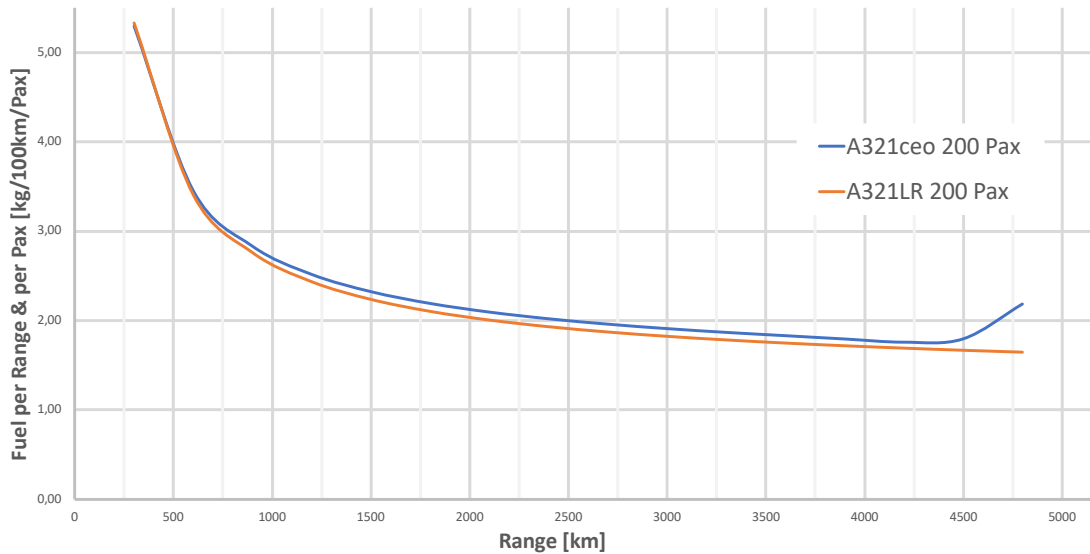
In conclusion, it is only suitable to say that the LR is more fuel-efficient than the neo if the **proper context is given**, i.e., starting from a range of around **5.800 km** or with a **standard to high-density cabin** configuration already at ranges shorter than 5.800 km. Until reaching its range at MPL, the neo should show slightly lower fuel consumption because of the lower MTOW.

As long as the A321 variants are still within their design ranges, the A330-900neo will always show a higher fuel consumption for all ranges and cabin configurations. Only starting from a range of around 8.700 km, the A339 is capable of lower fuel consumption than the XLR – the LR is not operational anymore at this point.

To address the impact of the next generation engines in the A321neo variants (neo, LR, and XLR) relative to the ceo engines, Figure 7.1 was additionally generated. The fuel consumption (kg/100km/pax) is plotted up until 4.800 km since greater ranges are not, in any case, sensible for the ceo, as shown in the chapter before. At 4.400 km, the ceo is still capable of 200 pax, while it is only capable of transporting 158 passengers at 4800 km.

It results that, despite the MTOW difference (the ceo is 8% lighter than the LR) by the fuel consumption outcomes of the two aircraft generations are **very similar**. However, the LR is still more effective than the ceo at any given range. Already starting from 4.400 km, the LR then becomes more fuel-efficient, with the fuel consumption of the ceo rising exponentially together with a heavy payload reduction.





**Figure 7.1** Comparison of the fuel consumption per range and passenger over the flown distance between the A321ceo and the A321LR – 200 pax

It is worth noting that this diagram compares the aircraft and not the engines exclusively. Still, it is safe to affirm that the neo engines, the PW-1100G and the CFM LEAP-1A32, are more efficient than the older generations CFMI CFM-56-5B or IAE V-2533-A5.

With the findings discussed so far, a verdict regarding the affirmations from Airbus (2019) found in the introductory Chapter 1 is now possible.

The affirmations are again the following:

*“... With a range of up to 4,000 NM (7,400 km), the A321LR is the unrivaled long-range route opener, featuring true transatlantic capability and premium wide-body comfort in a single-aisle aircraft cabin.” Airbus (2019)*

and

*“...It [A321LR] delivers 30% fuel savings and [...] compared to previous-generation competitor aircraft.” Airbus (2019)*

The indicated range is also the one found in the LR’s ACAMP (Airbus 2020; see Annex D, Figure D.1), but the fact that the payload at this point is “heavily” limited (i.e., 180 pax à 97 kg) in comparison, to the MPL (max. 240 pax à 97 kg) is left unmentioned. Nevertheless, regarding Table 7.1, this fact is only limiting for two out of the five airlines since they are the only ones that employ more than 180 pax – Air Transat and Aer Lingus. Furthermore, the long-range capabilities of the LR have already been proved so far, and the aircraft is definitively capable of covering transatlantic routes. Regarding the 30% fuel savings towards previous generations, these should also be followed by the range information for more accuracy, since, as shown in Figure 7.1, there is no immediate advantage up until a range of 4.400 km. Despite this,

projections make it possible to affirm that the advantages after this range are very significant (at least 30%), complying with the **scope of the LR**.

The other types of fuel consumption visualization (present in Sections 3.1.2 and 3.1.3) are useful to easily visualize the relationship between the singular MFWs and the ranges of the considered aircraft. Starting from the range at MFW, **both visualizations** show similar behavior for all aircraft until the ferry range.

As a closing note, it is worth highlighting that the results for the specific fuel consumption in kilograms per hundred kilometers and pax are similar to those appointed in the industry and airlines. As an example, Table 7.1 shows the mean specific fuel consumption registered by Lufthansa in the year 2020.

**Table 7.2** Specific fuel consumption and specific CO<sub>2</sub> emissions of the Lufthansa Group (2020) in 2020

- 💧 Values for specific fuel consumption in liters per 100 passenger kilometers (l/100 pkm)
- ☁ Values for specific CO<sub>2</sub> emissions in kilograms per 100 passenger kilometers (kg/100 pkm)

	Total	Long-	Medium-	Short-haul
💧	<b>4.18</b>	3.64	4.12	7.10
☁	<b>10.52</b>	9.15	10.38	17.90

<sup>1</sup> Definitions of traffic areas:

Long-haul more than 3,000 km; Medium-haul 800 to 3,000 km; Short-haul under 800 km.

These values correspond to specific fuel consumptions of 2,86; 3,23; and 5,57 kg/100pax/km, respectively. Despite being average values, i.e., that englobe the whole fleet and missions, they are similar in magnitude and in values to those obtained through the fuel consumption assessment, if an average is built – this reassures the plausibility of the results.

### 7.3 Direct Operating Costs

The DOC assessment represents the financial approach to the operation of the A321LR and was performed extensively in Chapter 4. The most relevant findings were combined in charts, which intend to optimize the interpretation of the results in order to discuss them and draw conclusions. As already mentioned, the use of two different DOC methods makes it possible to

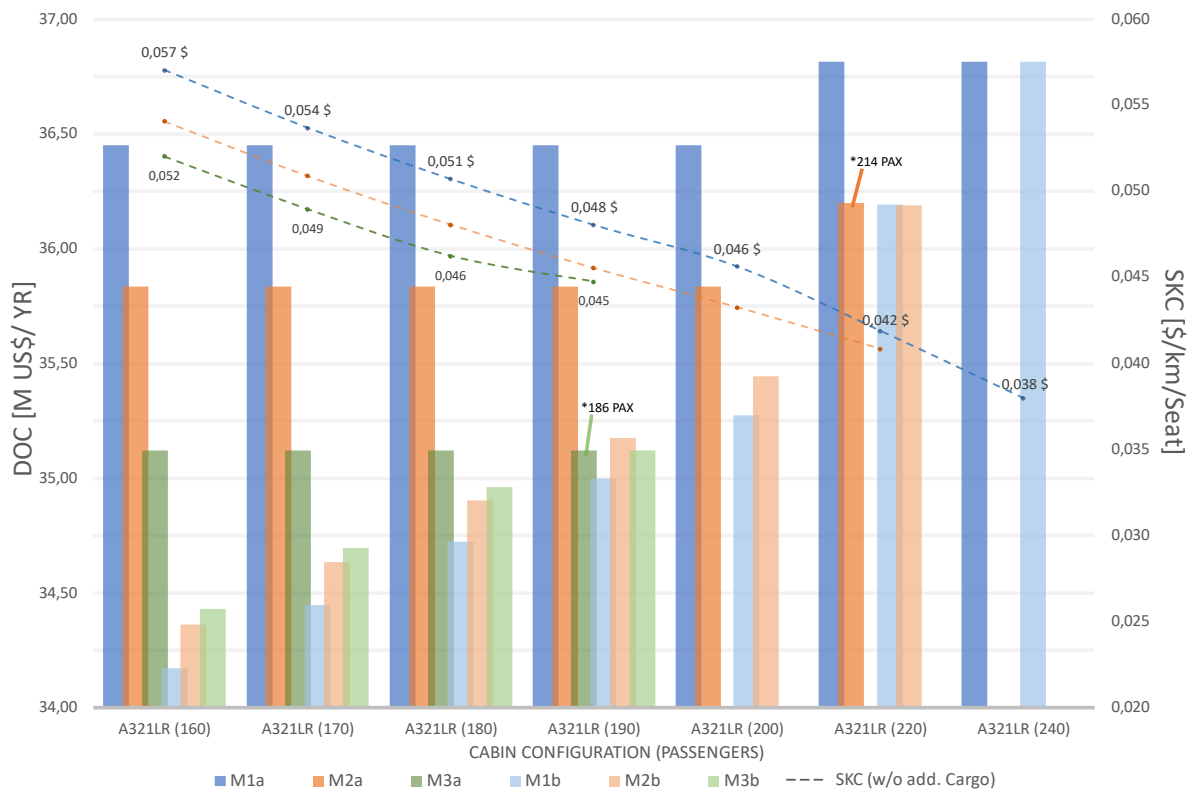
analyze the different distribution of the single cost shares, apart from comparing different aircraft and missions.

For a better follow up, the ranges of the predefined missions are once again listed:

- Mission 1 (M1) coincides with the range at MPL of the LR – 5.600 km
- Mission 2 (M2) is equidistant to the ranges of M1 and M2 – 6.500km
- Mission 3 (M3) coincides with the range at MFW of the LR – 7.400 km

Figure 7.2 shows for all considered missions, with additional cargo (a) until the MPL and without additional cargo (b), the resulting yearly DOCs and Seat-Kilometer Costs (SKC) of the A321LR calculated with the TUB method. For the sake of simplicity, the results with the AEA were omitted. Nevertheless, they can be roughly estimated using a factor of **1,78** (+89%) for the DOCs and **2,52** (+126%) for the SKC.

**Note:** The axis for the DOCs starts at 34,0 M US\$ and the one for the SKCs at 0,020 US\$ (2 cents).



**Figure 7.2** Yearly DOCs and SKCs of the A321LR with the TUB Method: all missions and cabin configurations

First, it strikes that, especially at lower-density cabin configurations, the gap between the DOCs of missions with and without cargo is bigger, and this gap decreases with increasing cabin

density and missions range. As a consequence, airlines should **only fill** the remaining margin until MPL consistently with cargo if the outcome is financially positive, i.e., **if the revenue generated covers the expenses**. If not so, carrying more pax should be more viable instead. For example, in M1a, a total of **8.000 kg** of cargo, i.e., more than **50%** of the  $m_{pax}$ , has to be added in order to reach the MPL! For this reason, the only cost differential between missions with additional cargo remains the number of cabin crews aboard the aircraft, which only depends on the number of passengers.

Furthermore, the SKC will always decrease with an increasing number of passengers and is lower in longer missions, as long as the missions can be productively operated (fuel consumption). Nevertheless, with a cabin configuration of at least 220 pax, SKCs of 0,042 US\$ with M1 are possible with M1, being then lower than the lowest possible with M3 – at 0,045 US\$ and 190 pax. The **lowest seat-kilometer costs** are possible exclusively with **M1** – at 0,038 US\$ and 240 pax – in a combination in which even M2 is not possible anymore.

The highest yearly DOCs, 36,82 M US\$, are incurred for M1a in a 220 pax cabin and also in a 240 pax cabin configuration, independently of carrying additional cargo or not – the MPL is reached. The lowest yearly DOCs, 34,17 M US\$, are registered with M1 in a 160 pax cabin configuration and the exemption of transporting additional cargo.

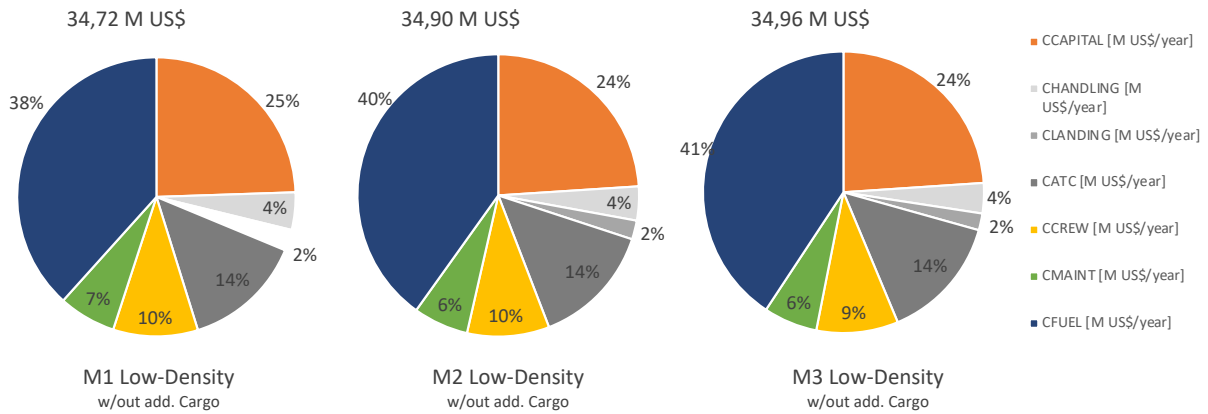
In terms of the ratio DOC/flexibility (without cargo), it seems reasonable to operate the LR with a cabin configuration of around **190 pax** since there is only an **insignificant difference** between the **DOCs** (and SKCs) of the contemplated missions. In other words, airlines would have the **most flexibility** while choosing the routes and with a minimal DOC difference :

- 35,00 M US\$/yr with 713 flight-cycles à 5.600 km
- 35,17 M US\$/yr with 673 flight-cycles à 6.500 km
- 35,12 M US\$/yr with 570 flight-cycles à 7.400 km

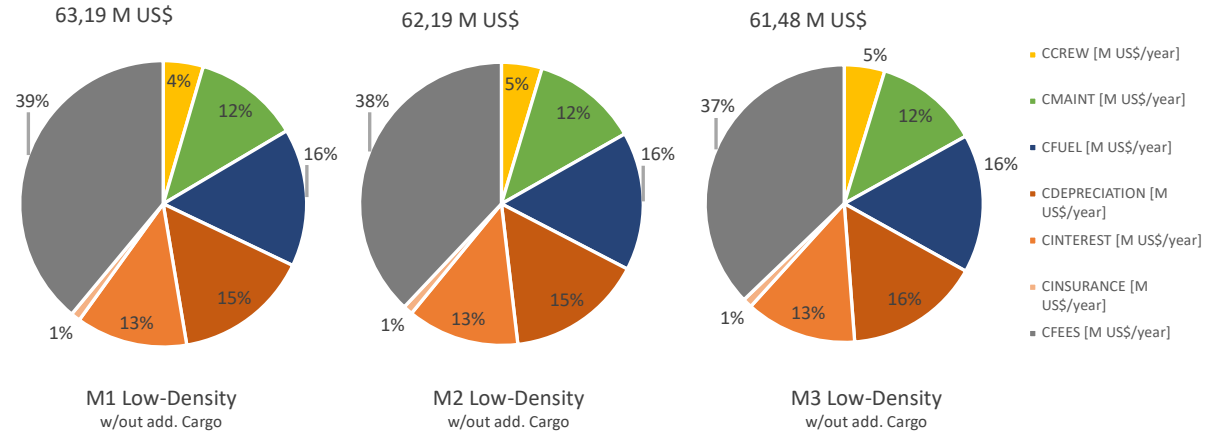
This happens because the effects of flight-cycles and flight distance, which are inversely proportional, **neutralize** each other in this **particular case**. These effects are responsible for the variation of  $C_{FEES}$  and  $C_{FUEL}$ , respectively – see Chapter 4. In order to assess the most profitable option, airlines should consider the difference between ticket prices, i.e., medium-haul versus long-haul, and multiply it by the number of FCs. As an example, should the ticket prices for the flight New York-São Paulo, Brazil (7.400 km) be at least 0,3% higher than in the flight New York-London (5.600 km), the model of M3 will be most profitable – this is mostly the case.

Figures 7.3 and 7.3 intend to address the differences in cost-shares between the two considered DOC methods. In order to be more **realistic**, the cases for **low-density cabin** (180 pax) configurations are presented since the majority of airlines addressed employ a similar

configuration or lower. Furthermore, only missions without additional cargo are accounted for in order to avoid extra expenses and thus allow a direct comparison between the missions themselves. The color coding shall abet the interpretation of corresponding cost shares, e.g., capital costs are in shades of orange and navigation costs in shades of gray.



**Figure 7.3** DOC distribution for the A321LR in M1, M2, and M3: low-density cabin configuration, without additional cargo – TUB Method



**Figure 7.4** DOC distribution for the A321LR in M1, M2, and M3: low-density cabin configuration, without additional cargo – AEA Method

The different methods account for the single cost shares differently. The largest cost share in the TUB method is taken by the fuel costs with a mean of 40% of the total DOCs (13,9 M US\$), whereas the AEA method “only” accounts for 16 % of the total costs incurred for fuel (9,9 M US\$). The largest cost share in the AEA method is taken by the fee costs (ATC, handling, and landing) with around 38% versus 20% of the TUB method. In nominal values, this translates into 23,66 and 6,97 M US\$, respectively. The ratio for the capital costs is similar for both methods. Nevertheless, this represents a nominal difference of 10 M US\$. The only costs which can perhaps be relatable for both methods.

Furthermore, because of the larger fuel accounting, the percentage of the  $C_{FUEL}$  increases with increasing flight range in the TUB method. In the AEA method, this trend is not observed. On the other hand, the AEA method clearly reflects the effect of reducing flight-cycles in the  $C_{FEES}$ .

Figures 7.5 to 7.8 show, for all considered cabin densities, the DOC comparison between the different (applicable) aircraft considered. The first three charts contain the results obtained with the TUB method, and for comparison, Figure 7.8 shows the results for a low-density cabin configuration using the AEA method.

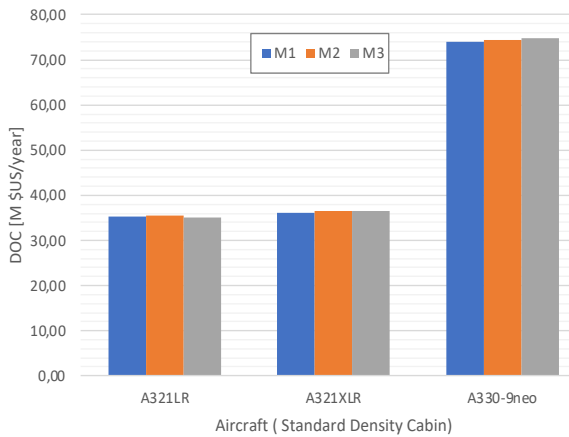


Figure 7.5 DOC comparison: standard density cabin: TUB Method

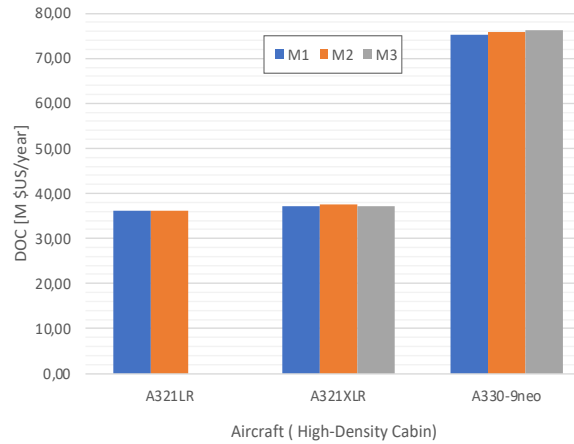


Figure 7.6 DOC comparison: high-density cabin: TUB Method

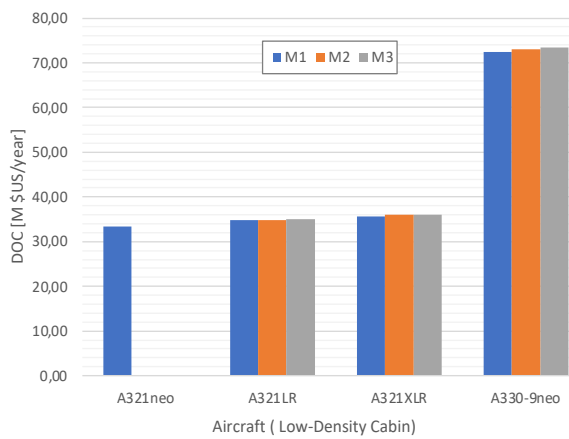


Figure 7.7 DOC comparison: low-density cabin: TUB Method

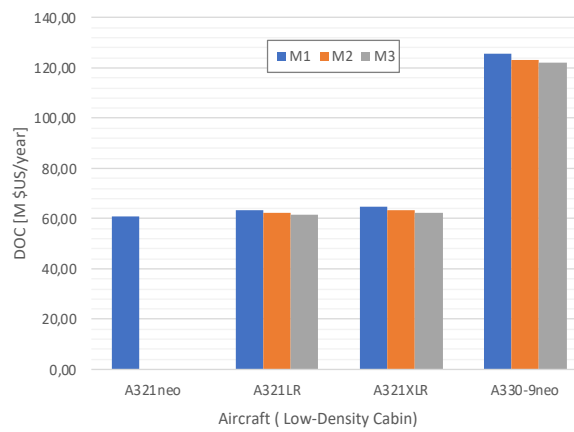


Figure 7.8 DOC comparison: low-density cabin: AEA Method

With this cabin configuration, the DOCs for the XLR are always minimally higher than those of the LR by a mean of +3% or +1 M US\$ per year. This can be justified by the added costs incurred due to the higher MTOW and higher fuel demand, which translate into around 1.400, 1.485, and 1.754 US\$/flight respectively, for M1, M2, and M3 – around 3% percent of the trip

costs. Especially for airlines who haven't yet invested in any of the LR and XLR so far, this may be an interesting finding, which could be taken into account while deciding to acquire one or the other variant.

The yearly DOCs of the A339neo sum up to more than double the mean costs incurred for the LR due to the significantly higher MTOW and fuel demand – at least +35 M US\$. The A321neo can only be employed in M1, being the yearly DOCs around 1,3 or 2,2 M US\$ lower than in the LR, depending on the method.

The yearly DOCs generally increase with increasing cabin density. Furthermore, with the TUB method, the DOCs also increase with increasing flight range, while the opposite happens with the AEA method – as seen before.

Further, the corresponding seat-kilometer costs (SKC) to the previous figures are presented in the same manner in Figures 7.9 to 7.12.

It strikes that, as long as the range is supported with a given cabin configuration (payload-range-diagram), the SKC show falling costs from shortest to largest mission. In other words, the SKCs for M3 are lower than those of M2, which are lower than those in M1. If the given mission and range imply that a payload limitation has to take place, the costs are off course, divided to less pax, e.g., M3 is not possible anymore for the LR using a 200 pax cabin. Instead, only 186 pax are transported.

In this case, even the SKCs for the A339 reach similar or even lower levels to those of the A321 variants due to the longer range and payload capacities. Otherwise, the SKC are generally always higher (1-3 cents), despite accomodating more than double the passengers.

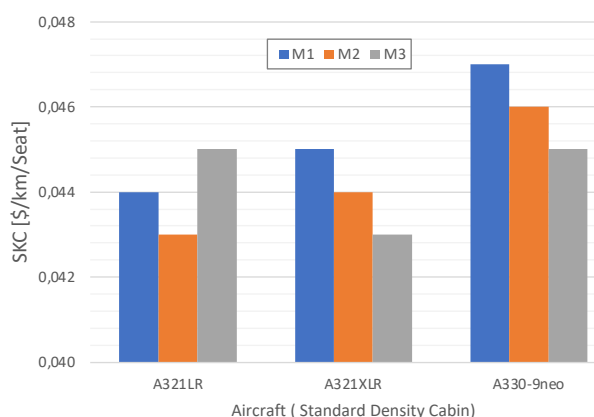


Figure 7.9 SKC comparison: standard density cabin: TUB Method

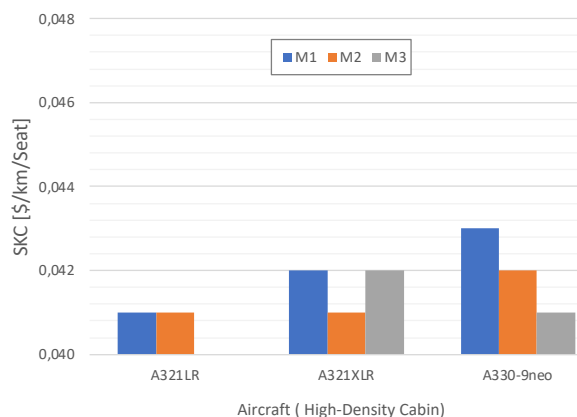


Figure 7.10 SKC comparison: high-density cabin: TUB Method

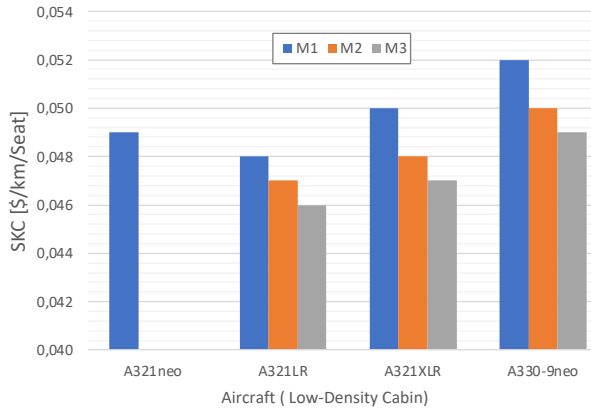


Figure 7.11 SKC comparison: low-density cabin: TUB Method

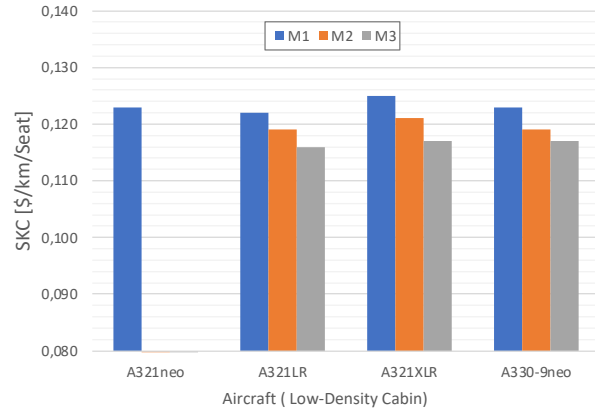


Figure 7.12 SKC comparison: low-density cabin: AEA Method

In the year 2020 the average SKCs appointed by the American low-cost carrier Southwest were around 0,0185 US\$/km per seat (11,48 cents per available seat-mile), whereas the corresponding values for American Airlines were 0,0244 US\$/km per seat in 2018 (Hayes 2021). These values are in all cases lower than those calculated with both methods, which may be justified that the airlines do not include all operating expenses in the SKCs calculation (particular IOCs). However, the TU Berlin appears to be more realistic since the values are closer to those appointed by the airlines.

## 7.4 Ecolabel

One can say that the developed method is capable of reproducing the nuances between different configurations and translating them into logical results in an expected way. Furthermore, the units in which the different categories of the Ecolabel are expressed were chosen very cleverly. For example, by normalizing the fuel consumption and CO<sub>2</sub> emissions (units kg) in kilometers (range) and seats (number of passengers), it is possible to compare aircraft with distinguished ranges and cabin configurations. The units and values can therefore be universally employed between aircraft and are therefore suitable for direct comparisons. The same applies to the local noise level and for the local air pollution (allows to compare engines based on their output thrust).

Before all else, a clear conclusion from the environmental assessment is that the overall rating of the Ecolabel is directly proportional to the total number of seats, i.e., the number of passengers in the aircraft cabin. In other words, this means that the more the passengers transported in a single flight, the better the distribution of the ecological impact. For this matter, this observation gives a leading edge to low-cost carriers in terms of ecological rating since these operators tend to employ very dense cabin configuration in opposition to legacy carriers, who prioritize comfort and thus fewer seats.



Furthermore, it is possible to conclude that the fuel consumption rate – expressed in kilograms of fuel per flown kilometer and per seat – generally worsens with the improvement of the seating class. This happens because the B/C offers fewer seats, more seat pitch, and more seat width than the Y/C. The same applies to the F/C, which performs even worse. Because of this, it can be affirmed that the higher seating classes influence the fuel consumption distribution negatively, and a Y/C seat should be therefore prioritized. This implementation of this measure alone would contribute to a better overall Ecolabel rating for a given airline and aircraft.

The air pollution rating is based on the Emission Index of NO<sub>x</sub> (EI<sub>NO<sub>x</sub></sub>) expressed in grams of NO<sub>x</sub> per kilograms of fuel and corresponding values for each specific aircraft can be retrieved from the official European Environment Agency emission calculator (EEA 2020) – **without distinction of engines types**. The Ecolabel itself, uses another method for this calculation – the Boeing Fuel Flow Method (Hurtecant 2021, pp. 69) – which after a closer look, reveals generally higher values for the NO<sub>x</sub> emissions. This method and its corresponding database have the advantage of possessing a more detailed databank.

Furthermore, despite aircraft mostly having two optional engines, these engines also vary in design so that, in the end, it is not easily ascertainable, which specific variant an airline employs. As expected, the different variants also show nuances in terms of emissions (NO<sub>x</sub>), amongst others. The Ecolabel tries to solve this discrepancy by building an average throughout the engine variants, which has its disadvantages to a certain extent. However, this may be the best solution since, for most cases, it is unlikely to know the exact denomination of the employed engine.

As an example, Table 7.3 shows for the A321ceo, the EI<sub>NO<sub>x</sub></sub> calculated with values from the EEA table at stage length of 1000 NM or 1.850 km and from the Ecolabel. The considered engine type was the **CFM56-5B1/2P**, where a variation of around 20% was found!

**Table 7.3** Comparison of EI<sub>NO<sub>x</sub></sub> between the EEA emission calculator and the Ecolabel

Aircraft	EEA Emission Calculator		Ecolabel		Variation
	Engine	EI_NOx [kg/kg]	Engine	EI_NOx (eng) [kg/kg]	%
A321	Not specified	0,0171	CFM56-5B1/2P	0,0205	+20%

On the other hand, the comparison between different (engine) generations, e.g., neo versus ceo, shows how this reflects in the Ecolabel's overall performance. When compared to the engines of the A321ceo (EIS in 1997), the A321neo's engines (EIS in 2020) are built bigger and are capable of greater thrust. For this matter, these engines consume more fuel than the previous generation, which reflects in the fuel consumption (kg/100km/seat) and in the CO<sub>2</sub> equivalent emissions (kg/km/seat) – see A339 as well. On the other side, by employing more recent and

consequently better technologies the neo engines are more efficient and contribute to lower noise levels (EPNdB/EPNdB) and air pollution (NO<sub>x</sub>/Thrust) in the vicinity of airports.

Furthermore, the comparison between different engines from the “same” generation, e.g., PW-1100G and CFM LEAP-1A32, reveals that the PW-1100G is less air pollutant (in relation to the output thrust) but slightly more noise pollutant in the vicinity of airports. Nevertheless, *if transporting the same number of passengers*, these two engines show the **same values** for the fuel consumption and CO<sub>2</sub> emission – this was not clear at first sight. Overall it is safe to affirm that the Pratt &Whitney engines are overall the better option since the discrepancy in local air pollution is more significant – A-Rating vs. C-Rating of the LEAP 1A32. For the record, the thrust of the two engines is very similar, being 147,28 kN and 143,1 kN for the Pratt &Whitney and for the CFM engines, respectively.

In Annex J, Ecolabels of two other A321LR operators (Air Astana and Aer Lingus) are presented, in which the observations made so far can once again be reassured.

## 7.5 Cabin Layout

It has been made clear that the A321LR offers great cabin flexibility, which opens up plenty of possibilities to its operators. This is only possible because of the engineering technologies implemented, which allow a rapid replacement of seats, even during the turnaround time.

The figures in Chapter 6 showcase obvious differences between a narrower and a larger seat pitch, which can be basically described as a paradigm between *offering more legroom to the passengers or fitting more seat rows in the aircraft cabin*. Each one of the aircraft’s operators hast to face this decision, which lastly depends on their market strategy.

Moreover, demographic implications like the height and overall body measurements of the aimed population also have an influence. Generally speaking, the population of countries like the USA, Germany, or Sweden is generally taller than that of Japan, Vietnam, or Thailand. In other words, a cabin configuration exclusively designed to operate in Vietnam would be expected to feel extremely narrow to an average-sized American tourist or traveler. This constatation sure does not apply to every single citizen from both countries, but for the demographic majority, it should be true. Furthermore, a trend regarding the two different genders (male and female) is showcased and should apply independently of the demography – men are generally taller than women.

The background of the considerations made above are ergonomic implications, which were addressed in Table 6.1 – the buttock-knee-length (BKL) is the main measurement to take into account while assessing the seat pitch. This dimension directly influences the clearance (space)

at knee height towards the next seat. If too narrow, passengers will for sure experience discomfort, especially on long flights. For this matter, it was ascertained that the male percentile should be the one considered for the definition of the seat pitch since female passengers will, in most cases, always have more legroom available.

Considering the most common seat pitches in the economy class appointed by SeatMaestro (2021a), 29” has proven to be insufficient (no clearance for the 95% American male) and 34” to be perhaps somehow excessive, at least in the eyes of low-cost airlines. A seat pitch between 31” and 33” in economy class for the American population should be more reasonable, depending on the airline market strategy – low-cost or a legacy carrier. In any case, the conglomeration of all the factors discussed so far leads to the conclusion that some **compromises** have to be made when choosing the best seat pitch since **there is not a perfect configuration** applicable to every single market, mission, and demography.

On the other hand, it is a fact that airlines normally “grant” more space (seat pitch) to passengers in the B/C and F/C while simultaneously equipping those seats with better, dedicated, in-flight entertainment (IFE). Overall, these sorts of seats portray a certain aspect of luxury and represent an upgrade to the passenger in terms of comfort, servicing, as well as for psychological satisfaction. Furthermore, another characteristic of the differentiation between seating classes is the difference in seat widths. It was shown that B/C and F/C seats are also generally wider than those of the Y/C (Figures 6.12 to 6.14), aside from benefiting from dedicated galleys and toilets (Figures 6.9 to 6.11).

The symbiosis of these two aspects, seat pitch and seat width, can be observed in the case of JetBlue (American airline). This airline shows for all seating classes larger seat pitch and seat width than all the European and Asian airlines taken into account, culminating in a **significantly reduced total number of seats** in the LR’s cabin – less 30% than the airline with the most seats and less 17% than the airline with the second least seats.

The following **closing considerations** could be extracted from the cabin layout assessment:

- the longer the flight, the more important the seat pitch gets;
- the seat pitch and seat pitch (should) take ergonomic aspects into account;
- low-cost carriers prioritize more seating rows – more seats, at a lower price;
- legacy carriers prioritize offering more comfort and better in-flight service at a corresponding (higher) price – fewer seats, at a higher price;
- the total number of seats has a major influence on the DOC, fuel consumption, and Ecolabel of the mission.

## 8 Summary and Conclusions

This thesis offers a deeper insight into the Airbus A321LR. It was possible to have a better understanding of the operational aspects surrounding this aircraft, which could be of great interest to the airlines that operate or intend to operate this aircraft, as well as to the verification of the engineering implementation.

For most cases, theoretical DOC methods will deliver different costs than those published by airlines. Nevertheless, the assessment performed in Chapter 4 and summarized in Chapter 7.3 made it possible to rank the considered aircraft in terms of operating cost for the particular missions and clarify the relationship between flight cycles, flight time, and total costs.

Furthermore, a crucial objective of this thesis was to understand the implementation of the ACTs (to the A321neo) in order to fly larger ranges. It was postulated whether the accommodation of additional tanks and consecutively fuel would significantly impact the maximum possible payload in the LR, resulting in major limitations in the total number of passengers to be carried – **this is not the case**. For relatively shorter ranges, the A321neo can for sure exhaust its MPL of 25.500 kg (against 23.580 kg for the LR), but this does not translate in more seating passengers due to the geometrical limitations of the cabin (maximum of 244 passengers). With unlimited cabin dimensions, the neo would carry a maximum of 262 pax à 97 kg against the already theoretically possible 243 pax of the LR. This means that the remaining payload in the A321neo has to be necessarily filled with cargo or, in other words, that this aircraft could perhaps have been designed at a lower MTOW.

This analysis extended to the A321ceo shows that the main advantage of the neo family lies in the improved NEO engines (LEAP-1A and PW-1100G), which surpass the previous generations in terms of fuel consumption and technology and is clearly shown in Chapters 3 and 7.2 – there is a 20 years gap between the EIS dates.

Furthermore, as of today, there are plenty of A321LR already in operation and several pending orders. Especially with the incoming XLR, it is sensible to address the most logical and profitable employment of the LR. The answer to this reasonable question appears as a symbiosis of Chapters 3 and 4, which assess the fuel consumption and the DOC of the Airbus A321LR in comparison to other aircraft, respectively. By raising the MTOW by 4,1%, the XLR can accommodate around 20,3% more fuel while lowering the MPL by 5,2% (reflected in the MZFW). Nevertheless, the payload-range advantages become firstly evident only after a flight range of 7.400 km, in comparison to the LR.

For airlines that have been only operating A321neos so far, the only cases in which an **upgrade** to the **LR** is not justifiable is if they only employ very-low-density cabin configurations, e.g.,

less than 170 seats. For all other cases, the LR is clearly the **best choice**, independent of the flight range.

Towards the larger A330-900neo, the decisive aspects are the MTOW, MFW, and the MPL, which lastly reflect in the maximum flyable ranges. It can be stated that the A320 family and the A339 serve different purposes. The latest shall be employed in medium- to long-haul segments with high passenger volume and in which a reasonable load factor is guaranteed. By doing so, the higher fuel consumption, operating costs, as well as environmental pollution incurred can be justified. It is again worth highlighting that the A339 will only reach lower SKCs than the A320 family, in case the mission range clearly exceeds the range capacities of these aircraft. For all other reasonable cases, the SKCs of the A339 are not by any means lower, despite accommodating significantly more passengers in a similar cabin configuration. This again reinstates the idea of market-based decisions taken by the airlines.

The Ecolabel investigation aggregates an environmental assessment perspective to this research. By the time of the delivery of the thesis, the COP26 was being parallelly held, in which agreements regarding the world climate are being discussed by the 197 united nations (UN). For this reason, it becomes an increasing priority to assess the ecological impact of aviation in general by developing and employing tools that provide a reliable classification of the activities inherent to the aircraft's operation. As mentioned in Chapter 5, there is, as of today, no unified tool for this assessment, and therefore, the method introduced by Scholz (2020) and explained in the master thesis of Hurtecaant (2021) was employed. It was possible to compare not only the different aircraft generations, in which the influence of the engines are evident, but also the different cabin configurations, highlighting the advantage of flying with a higher density cabin.

With higher cabin density configurations, the A321LR achieved high A-Ratings, which decreased to low B-Ratings with low-density cabin configurations – e.g., JetBlue with around 56% of the maximum seat-passengers. These constations point to a generally “better” Ecolabels per flight for low-cost airlines like RyanAir, EasyJet, and WizzAir in comparison to legacy carriers like Lufthansa, United Airlines, and British Airways. Low-cost airlines tend to showcase high-density cabin configurations in order to carry the most passengers possible at the cost of comfort and thus making it possible to offer lower prices. On the other hand, legacy carriers rely on offering comfortable flights and upgraded in-flight services for selected routes, and thus higher costs.

Overall, the Ecolabel assessment allowed a better perception of the implications of airlines' and passengers' choices while flying aircraft, as they condition our ecosystem. Furthermore, it stimulates more awareness towards this very important thematic in general

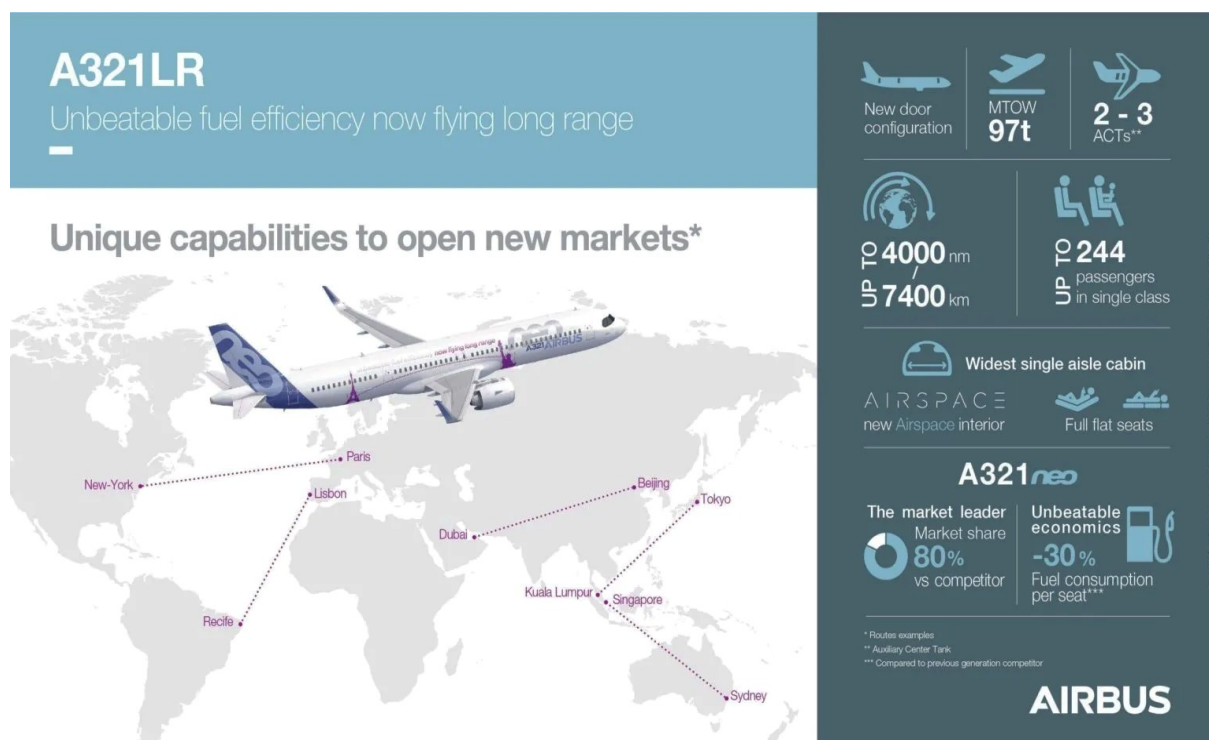
This last aspect – the cabin configuration – is addressed in Chapter 6, disassociated from monetary and environmental impacts focusing instead solely on the ergonomic aspects incurred

and the geometrical cabin limitations of the A321LR. It became evident that a very narrow seat pitch causes discomfort to very tall passengers, especially in long flights. A sensible seat pitch of at least 31" was ascertained based on the average American population in order to cover all the relevant percentiles' body measurements (both genders) comfortably.

Airlines have to choose between offering more legroom to the passengers (legacy carriers) and fitting more seating rows across the aircraft cabin (low-cost carriers). Furthermore, business class and first-class seats offer more seat pitch, seat width, and in-flight services than economy seats. However, this is only possible due to the high flexibility of the LR's cabin, allowing operators to configure the layout according to their needs – e.g., by varying the number and placement of galleys and toilets, aside from the sort and number seat rails.

Overall, it was possible to establish a foundation in which the affirmations stated by Airbus and the airlines could be critically analyzed. The investigations have shown that the LR is an aircraft, which offers great advantages in terms of range, cabin flexibility, fuel consumption, and emissions. For this reason, the LR would represent a valuable addition to every airline's fleet and is hereby recommended.

Fly Safe.



**Figure 8.1** Infographic and possible routes for the Airbus A321LR (Meilen Optimieren 2021)

## List of References

AEROFLOT, 2018. *Glossary*. Accessed December 2, 2021.

Available from: <https://bit.ly/3dfWbCZ>

Archived at: <https://perma.cc/ZE5P-W3YJ>

AIR ASTANA, 2021. *Fleet and seat maps*. Air Astana. Accessed December 3, 2021

Available from: <https://bit.ly/3C9Wee9>

Archived at: <https://perma.cc/EKY4-47M6>

AIRBUS, 2018a. *Arkia israeli airlines takes delivery of world's first A321LR*. Airbus. Accessed December 3, 2021

Available from: <https://bit.ly/3n82DQK>

Archived at: <https://perma.cc/27AZ-TNMB>

AIRBUS, 2018b. *Airbus delivers first A330-900 to launch operator TAP air portugal*. Airbus. Accessed December 4, 2021.

Available from: <https://bit.ly/3rErrDZ>

Archived at: <https://perma.cc/629R-BHDA>

AIRBUS, 2019a. *TAP air portugal takes delivery of its first A321LR*. Airbus. Accessed December 3, 2021

Available from: <https://bit.ly/3p51Lxv>

Archived at: <https://perma.cc/ZBH9-9CB5>

AIRBUS, 2019b. *Airbus aircraft 2018 average list prices*. Airbus. Accessed November 28, 2021.

Available from: <https://bit.ly/3xto3Nf>

Archived at: <https://perma.cc/5ZKT-XNQA>

AIRBUS, 2019c. *Airbus launches longest range single-aisle airliner: the A321XLR*. Airbus. Accessed October 18, 2021.

Available from: <https://bit.ly/3BXZLwc>

Archived at: <https://perma.cc/7E26-UHKS>

AIRBUS, 2020. A321. *Aircraft characteristics. Airport and maintenance planning*. Airbus. Accessed October 18, 2021.

Available from: <https://bit.ly/3Gd4HPy>

Archived at: <https://perma.cc/3HL8-86BT>

AIRBUS, 2021d. *A321neo. The most successful commercial aircraft family ever.* Airbus. Accessed December 4, 2021.

Available from: <https://bit.ly/3DkhQV3>

Archived at: <https://perma.cc/CGA7-H57U>

AIRBUS, 2021a. *JetBlue takes delivery of A321LR with the first airspace interior.* Airbus. Accessed November 28, 2021.

Available from: <https://bit.ly/3I2rFL2>

Archived at: <https://perma.cc/57WA-7TRG>

AIRBUS, 2021b. *Orders and deliveries. Commercial aircraft.* Airbus. Accessed November 28, 2021.

Available from: <https://bit.ly/3I11hRt>

Archived at: <https://perma.cc/L6JA-9QHJ>

AIRBUS, 2021c. *A330. Aircraft characteristics. Airport and maintenance planning.* Airbus. Accessed October 18, 2021.

Available from: <https://bit.ly/3Gd4HPy>

Archived at: <https://perma.cc/X9QJ-HGH5>

ANDREW, 2020. *Scoot removes A320 seats to meet cargo demand.* Mainly Miles. Accessed October 18, 2021.

Available from: <https://bit.ly/2XpUZso>

Archived at: <https://perma.cc/U9AS-KVWU>

BODELL, Luke, 2020. *28 years ago the airbus A330 flew for the first time.* Simple Flying. Accessed December 2, 2021.

Available from: <https://bit.ly/31IloIg>

Archived at: <https://perma.cc/3EHP-M74N>

BURZLAFF, Marcus, 2017. *Aircraft fuel consumption – Estimation and visualization.* Project. Hamburg, Germany: Hochschule für Angewandte Wissenschaften Hamburg.

Available from: <http://nbn-resolving.org/urn:nbn:de:gbv:18302-aero2017-12-13.019>

Available from: <https://doi.org/10.7910/DVN/2HMEHB> (Excel file)

BUSINESS WIRE, 2021. *Jetblue takes delivery of first airbus A321LR aircraft enabling airline to launch first-ever transatlantic service.* Business Wire. Accessed December 4, 2021.

Available from: <https://bwnews.pr/3AMcJMc>

Archived at: <https://perma.cc/3B4L-GN3T>



- COLLINS DICTIONARY, 2021. *Fuel consumption*. Collins Dictionary. Accessed December 2, 2021.  
 Available from: <https://bit.ly/3xLaoB8>  
 Archived at: <https://perma.cc/54EU-LXFM>
- DEPITRE, Alain, 2006. *Noise certification workshop*. Bangkok, Noisedb. Accessed July 1, 2021.  
 Available from: <https://bit.ly/3G7D6QG>  
 Archived at: <https://perma.cc/Z484-EW59>
- EASA, 2009. *Survey on standard weights of passengers and baggage. Final Report*. Accessed December 2, 2021.  
 Available from: <https://bit.ly/3Dgx3qm>  
 Archived at: <https://perma.cc/A8C3-TERE>
- EASA, 2019. *European Aviation Environmental Report 2019*. Accessed November 20, 2021  
 Available from: <https://doi.org/10.2822/309946>
- EEA, EMEP, 2020. *1.A.3.a Aviation 1 Master emissions calculator 2019*. European Environment Agency. EEA Europe. Accessed December 3, 2021  
 Available from: <https://bit.ly/3DCB6xr>  
 Archived at: <https://bit.ly/3ooQJ75> (Permalink)
- EIA, 2021. *U.S. gulf coast kerosene-type jet fuel spot price FOB*. Accessed October 19, 2021.  
 Available from: <https://bit.ly/3BWUBAE>  
 Archived at: <https://perma.cc/VVC2-45FM>
- EISELIN, Stefan, 2021. *Air transat hat lust auf mehr airbus A321LR*. Aero Telegraph. Accessed October 18, 2021.  
 Available from: <https://bit.ly/3IPAVZK>  
 Archived at: <https://perma.cc/2GU2-P4ML>
- ENVIRONMENTAL CHOICE NEW ZEALAND, 2021. *Ecolabelling*. Accessed December 2, 2021.  
 Available from: <https://bit.ly/3xUVoAY>  
 Archived at: <https://perma.cc/M4UA-PB5B>
- ERGOCENTER NCSU, 2006. *Antropometric data*. Accessed October 18, 2021.  
 Available from: <https://bit.ly/3n3b1kP>  
 Archived at: <https://perma.cc/3QXN-GDBD>

EUROCONTROL, 2005. *Glossary for flight statistics & forecasts*. Accessed December 2, 2021.

Available from: <https://bit.ly/3prYCrU>

Archived at: <https://perma.cc/3UM7-P3ZL>

DRURY, Colin, 2010. Work design. in FAA, 2010. *Operator's manual: human factors in aviation maintenance*. Chapter 6. [s.l], [s.n]. Accessed October 18, 2021.

Available from: <https://bit.ly/3DXdMel>

Archived at: <https://perma.cc/M6S3-G35S>

FAA, 2015. *Aviation emissions, impacts & mitigation: a primer*. Accessed May 28, 2021.

Available from: <https://bit.ly/3AYitCM>

Archived at: <https://perma.cc/4D6Z-NTFF>

FARMBROUGH, Heather, 2019. *Flight shame: BBC interview with greta thunberg raises a modern dilemma*. Forbes. Accessed October 18, 2021.

Available from: <https://bit.ly/2Xqvh76>

Archived at: <https://perma.cc/6CGY-LPRW>

GOOGLE EARTH PRO, 7.3.4.8248 (64-bit), OpenGL. Mac OS X (10.16.0). Earth, globe. [Online] Digital Globe 2021. Accessed October 15, 2021.

Available from : <http://www.google.com/earth/index.html>

GOSENDE, Pablo, 2017. *Anthropometry-based approach for side-mounted desktop chairs design evaluation for university students in ecuador*. Guayaquil, Engineering Faculty, Salesian Polytechnic University. ResearchGate. Accessed October 18, 2021.

Available from: <https://bit.ly/3IQBxyp>

Archived at: <https://doi.org/10.1109/ETCM.2017.8247516>

HARDIMAN, Jake, 2020. *The airbus A321XLR – A plane that will change the world*. Simple Flying. Accessed December 3, 2021.

Available from: <https://bit.ly/3G8PdMh>

Archived at: <https://perma.cc/WPV4-GFEK>

HARDIMAN, Jake, 2021. *What are the differences between an A321ceo and A321neo?*. Simple Flying. Accessed December 2, 2021.

Available from: <https://bit.ly/3dftLZU>

Archived at: <https://perma.cc/FEP5-S4H2>

HAYES, Adam, 2021. *Cost Per Available Seat Mile (CASM)*. Invesopedia. Accessed December 3, 2021

Available from: <https://bit.ly/3lC5y4q>

Archived at: <https://perma.cc/F86K-LK66>

HERVEY-BATHURST, Isabella, 2019. “*Flygskam*” – *the very real impact of climate change on swedish airlines*. Schroders. Accessed October 18, 2021.

Available from: <https://bit.ly/3lNy8Am>

Archived at: <https://perma.cc/F24G-F89X>

HONIG, Zack, 2018. *Comparing economy seat pitch on the new airbus A220-300*. The Points Guy. Accessed October 18, 2021.

Available from: <https://bit.ly/3n83a5z>

Archived at: <https://perma.cc/55ST-WLMK>

HURTECANT, Daan, 2021. *Launch of an ecolabel for passenger aircraft*. Master Thesis. Hamburg: Hochschule für Angewandte Wissenschaften Hamburg.

Available from: <https://bit.ly/3jcOhxy>

Archived at: <https://doi.org/10.7910/DVN/LU5VAZ>

IATA, 2021. *Jet fuel price monitor*. Accessed December 2, 2021.

Available from: <https://bit.ly/3oiVBdK>

Archived at: <https://perma.cc/8C5K-VP3E>

IATA, 2018. *IATA passenger glossary of terms*. Accessed December 2, 2021.

Available from: <https://bit.ly/3EhPX13>

Archived at: <https://perma.cc/3R5B-3JC9>

ICAO, 2020. *ICAO glossary*. Accessed December 2, 2021.

Available from: <https://bit.ly/3G7IouG>

Archived at: <https://perma.cc/2YG7-TPME>

JETBLUE, 2021a. *Jetblue set to bring transatlantic travelers low fares, new choices and incredible service as it lands at both london heathrow and london gatwick*. Accessed October 18, 2021.

Available from: <https://bit.ly/3AQgbp1>

Archived at: <https://perma.cc/DYA6-YBAA>

JETBLUE, 2021b. *Meet the A321 long range*. Accessed October 18, 2021.

Available from: <https://bit.ly/3BNkkeJ>

Archived at: <https://perma.cc/LM6P-JSAQ>

- KREMSER, Florian; GUENZKOFER, Fabian; SEDLMEIER, Claudia; SABBAH, Olaf; BENGLER, Klaus, 2012. *Aircraft seating comfort: the influence of seat pitch on passengers' well-being*. Work. 2012;41. [s.l], IOS Press. Accessed October 18, 2021.  
Available from: <https://doi.org/10.3233/WOR-2012-0789-4936>  
Archived at: <https://perma.cc/WFM2-TCDD>
- LUFTHANSA GROUP, 2020. *FUEL CONSUMPTION AND EMISSIONS, Specific fuel consumption 2020*. Lufthansa Group. Accessed December 3, 201  
Available from: <https://bit.ly/3Imle5r>  
Archived at: <https://perma.cc/E3CA-4LEL>
- MACDONALD, Allan, 2012. *A general view on fuel efficiency in commercial aviation*. Master Thesis. Hamburg: Hochschule für Angewandte Wissenschaften Hamburg. Accessed October 19, 2021.  
Available from: <https://bit.ly/3aOljj5>  
Archived at: <https://perma.cc/4AYW-YNZY>
- MASSY-BERESFORD, Helen, 2007. *Flybe promotes green issues with its 'ecolabel.'* FlightGlobal. Accessed June 1, 2021.  
Available from: <https://bit.ly/3vlfIQ9>  
Archived at: <https://perma.cc/SQ89-MMCC>
- LOTHAR, 2021. *Zweistrahler im portrait: der airbus A321*. Meilen Optimieren. Accessed December 1, 2021.  
Available from: <https://bit.ly/31i0Bqv>  
Archived at: <https://perma.cc/E6ST-96F9>
- MOTTFITT, Matt, 2020. *What is considered a short-haul, medium-haul and long-haul flight?* Point Hacks. Accessed December 2, 2021.  
Available from: <https://bit.ly/3De8v0Z>  
Archived at: <https://perma.cc/JTZ6-CVT5>
- MURPHY, Enda; KING, Eoin, 2014. Environmental noise pollution. in MURPHY, Enda. *Environmental noise pollution noise mapping, public health, and policy*. pp.1-7. [s.l], Elsevier. Accessed May 28, 2021.  
Available from: <https://doi.org/10.1016/B978-0-12-411595-8.00001-X>  
Archived at: <https://perma.cc/55UK-RDWF>
- OPEN ERGONOMICS, 2021. *Introduction to anthropometry*. Accessed October 18, 2021.  
Available from: <https://bit.ly/3lRnloF>  
Archived at: <https://perma.cc/RF9G-4JBF>

- PEARSON, James, 2021a. *Revealed: the longest airbus A321neo routes this winter*. Simple Flying. Accessed October 18, 2021.  
 Available from: <https://bit.ly/30EeKOb>  
 Archived at: <https://perma.cc/MBZ4-TXR9>
- PEARSON, James, 2021b. *The incredible rise of transatlantic A321LR narrowbody flights*. Simple Flying. Accessed December 4, 2021.  
 Available from: <https://bit.ly/3ARGY10>  
 Archived at: <https://perma.cc/2KAP-GKBA>
- ROSKAM, Jan, 1989. *Airplane Design. Vol. 1 : Preliminary Sizing of Airplanes*, Ottawa, Kansas, 1989. - Sale: Analysis and Research Corporation, 120 East Ninth Street, Suite 2, Lawrence, Kansas, 66044, USA  
 Available from: <https://amzn.to/3lxqucM>
- SAMPSON, Ben, 2019. *Airbus launches even longer range A321*. Aerospace Testing International. Accessed December 2, 2021.  
 Available from: <https://bit.ly/3cUUVFh>  
 Archived at: <https://perma.cc/C9WY-R9JC>
- RILEY, Charles, MULLEN, Jethro, 2019. *End of the superjumbo: airbus is giving up on the A380*. CNN Business. Accessed November 28, 2021.  
 Available from: <https://cnn.it/3FRA95K>  
 Archived at: <https://perma.cc/WGM4-SNDM>
- SATAIR, 2020. *Components and line replaceable units*. Accessed October 18, 2021.  
 Available from: <https://bit.ly/3BX6dna>  
 Archived at: <https://perma.cc/Z3VY-GZBZ>
- SCHOLZ, Dieter, 2011. *Material zur vorlesung Flugmechanik mit Labor*. Lecture Series. Hamburg, Germany: Hochschule für Angewandte Wissenschaften Hamburg.  
 Available from: <https://bit.ly/3DTt2IX>  
 Archived at: <https://bit.ly/2ZRDbYg> (Web Archive)
- SCHOLZ, Dieter, 2013. *DOC-Assessment method: TU berlin - DOC method*. Presentation. At 3rd Symposium on Collaboration in Aircraft Design, 19.09.2021. Linköping, Sweden. Accessed December 4, 2021.  
 Available from: <https://bit.ly/3na0ILA>  
 Archived at: <https://perma.cc/4E2U-U7JZ>

SCHOLZ, Dieter, 2015. *Aircraft design*. Lecture Series. Hamburg, Germany: Hamburg Open Online University (HOOU).

Available from: <https://bit.ly/3dizHBk>

SCHOLZ, Dieter, 2021a. *Aircraft Fuel Consumption – Estimation and Visualization. FuelCalculation\_SLZ* (Excel File). Hamburg, Germany: Hochschule für Angewandte Wissenschaften Hamburg.

Available from: <https://doi.org/10.7910/DVN/2HMEHB> (Excel file)

SCHOLZ, Dieter, 2021b. *PreSTo – Aircraft Preliminary Sizing Tool: PreSTo-DOC. PreSTo-DOC\_1.0* (Excel File). Hamburg, Germany: Hochschule für Angewandte Wissenschaften Hamburg.

Available from: <https://bit.ly/3Gazn3Q> (Excel file)

SCHOLZ, Dieter, 2020. *Ecolabel for aircraft – definition and application*. Hamburg Aerospace Lecture Series (DGLR, RAeS, VDI, ZAL, HAW Hamburg), Hamburg, Germany.

Available from: <https://doi.org/10.5281/zenodo.4462458>

SEATGURU, 2021a. *Air transat seat maps*. Accessed October 18, 2021.

Available from: <https://bit.ly/3jfEVkz>

Archived at: <https://perma.cc/Z4NG-UD6A>

SEATGURU, 2021b. *TAP portugal seat maps - Airbus A321LR*. Accessed October 18, 2021.

Available from: <https://bit.ly/30sFUaw>

Archived at: <https://perma.cc/5EUS-LF95>

SEATGURU, 2021c. *Frequently asked questions. What is Seat Pitch*. Accessed October 18, 2021.

Available from: <https://bit.ly/2XluvrS>

Archived at: <https://perma.cc/QLF3-ZJJP>

SEATGURU, 2021d. *Aer lingus seat maps - Airbus A321LR*. Accessed October 24, 2021.

Available from: <https://bit.ly/3BbZWme>

Archived at: <https://perma.cc/6MXF-EJ52>

SEATGURU, 2021e. *Aer Lingus seat maps - Airbus A321LR*. Accessed October 24, 2021.

Available from: <https://bit.ly/3BbZWme>

Archived at: <https://perma.cc/6MXF-EJ52>

- SEATMAESTRO, 2021a. *On legroom and airplane seat pitch*. Accessed October 18, 2021.  
Available from: <https://bit.ly/3BW0xKi>  
Archived at: <https://perma.cc/E4UX-LVM4>
- SEATMAESTRO, 2021b. *Seat map jetblue airways - airbus A321 config 2*. Accessed October 18, 2021.  
Available from: <https://bit.ly/3pbA1ZA>  
Archived at: <https://perma.cc/8NPM-CZ9J>
- WALTON, John, 2016. *Half-inch seat fitting promises seat pitch flexibility; what of #PaxEx?*. Runway Girl Network. Accessed October 18, 2021.  
Available from: <https://bit.ly/2Z1Jbg8>  
Archived at: <https://perma.cc/7HG6-ACNK>
- WATOG, 1992. *Airline industry standard world airlines technical operations glossary: WATOG*. 14<sup>th</sup> ed. Washington DC, Air Transport Association of America.  
Available from: <https://bit.ly/3rDIS90>
- WELTREISENDER, 2021. *TAP air portugal nimmt ersten airbus A321LR in betrieB*. Accessed October 18, 2021.  
Available from: <https://bit.ly/3jcVrC0>  
Archived at: <https://perma.cc/ZSN9-Z5EM>
- WOLFSTELLER, Pilar, 2021. *JetBlue takes delivery of its first A321LR*. FlightGlobal. Accessed November 28, 2021.  
Available from: <https://bit.ly/3xyMetO>  
Archived at: <https://perma.cc/HBV7-CDZN>
- WHO, 2021. *Noise*. World Health Organization Regional Office for Europe. Accessed June 6, 2021.  
Available from: <https://bit.ly/3vVXqPi>  
Archived at: <https://perma.cc/ES28-H2AV>
- WULLBRAND, Finn, 2016. *Auswirkungen einer stützstrebe auf die flügelmasse und die flugleistungen am beispiel der ATR 72-600*. Bachelor Thesis. Hamburg, Germany: Hochschule für Angewandte Wissenschaften Hamburg. Accessed November 22, 2021.  
Available from: <https://bit.ly/3jiyU6H>  
Archived at: <https://perma.cc/CZ9L-MESA>
- YOUNG, Trevor M., 2017. *Performance of the jet transport airplane: analysis methods, flight operations, and regulations*. New Jersey, John Wiley & Sons.  
Available from: <https://doi.org/10.1002/9781118534786>

## Appendix A – User Interface of the Excel Tool Used for Fuel Calculation

Maximum Take-off Mass	<input type="text" value="97000"/> kg	Cabin Seats	<input type="text" value="160"/>	Payload Reduction Method <input checked="" type="radio"/> Cargo first (default) <input type="radio"/> Cargo and pax in parallel
Maximum Zero Fuel Mass	<input type="text" value="75600"/> kg	Passenger Mass	<input type="text" value="97"/> kg	
25790 26890 Maximum Fuel Mass	<input type="text" value="25790"/> kg	Range (for single calculation)	<input type="text" value="9.000"/> km	Rules for Reserves <input checked="" type="radio"/> International (default) <input type="radio"/> Domestic
Operation Empty Mass	<input type="text" value="52060"/> kg	Distance to alternate	<input type="text" value="370.4"/> km	
Mach number in cruise	<input type="text" value="0.82"/>	Reserves on distance	<input type="text" value="5%"/>	
<b>3. Calculation of Graphs</b>				
Plot from Range	<input type="text" value="300"/> km	<input type="button" value="Calculate Graphs"/>		
Plot to Range	<input type="text" value="9200"/> km			
Plotting Interval	<input type="text" value="300"/> km			
<b>4. Results: Fuel consumption on 9000 km range</b>				
Reserve distance	<input type="text" value="820"/> km	Fuel per Range & Pax	<input type="text" value="6.89"/> kg/100km per pax	
Reserve time	<input type="text" value="30"/> minutes	Fuel per Range	<input type="text" value="2.57"/> kg/km	23093,95184
Reserves fuel (from dist. & time)	<input type="text" value="2916"/> kg	Fuel per Payload	<input type="text" value="6.397"/> kg/kg	9000
Used fuel for this trip	<input type="text" value="23094"/> kg			37,21649485

**Figure A.1** Input, calculation and output of the fuel calculation tool: MTOW, MZFW, MPL, MFW, OEM, Seat-Passengers,  $m_{pax}$  and Mach in cruise. (Scholz 2021a).



## Appendix B – DOC Methods and Corresponding Organizations

**Table B.1** Overview of selected DOC methods and corresponding organizations (Scholz 2015)

Organization	Comment	Year of Publication	Source
Air Transport Association of America (ATA)	Predecessors to this method are from the year: 1944, 1949, 1955 and 1960.	1967	<b>ATA 1967</b>
American Airlines (AA)	The Method is based on Large Studies sponsored by NASA. See also: <b>NASA 1977</b> .	1980	<b>AA 1980</b>
Lufthansa	The Method was continuously developed further.	1982	<b>DLH 1982</b>
Association of European Airlines (AEA)	Method for Short- and Medium Range Aircraft	1989	<b>AEA 1989a</b>
Association of European Airlines (AEA)	Method for Long Range Aircraft (a modification of the method <b>AEA 1999a</b> )	1989	<b>AEA 1989b</b>
Airbus Industries (AI)	The Method was continuously developed further.	1989	<b>AI 1989</b>
Fokker	The Method was produced to evaluate aircraft design project.	1993	<b>Fokker 1993</b>

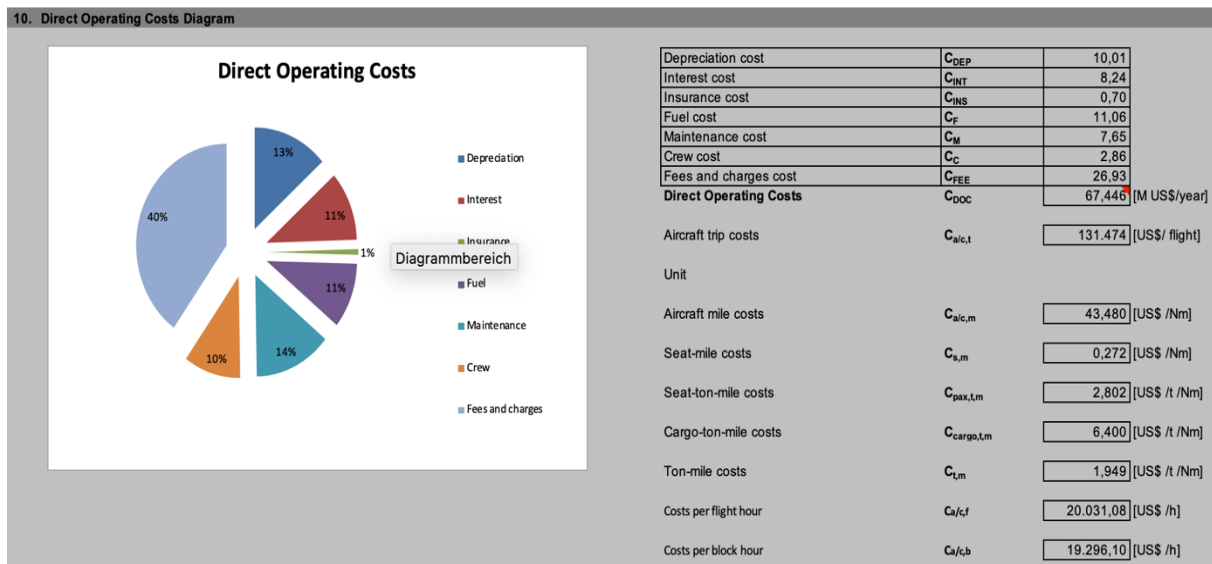
## Appendix C – Interface of the Tools Used for the DOC Calculation

**Direct Operating Costs**

1. Input data from previous design phases

Number of engines	$n_E$	<input type="text" value="2"/> [-]	Airframe mass	$m_{AF}$	<input type="text" value="46660"/> [kg]
Take-off thrust of ONE engine	$T_{TIOE}$	<input type="text" value="145,16"/> [kN]	Payload mass	$m_{PL}$	<input type="text" value="22314"/> [kg]
Max. Take-off mass	$m_{MTO}$	<input type="text" value="101000"/> [kg]	Baggage mass	$m_{Baggage}$	<input type="text" value="3520"/> [kg]
Operating empty mass	$m_{OE}$	<input type="text" value="52660"/> [kg]	Cargo mass	$m_{Cargo}$	<input type="text" value="6794"/> [kg]
Number of passengers	$n_{PAX}$	<input type="text" value="160"/> [-]	Passenger mass	$m_{PAX}$	<input type="text" value="12000"/> [kg]
Design range	$R$	<input type="text" value="8700"/> [km]	Fuel mass	$m_F$	<input type="text" value="22090"/> [kg]
Engines mass	$m_{E,inst}$	<input type="text" value="6000"/> [kg]			

**Figure C.1** Input for the PreSTo tool: aircraft masses, fuel mass, passenger mass, and take-off thrust (Scholz 2021b)



**Figure C.2** Output of the PreSTo tool: yearly DOC, DOC composition, and various cost interpretations, e.g., SKC (Scholz 2021b)

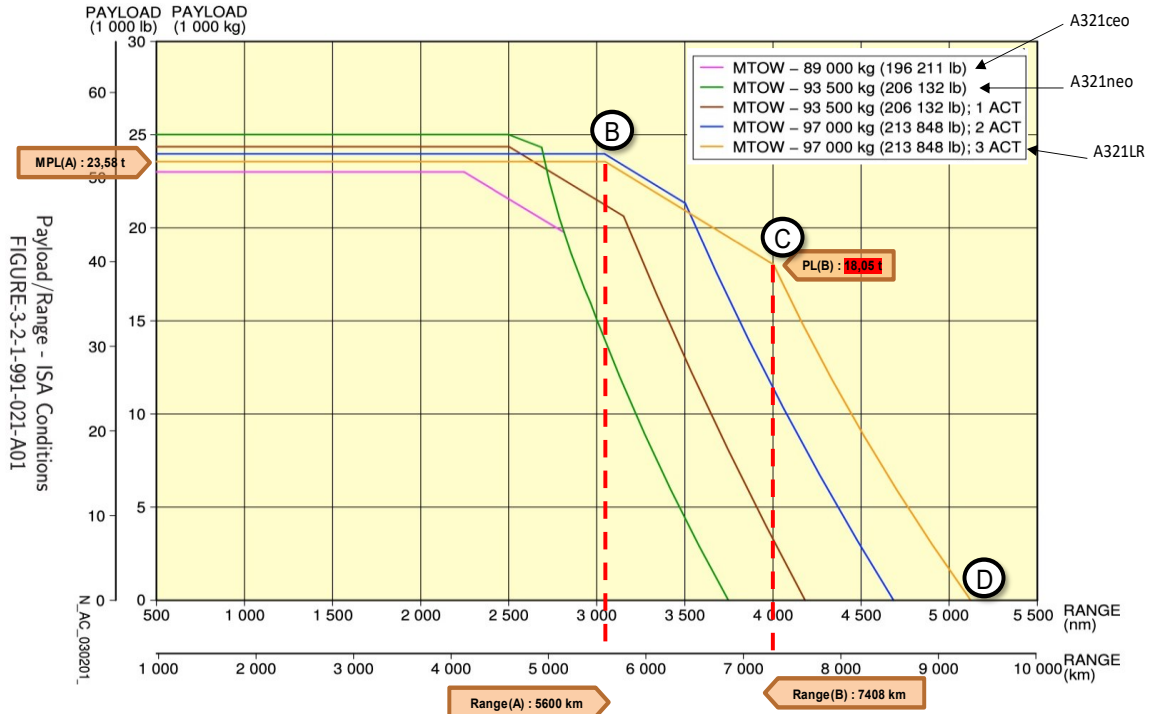
C_cap (yr)	6.929.174 €
P_ow	1150 €/kg
OEW	52.660 kg
W_eng	3.000 kg
N_eng	2
f_Ins	0,5%
a	0,096
P_eng	2500 €/kg
IR	5%
DP	14
f_RV	10%
Airframe Mass	46.660 kg
Airframe Costs	53.659.000 €
Engine Costs	15.000.000 €
Aircraft Costs	68.659.000 €
Capital Rate	0,1009
C_Crew	2.700.000 €
CC	5
S_FA	60.000 €/yr
S_FC(2 p)	300.000 €/yr
n_FA(200Pax)	4

**Figure C.3** Output of the own developed tool for the computation of the DOCs according to the TU Berlin DOC method: route-independent costs

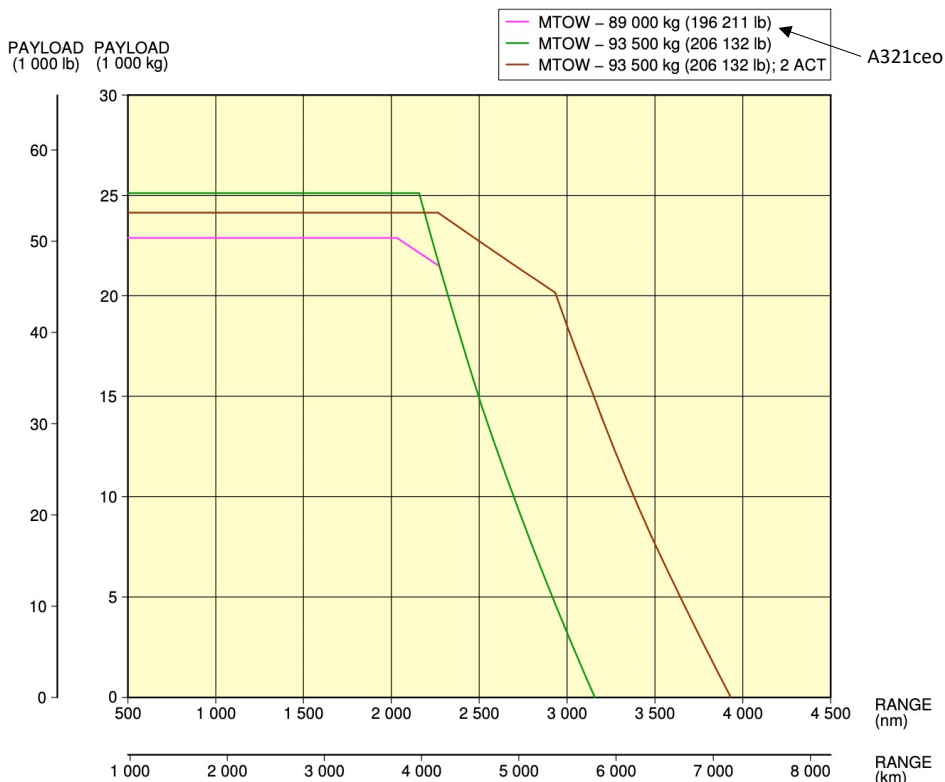
P_F	0,8 €/kg
TF	22.090 kg
P_PL	0,1 €/kg
PL	22.314 kg
P_L	0,01 €/kg
MTOW	101.000 kg
MTOW(to)	101
MZFW	74.374 kg
f(R)	0,7
R	5.600 km
Fuel Cost(flight)	17.672 €
Handling fees(flight)	2.231 €
Landing fees(flight)	1.010 €
ATC Cost(flight)	5.571 €
MC(flight)	2.608 €
C_2(flight)	29.093 €

**Figure C.4** Output of the own developed tool for the computation of the DOCs according to the TU Berlin DOC method: route-dependent costs

# Appendix D – Payload-Range Diagrams for the A321 Family and the A330-900neo



**Figure D.1** PRD for A321neo variants: MTOW, MPL, ranges (B, C, and D) – edited from Airbus (2020)



**Figure D.2** PRD for the A321-200 variants: MTOW, MPL, and ranges – edited from Airbus (2020)

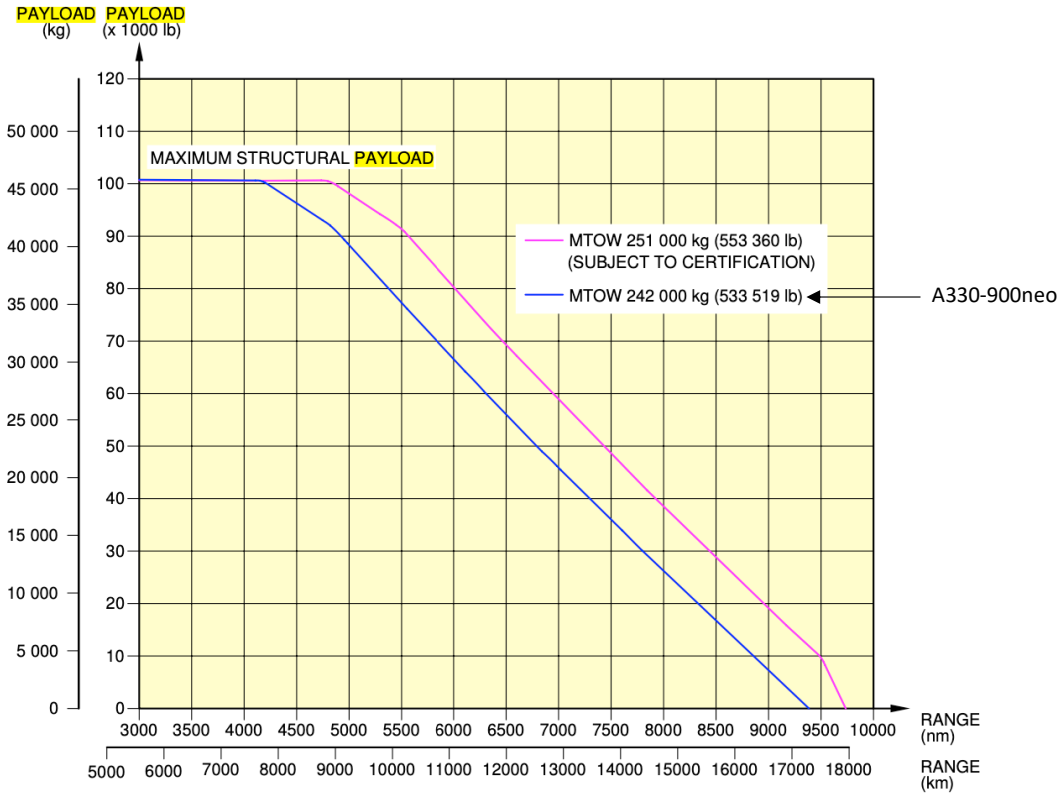


Figure D.3 PRD for the A330neo variants: MTOW, MPL, and ranges – edited from Airbus (2020)

## Appendix E – Overview of the Different A321neo Versions (neo and LR): MTOW, MZFW, and MFW

**Table E.1** Characteristics of A321neo variants: MTOW, MZFW – specific to each weight variant; edited from Airbus (2020)

Aircraft Characteristics							
	WV050	WV051	WV052	WV053	WV056	WV063	WV065
Maximum Ramp Weight (MRW) Maximum Taxi Weight (MTW)	89 400 kg (197 093 lb)	89 400 kg (197 093 lb)	93 900 kg (207 014 lb)	93 900 kg (207 014 lb)	92 900 kg (204 809 lb)	91 400 kg (201 502 lb)	90 900 kg (200 400 lb)
Maximum Take-Off Weight (MTOW)	89 000 kg (196 211 lb)	89 000 kg (196 211 lb)	93 500 kg (206 132 lb)	93 500 kg (206 132 lb)	92 500 kg (203 928 lb)	91 000 kg (200 621 lb)	90 500 kg (199 518 lb)
Maximum Landing Weight (MLW)	77 300 kg (170 417 lb)	79 200 kg (174 606 lb)	77 300 kg (170 417 lb)	79 200 kg (174 606 lb)	77 300 kg (170 417 lb)	79 200 kg (174 606 lb)	79 200 kg (174 606 lb)
Maximum Zero Fuel Weight (MZFW)	73 300 kg (161 599 lb)	75 600 kg (166 669 lb)	73 300 kg (161 599 lb)	75 600 kg (166 669 lb)	73 300 kg (161 599 lb)	75 600 kg (166 669 lb)	75 600 kg (166 669 lb)

Aircraft Characteristics				
	WV070	WV071 (ACF)	WV072 (ACF)	WV080
Maximum Ramp Weight (MRW) Maximum Taxi Weight (MTW)	80 400 kg (177 252 lb)	97 400 kg (214 730 lb)	97 400 kg (214 730 lb)	95 400 kg (210 321 lb)
Maximum Take-Off Weight (MTOW)	80 000 kg (176 370 lb)	97 000 kg (213 848 lb)	97 000 kg (213 848 lb)	95 000 kg (209 439 lb)
Maximum Landing Weight (MLW)	71 500 kg (157 630 lb)	77 300 kg (170 417 lb)	79 200 kg (174 606 lb)	79 200 kg (174 606 lb)
Maximum Zero Fuel Weight (MZFW)	67 000 kg (147 710 lb)	73 300 kg (161 599 lb)	75 600 kg (166 669 lb)	75 600 kg (166 669 lb)

**Table E.2** Characteristics of the A321-100, A321-200 and A321neo variants: ACTs and MFW – common to each weight variant ; edited from Airbus (2020)

Aircraft Characteristics					
Usable Fuel Capacity (density = 0.785 kg/l)	23 700 l - 26 692 l * - 29 684 l ** (6 261 US gal - 7 051 US gal * - 7 842 US gal **)				
		A321CEO CFMI	A321CEO IAE	A321NEO	
	ACT	2992 l (790 US gal)			3121 l (824 US gal)
	Basic Aircraft	24050 l (6353 US gal)	23700 l (6261 US gal)	23490 l (6205 US gal)	
	With 1 ACT	27042 l (7144 US gal)	26692 l (7051 US gal)	26482 l (6996 US gal)	26611 l (7030 US gal)
	With 2 ACTs	30034 l (7934 US gal)	29684 l (7842 US gal)	29474 l (7786 US gal)	29782 l (7868 US gal)
	With 3 ACTs (applicable only for ACF)	X	X	X	32853 l*** (8679 US gal***)

## Appendix F – Estimates for the A321XLR

The following data is so far known about the A321XLR (Airbus 2019c):

- MTOW – 101.000 kg;
- MFW – 31.016 kg with one installed RCT (12.900 l) and one optional ACT (2992 l), meaning a total of 39.511 liters starting from the base neo version (Airbus 2019c and Samson 2019);
- Range at MFW (point C) – 8.700 km;
- By equipping the aircraft with an extra RCT and the belonging structure, the MZFW has to be increased, thus resulting in a reduced MPL.

Furthermore, the changes regarding MZFW, OEW, and MPL that occurred from the neo to the LR were analyzed and transferred to the LR. The information gained was inputted in the fuel consumption calculation tool (Scholz 2021a), and the following PRD for the XLR was generated.

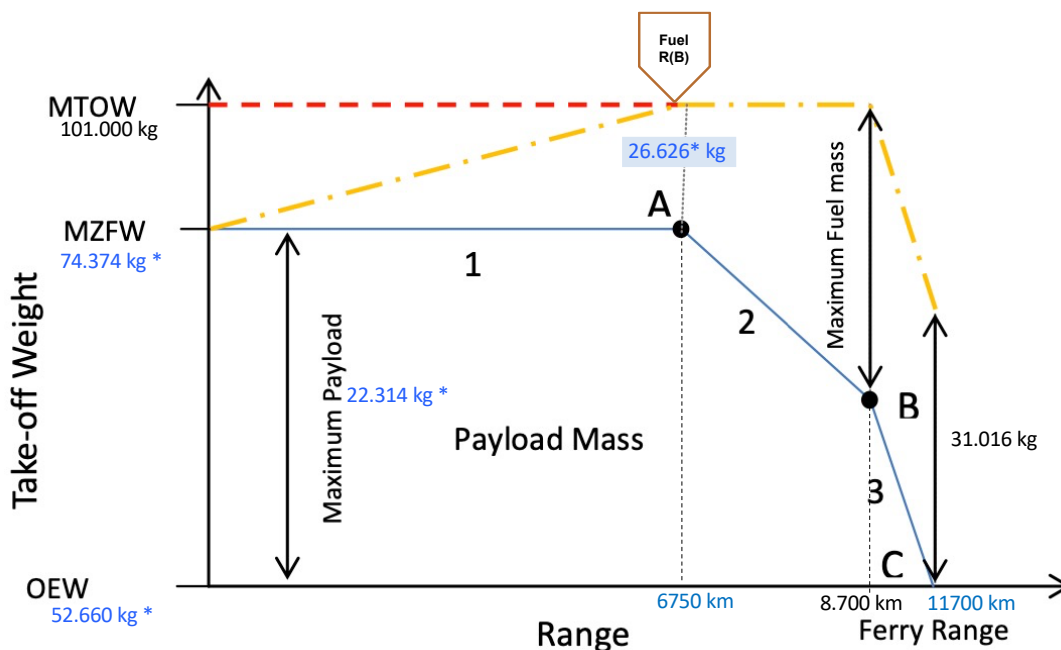
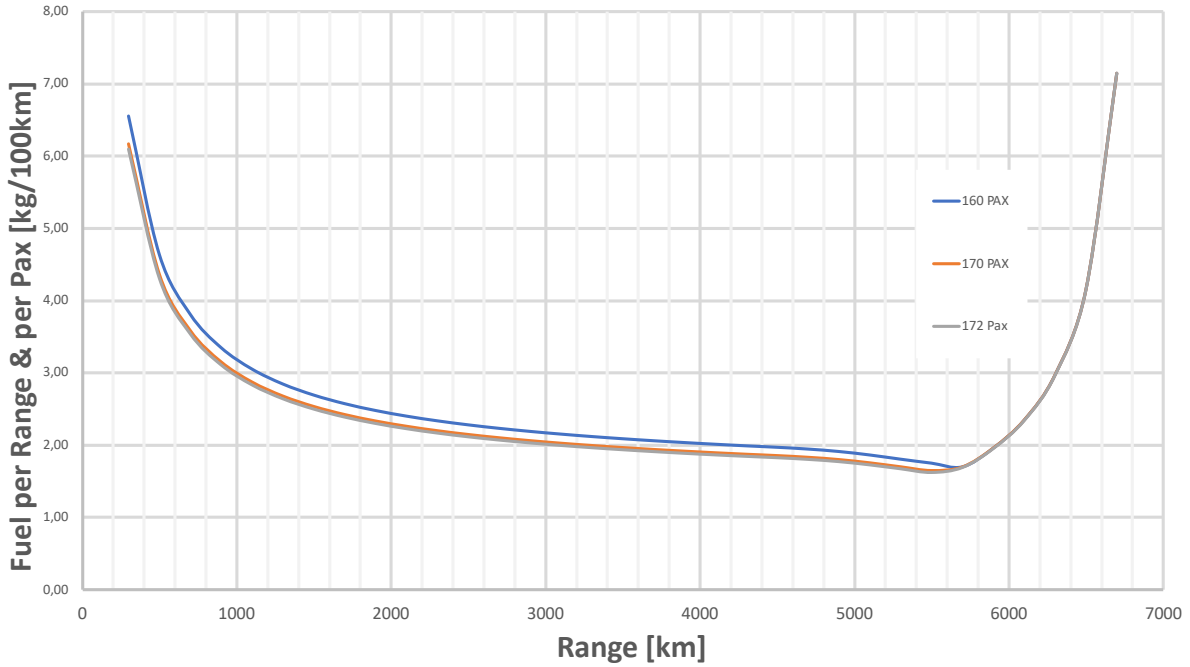


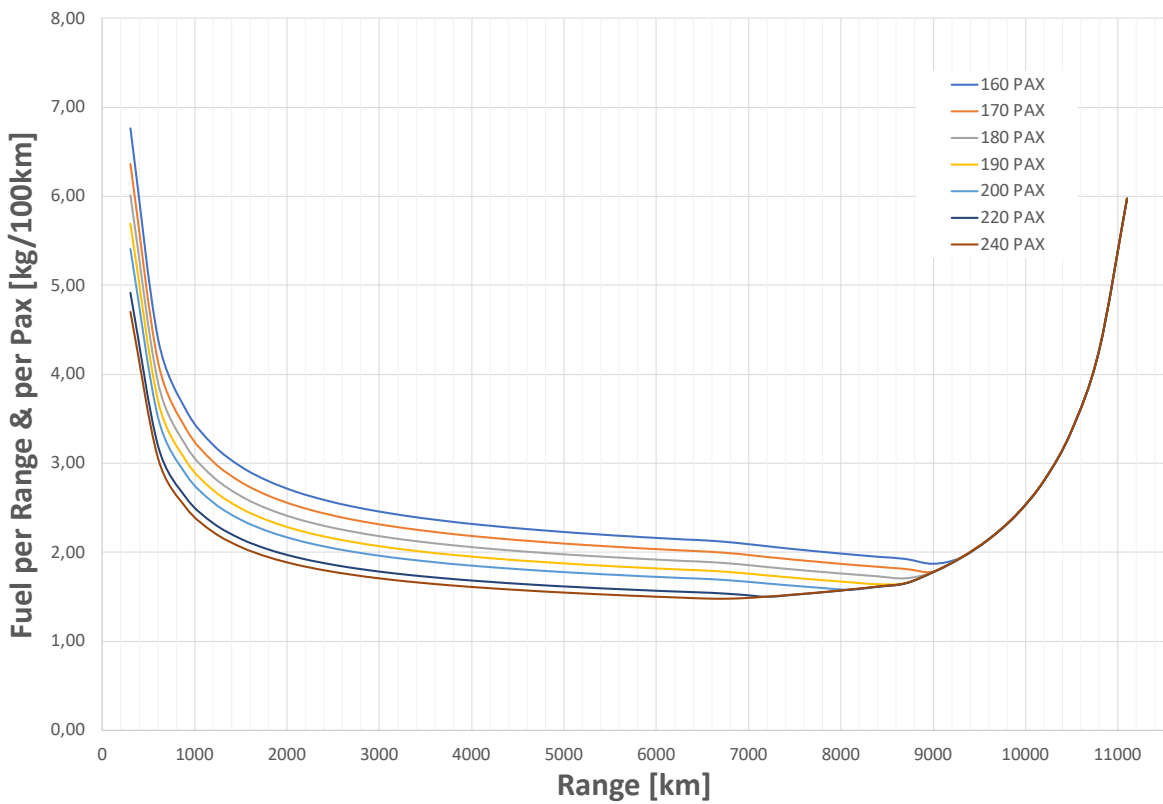
Figure F.1 Estimated PRD for the Airbus A321XLR; edited from Airbus (2020)

**Note:** The OEW was corrected afterwards, following iterations of the tool. Otherwise the MFW would be incorrect. Therefore there is a delta between the MPL expected from MZFW - OEW and the suggested one by the iterations – 600 kg. This difference is negligible and can be explained by the fact, that the total weight of the RCT system or eventual structure reinforcements can not be precisely ascertained (without the corresponding ACAMP).

## Appendix G – Fuel Consumption of the Aircraft used for Comparison

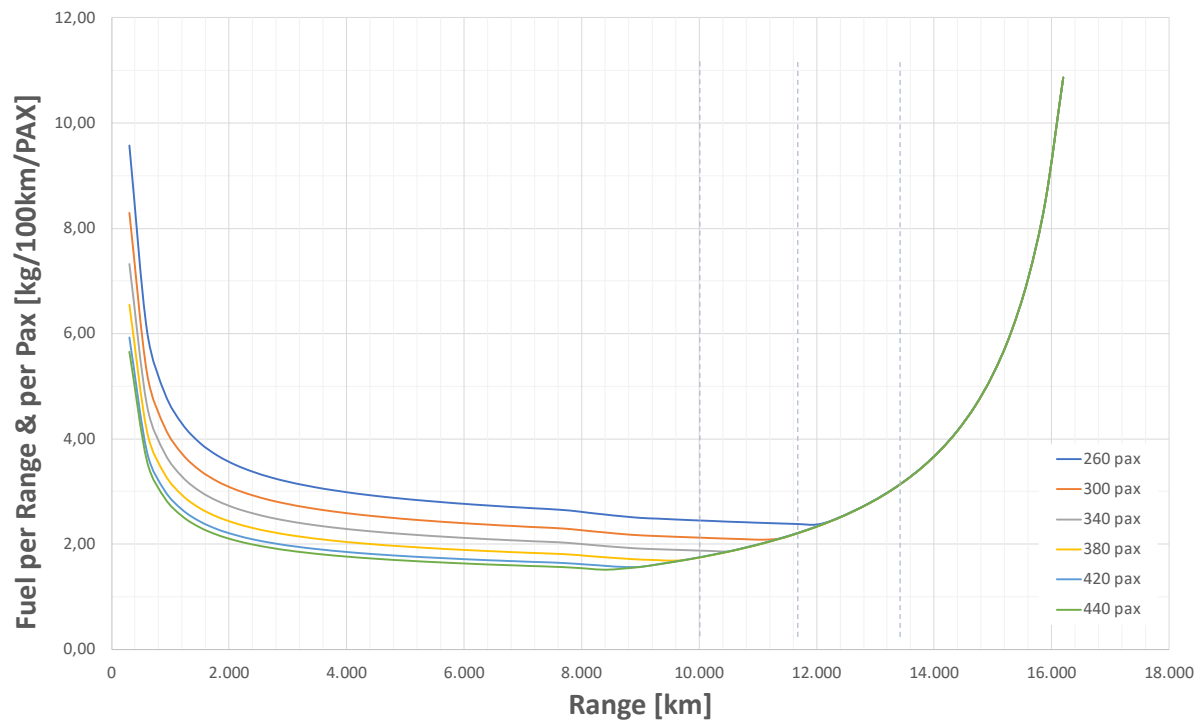


**Figure G.1** Fuel consumption per range and passenger over the flown distance for the A321neo – Bathtub Curve



**Figure G.2** Fuel consumption per range and passenger over flown the distance for the A321XLR – Bathtub Curve





**Figure G.3** Fuel consumption per range and passenger over the flown distance for the A330-900neo – Bathtub Curve

## Appendix H – Summary of the DOCs: All Missions

**Table H.1** DOC overview for all missions: TUB method, standard cabin with add. cargo

Mission	M1 - 5600 km			M2 - 6500 km			M3 - 7400 km		
	A321LR (200)	A321XLR (200)	A330-9neo (380)	A321LR (200)	A321XLR (200)	A330-9neo (380)	A321LR (186)*	A321XLR (200)	A330-9neo (380)
DOC [M US\$/year]	36,45	37,05	76,34	35,83	37,45	76,82	35,12	36,78	77,21
CCAPITAL [M US\$/year]	8,37	8,45	21,23	8,37	8,45	21,23	8,37	8,45	21,23
CHANDLING [M US\$/year]	2,05	1,94	4,15	1,62	1,73	3,69	1,26	1,41	3,33
CLANDING [M US\$/year]	0,84	0,88	2,18	0,75	0,78	1,94	0,67	0,70	1,75
CATC [M US\$/year]	4,75	4,85	7,78	4,93	5,03	8,04	5,02	5,12	8,24
CCREW [M US\$/year]	3,29	3,29	4,76	3,29	3,29	4,76	3,29	3,29	4,76
CMAINT [M US\$/year]	2,25	2,27	4,27	2,21	2,22	4,12	2,17	2,18	4,00
CFUEL [M US\$/year]	14,89	15,37	31,97	14,67	15,94	33,04	14,35	15,63	33,90
Aircraft trip costs [US\$/ flight]	51.122	51.969	103.301	56.255	58.796	116.751	61.618	64.530	130.201
Aircraft mile costs [US\$/ nm]	16,91	17,19	34,16	16,03	16,75	33,26	15,42	16,15	32,59
Aircraft kilometer costs [US\$/ km]	9,13	9,28	18,45	8,65	9,05	17,96	8,33	8,72	17,59
Seat-mile costs [US\$/ nm]	0,085	0,086	0,090	0,080	0,084	0,088	0,083	0,081	0,086
Seat kilometer costs [US\$/ km]	0,046	0,046	0,049	0,043	0,045	0,047	0,045	0,044	0,046
Costs per flight hour [US\$/ h]	7.746	7.874	16.397	7.402	7.736	15.993	7.083	7.417	15.687
Costs per block hour [US\$/ h]	6.064	6.165	12.706	5.966	6.235	12.788	5.852	6.128	12.853

**Table H.2** DOC overview for all missions: TUB method, standard cabin without add. cargo

Mission	M1 - 5600 km			M2 - 6500 km			M3 - 7400 km		
	A321LR (200)	A321XLR (200)	A330-9neo (380)	A321LR (200)	A321XLR (200)	A330-9neo (380)	A321LR (186)*	A321XLR (200)	A330-9neo (380)
DOC [M US\$/year]	35,27	36,20	73,91	35,44	36,61	74,43	35,12	36,54	74,84
CCAPITAL [M US\$/year]	8,37	8,45	21,23	8,37	8,45	21,23	8,37	8,45	21,23
CHANDLING [M US\$/year]	1,69	1,69	3,32	1,51	1,51	2,96	1,25	1,35	2,67
CLANDING [M US\$/year]	0,84	0,88	2,18	0,75	0,78	1,94	0,67	0,70	1,75
CATC [M US\$/year]	4,75	4,85	7,78	4,93	5,03	8,04	5,02	5,12	8,24
CCREW [M US\$/year]	3,29	3,29	4,76	3,29	3,29	4,76	3,29	3,29	4,76
CMAINT [M US\$/year]	2,25	2,27	4,27	2,21	2,22	4,12	2,17	2,18	4,00
CFUEL [M US\$/year]	14,08	14,77	30,36	14,39	15,32	31,38	14,35	15,44	32,19
Aircraft trip costs [US\$/ flight]	49.473	50.776	100.009	55.644	57.468	113.109	61.614	64.107	126.210
Aircraft mile costs [US\$/ nm]	16,36	16,79	33,07	15,85	16,37	32,23	15,42	16,04	31,59
Aircraft kilometer costs [US\$/ km]	8,83	9,07	17,86	8,56	8,84	17,40	8,33	8,66	17,06
Seat-mile costs [US\$/ nm]	0,082	0,084	0,087	0,079	0,082	0,085	0,083	0,080	0,083
Seat kilometer costs [US\$/ km]	0,044	0,045	0,047	0,043	0,044	0,046	0,045	0,043	0,045
Costs per flight hour [US\$/ h]	7.496	7.693	15.874	7.322	7.562	15.494	7.082	7.369	15.206
Costs per block hour [US\$/ h]	5.869	6.023	12.301	5.901	6.094	12.389	5.851	6.088	12.459

**Table H.3** DOC overview for all Missions: TUB method, high-density cabin with add. cargo

Mission	M1 - 5600 km			M2 - 6500 km			M3 - 7400 km		
	A321LR (220)	A321XLR (220)	A330-9neo (420)	A321LR (214)*	A321XLR (220)	A330-9neo (420)	A321LR (186)*	A321XLR (208)*	A330-9neo (420)
DOC [M US\$/year]	36,82	37,42	76,71	36,20	37,82	77,19	35,12	37,15	77,58
CCAPITAL [M US\$/year]	8,37	8,45	21,23	8,37	8,45	21,23	8,37	8,45	21,23
CHANDLING [M US\$/year]	2,05	1,94	4,15	1,62	1,73	3,69	1,26	1,41	3,33
CLANDING [M US\$/year]	0,84	0,88	2,18	0,75	0,78	1,94	0,67	0,70	1,75
CATC [M US\$/year]	4,75	4,85	7,78	4,93	5,03	8,04	5,02	5,12	8,24
CCREW [M US\$/year]	3,66	3,66	5,12	3,66	3,66	5,12	3,29	3,66	5,12
CMAINT [M US\$/year]	2,25	2,27	4,27	2,21	2,22	4,12	2,17	2,18	4,00
CFUEL [M US\$/year]	14,89	15,37	31,97	14,67	15,94	33,04	14,35	15,63	33,90
Aircraft trip costs [US\$/ flight]	51.636	52.483	103.796	56.829	59.371	117.307	61.618	65.173	130.819
Aircraft mile costs [US\$/ nm]	17,08	17,36	34,33	16,19	16,92	33,42	15,42	16,31	32,74
Aircraft kilometer costs [US\$/ km]	9,22	9,37	18,53	8,74	9,13	18,05	8,33	8,81	17,68
Seat-mile costs [US\$/ nm]	0,078	0,079	0,082	0,076	0,077	0,080	0,083	0,078	0,078
Seat kilometer costs [US\$/ km]	0,042	0,043	0,044	0,041	0,042	0,043	0,045	0,042	0,042
Costs per flight hour [US\$/ h]	7.824	7.952	16.476	7.478	7.812	16.069	7.083	7.491	15.761
Costs per block hour [US\$/ h]	6.125	6.226	12.767	6.026	6.296	12.848	5.852	6.189	12.914

**Table H.4** DOC overview for all missions: TUB method, high-Density cabin without add. aargo

Mission	M1 - 5600 km			M2 - 6500 km			M3 - 7400 km		
	A321LR (220)	A321XLR (220)	A330-9neo (420)	A321LR (214)*	A321XLR (220)	A330-9neo (420)	A321LR (186)*	A321XLR (208)*	A330-9neo (420)
DOC [M US\$/year]	36,19	37,14	75,31	36,19	37,54	75,81	35,12	37,13	76,21
CCAPITAL [M US\$/year]	8,37	8,45	21,23	8,37	8,45	21,23	8,37	8,45	21,23
CHANDLING [M US\$/year]	1,86	1,86	3,67	1,61	1,66	3,27	1,25	1,40	2,95
CLANDING [M US\$/year]	0,84	0,88	2,18	0,75	0,78	1,94	0,67	0,70	1,75
CATC [M US\$/year]	4,75	4,85	7,78	4,93	5,03	8,04	5,02	5,12	8,24
CCREW [M US\$/year]	3,66	3,66	5,12	3,66	3,66	5,12	3,29	3,66	5,12
CMAINT [M US\$/year]	2,25	2,27	4,27	2,21	2,22	4,12	2,17	2,18	4,00
CFUEL [M US\$/year]	14,46	15,17	31,04	14,66	15,73	32,08	14,35	15,61	32,92
Aircraft trip costs [US\$/ flight]	50.759	52.084	101.902	56.813	58.927	115.211	61.614	65.135	128.522
Aircraft mile costs [US\$/ nm]	16,79	17,22	33,70	16,19	16,79	32,83	15,42	16,30	32,17
Aircraft kilometer costs [US\$/ km]	9,06	9,30	18,20	8,74	9,07	17,72	8,33	8,80	17,37
Seat-mile costs [US\$/ nm]	0,076	0,078	0,080	0,076	0,076	0,078	0,083	0,078	0,077
Seat kilometer costs [US\$/ km]	0,041	0,042	0,043	0,041	0,041	0,042	0,045	0,042	0,041
Costs per flight hour [US\$/ h]	7.691	7.891	16.175	7.475	7.754	15.782	7.082	7.487	15.485
Costs per block hour [US\$/ h]	6.021	6.178	12.534	6.025	6.249	12.619	5.851	6.186	12.687

**Table H.5** DOC overview for all missions:TUB method, low-density cabin with add. cargo

Mission	M1 - 5600 km					M2 - 6500 km			M3 - 7400 km		
	A321ceo (36)	A321neo (172)	A321LR (180)	A321XLR (180)	A330-9neo (340)	A321LR (180)	A321XLR (180)	A330-9neo (340)	A321LR (180)	A321XLR (180)	A330-9neo (340)
DOC [M US\$/year]	29,91	33,47	36,45	37,05	75,97	35,83	37,45	76,46	35,12	36,78	76,84
CCAPITAL [M US\$/year]	7,86	8,19	8,37	8,45	21,23	8,37	8,45	21,23	8,37	8,45	21,23
CHANDLING [M US\$/year]	0,29	1,46	2,05	1,94	4,15	1,62	1,73	3,69	1,26	1,41	3,33
CLANDING [M US\$/year]	0,74	0,81	0,84	0,88	2,18	0,75	0,78	1,94	0,67	0,70	1,75
CATC [M US\$/year]	4,34	4,66	4,75	4,85	7,78	4,93	5,03	8,04	5,02	5,12	8,24
CCREW [M US\$/year]	2,20	3,29	3,29	3,29	4,39	3,29	3,29	4,39	3,29	3,29	4,39
CMAINT [M US\$/year]	2,15	2,23	2,25	2,27	4,27	2,21	2,22	4,12	2,17	2,18	4,00
CFUEL [M US\$/year]	12,34	12,83	14,89	15,37	31,97	14,67	15,94	33,04	14,35	15,63	33,90
Aircraft trip costs [US\$/flight]	43.990	46.946	51.122	51.969	102.805	56.255	58.796	116.194	61.618	64.530	129.584
Aircraft mile costs [US\$/nm]	14,55	15,53	16,91	17,19	34,00	16,03	16,75	33,11	15,42	16,15	32,43
Aircraft kilometer costs [US\$/km]	7,86	8,38	9,13	9,28	18,36	8,65	9,05	17,88	8,33	8,72	17,51
Seat-mile costs [US\$/nm]	0,404	0,090	0,094	0,095	0,100	0,089	0,093	0,097	0,086	0,090	0,095
Seat kilometer costs [US\$/km]	0,218	0,049	0,051	0,052	0,054	0,048	0,050	0,053	0,046	0,048	0,052
Costs per flight hour [US\$/h]	6.284	7.113	7.746	7.874	16.318	7.402	7.736	15.917	7.083	7.417	15.613
Costs per block hour [US\$/h]	4.982	5.569	6.064	6.165	12.645	5.966	6.235	12.727	5.852	6.128	12.792

**Table H.6** DOC overview for all Missions: TUB method, low-density cabin without add. cargo

Mission	M1 - 5600 km					M2 - 6500 km			M3 - 7400 km		
	A321ceo (36)	A321neo (172)*	A321LR (180)	A321XLR (180)	A330-9neo (340)	A321LR (180)	A321XLR (180)	A330-9neo (340)	A321LR (180)	A321XLR (180)	A330-9neo (340)
DOC [M US\$/year]	29,91	33,45	34,72	35,64	72,51	34,90	36,04	73,04	34,96	35,99	73,47
CCAPITAL [M US\$/year]	7,86	8,19	8,37	8,45	21,23	8,37	8,45	21,23	8,37	8,45	21,23
CHANDLING [M US\$/year]	0,29	1,45	1,52	1,52	2,97	1,36	1,36	2,65	1,21	1,21	2,39
CLANDING [M US\$/year]	0,74	0,81	0,84	0,88	2,18	0,75	0,78	1,94	0,67	0,70	1,75
CATC [M US\$/year]	4,34	4,66	4,75	4,85	7,78	4,93	5,03	8,04	5,02	5,12	8,24
CCREW [M US\$/year]	2,20	3,29	3,29	3,29	4,39	3,29	3,29	4,39	3,29	3,29	4,39
CMAINT [M US\$/year]	2,15	2,23	2,25	2,27	4,27	2,21	2,22	4,12	2,17	2,18	4,00
CFUEL [M US\$/year]	12,34	12,82	13,69	14,38	29,68	14,00	14,91	30,67	14,23	15,03	31,47
Aircraft trip costs [US\$/flight]	43.990	46.914	48.701	49.981	98.116	54.794	56.584	111.007	61.334	63.141	123.898
Aircraft mile costs [US\$/nm]	14,55	15,52	16,11	16,53	32,45	15,61	16,12	31,63	15,35	15,80	31,01
Aircraft kilometer costs [US\$/km]	7,86	8,38	8,70	8,93	17,52	8,43	8,71	17,08	8,29	8,53	16,74
Seat-mile costs [US\$/nm]	0,404	0,090	0,089	0,092	0,095	0,087	0,090	0,093	0,085	0,088	0,091
Seat kilometer costs [US\$/km]	0,218	0,049	0,048	0,050	0,052	0,047	0,048	0,050	0,046	0,047	0,049
Costs per flight hour [US\$/h]	6.284	7.108	7.379	7.573	15.574	7.210	7.445	15.206	7.050	7.258	14.928
Costs per block hour [US\$/h]	4.982	5.565	5.777	5.929	12.068	5.811	6.000	12.158	5.825	5.996	12.231

**Table H.7** DOC overview for all missions: AEA method, standard cabin with add. cargo

Mission	M1 - 5600 km			M2 - 6500 km			M3 - 7400 km		
	A321LR (200)	A321XLR (200)	A330-9neo (380)	A321LR (200)	A321XLR (200)	A330-9neo (380)	A321LR (186)*	A321XLR (200)	A330-9neo (380)
DOC [M US\$/year]	66,47	67,45	132,66	63,71	66,28	130,02	61,74	64,19	127,98
CCREW [M US\$/year]	2,86	2,86	3,97	2,88	2,88	4,01	2,90	2,90	4,04
CMAINT [M US\$/year]	7,63	7,65	14,85	7,49	7,57	14,71	7,50	7,53	14,60
CFUEL [M US\$/year]	10,71	11,06	23,10	10,32	11,21	23,45	10,02	1,00	2,00
CDEPRECIATION [M]	9,66	10,01	21,17	9,66	10,01	21,17	9,66	10,01	21,17
CINTEREST [M US\$/year]	7,95	8,24	17,42	7,95	8,24	17,42	7,95	8,24	17,42
CINSURANCE [M US\$/year]	0,68	0,70	1,48	0,68	0,70	1,48	0,68	0,70	1,48
CFEES [M US\$/year]	26,99	26,93	50,66	24,74	25,67	47,77	23,03	24,47	45,53

Aircraft trip costs [US\$/ flight]	129.580	131.474	248.424	142.211	147.952	278.407	155.119	161.281	308.375
Aircraft mile costs [US\$/ nm]	42,85	43,48	82,16	40,52	42,15	79,32	38,82	40,36	77,18
Aircraft kilometer costs [US\$/ km]	23,14	23,48	44,36	21,88	22,76	42,83	20,96	21,79	41,67
Seat-mile costs [US\$/ nm]	0,214	0,217	0,216	0,203	0,211	0,209	0,209	0,202	0,203
Seat kilometer costs [US\$/ km]	0,116	0,117	0,117	0,109	0,114	0,113	0,113	0,109	0,110
Costs per flight hour [US\$/ h]	19.742	20.031	39.606	18.667	19.420	38.240	17.885	18.595	37.205
Costs per block hour [US\$/ h]	19.018	19.296	38.088	18.074	18.803	36.971	17.384	18.074	36.116

**Table H.8** DOC overview for all missions: AEA method, standard Density without add. Cargo

Mission	M1 - 5600 km			M2 - 6500 km			M3 - 7400 km		
	A321LR (200)	A321XLR (200)	A330-9neo (380)	A321LR (200)	A321XLR (200)	A330-9neo (380)	A321LR (186)*	A321XLR (200)	A330-9neo (380)
DOC [M US\$/year]	64,21	65,90	127,83	63,11	64,87	125,14	61,73	63,10	123,94
CCREW [M US\$/year]	2,86	2,86	3,97	2,88	2,88	4,01	2,90	2,90	4,04
CMAINT [M US\$/year]	7,56	7,65	14,85	7,55	7,57	14,68	7,50	7,53	14,60
CFUEL [M US\$/year]	10,13	10,63	21,94	10,12	1,00	2,00	10,02	1,00	2,00
CDEPRECIATION [M]	9,66	10,01	21,17	9,66	10,01	21,17	9,66	10,01	21,17
CINTEREST [M US\$/year]	7,95	8,24	17,42	7,95	8,24	17,42	7,95	8,24	17,42
CINSURANCE [M US\$/year]	0,68	0,70	1,48	0,68	0,70	1,48	0,68	0,70	1,48
CFEES [M US\$/year]	25,38	25,81	47,00	24,27	24,69	44,57	23,03	23,84	42,69

Aircraft trip costs [US\$/ flight]	125.172	128.450	239.390	140.869	144.793	267.961	155.110	158.552	298.641
Aircraft mile costs [US\$/ nm]	41,40	42,48	79,17	40,14	41,25	76,35	38,82	39,68	74,74
Aircraft kilometer costs [US\$/ km]	22,35	22,94	42,75	21,67	22,28	41,22	20,96	21,43	40,36
Seat-mile costs [US\$/ nm]	0,207	0,212	0,208	0,201	0,206	0,201	0,209	0,198	0,197
Seat kilometer costs [US\$/ km]	0,112	0,115	0,112	0,108	0,111	0,108	0,113	0,107	0,106
Costs per flight hour [US\$/ h]	19.071	19.570	38.166	18.491	19.006	36.805	17.884	18.281	36.031
Costs per block hour [US\$/ h]	18.371	18.852	36.703	17.903	18.402	35.584	17.383	17.768	34.976

**Table H.9** DOC overview for all missions: AEA method, high-density cabin with add. cargo

Mission	M1 - 5600 km			M2 - 6500 km			M3 - 7400 km		
	A321LR (220)	A321XLR (220)	A330-9neo (420)	A321LR (214)*	A321XLR (220)	A330-9neo (420)	A321LR (186)*	A321XLR (208)*	A330-9neo (420)
DOC [M US\$/year]	66,68	67,73	132,94	64,00	66,57	130,30	61,74	64,67	128,26
CCREW [M US\$/year]	3,14	3,14	4,26	3,17	2,88	4,30	2,90	3,19	4,33
CMAINT [M US\$/year]	7,56	7,65	14,85	7,49	7,57	14,71	7,50	7,52	14,60
CFUEL [M US\$/year]	10,71	11,06	23,10	10,32	11,21	23,45	10,02	10,91	23,72
CDEPRECIATION [M]	9,66	10,01	21,17	9,66	10,01	21,17	9,66	10,01	21,17
CINTEREST [M US\$/year]	7,95	8,24	17,42	7,95	8,24	17,42	7,95	8,24	17,42
CINSURANCE [M US\$/year]	0,68	0,70	1,48	0,68	0,70	1,48	0,68	0,70	1,48
CFEES [M US\$/year]	26,98	26,93	50,66	24,74	25,67	47,77	23,03	24,10	45,53
Aircraft trip costs [US\$/ flight]	129.973	132.026	248.952	142.848	147.952	279.017	155.119	162.484	309.066
Aircraft mile costs [US\$/ nm]	42,98	43,66	82,33	40,70	42,15	79,50	38,82	40,66	77,35
Aircraft kilometer costs [US\$/ km]	23,21	23,58	44,46	21,98	22,76	42,93	20,96	21,96	41,77
Seat-mile costs [US\$/ nm]	0,195	0,198	0,196	0,190	0,192	0,189	0,209	0,196	0,184
Seat kilometer costs [US\$/ km]	0,105	0,107	0,106	0,103	0,104	0,102	0,113	0,106	0,099
Costs per flight hour [US\$/ h]	19.802	20.115	39.690	18.750	19.420	38.324	17.885	18.734	37.288
Costs per block hour [US\$/ h]	19.076	19.377	38.169	18.155	18.803	37.052	17.384	18.209	36.197

**Table H.10** DOC overview for all missions: AEA method, high-density cabin without add. cargo

Mission	M1 - 5600 km			M2 - 6500 km			M3 - 7400 km		
	A321LR (220)	A321XLR (220)	A330-9neo (420)	A321LR (214)*	A321XLR (220)	A330-9neo (420)	A321LR (186)*	A321XLR (208)*	A330-9neo (420)
DOC [M US\$/year]	65,52	67,21	130,16	64,04	66,09	127,38	61,73	64,21	125,94
CCREW [M US\$/year]	3,14	3,14	4,26	3,17	3,17	4,30	2,90	3,19	4,33
CMAINT [M US\$/year]	7,56	7,65	14,85	7,55	7,57	14,71	7,50	7,48	14,60
CFUEL [M US\$/year]	10,40	10,92	22,43	10,31	11,07	22,37	10,02	10,52	23,04
CDEPRECIATION [M]	9,66	10,01	21,17	9,66	10,01	21,17	9,66	10,01	21,17
CINTEREST [M US\$/year]	7,95	8,24	17,42	7,95	8,24	17,42	7,95	8,24	17,42
CINSURANCE [M US\$/year]	0,68	0,70	1,48	0,68	0,70	1,48	0,68	0,70	1,48
CFEES [M US\$/year]	26,13	26,56	48,55	24,73	25,34	45,93	23,03	24,07	43,90
Aircraft trip costs [US\$/ flight]	127.715	131.016	243.754	142.948	147.533	272.769	155.110	161.341	303.465
Aircraft mile costs [US\$/ nm]	42,24	43,33	80,61	40,73	42,04	77,72	38,82	40,38	75,95
Aircraft kilometer costs [US\$/ km]	22,81	23,40	43,53	21,99	22,70	41,96	20,96	21,80	41,01
Seat-mile costs [US\$/ nm]	0,192	0,197	0,192	0,190	0,191	0,185	0,209	0,194	0,181
Seat kilometer costs [US\$/ km]	0,104	0,106	0,104	0,103	0,103	0,100	0,113	0,105	0,098
Costs per flight hour [US\$/ h]	19.458	19.961	38.861	18.764	19.365	37.466	17.884	18.602	36.613
Costs per block hour [US\$/ h]	18.744	19.229	37.372	18.167	18.750	36.222	17.383	18.081	35.541

**Table H.11** DOC overview for all missions: AEA method, low-density cabin with add. cargo

Mission	M1 - 5600 km					M2 - 6500 km			M3 - 7400 km		
	A321ceo (36)	A321neo (172)	A321LR (180)	A321XLR (180)	A330-9neo (340)	A321LR (180)	A321XLR (180)	A330-9neo (340)	A321LR (180)	A321XLR (180)	A330-9neo (340)
DOC [M US\$/year]	51,94	61,06	66,39	67,45	132,38	63,71	66,28	129,73	61,67	64,19	127,69
CCREW [M US\$/year]	2,01	2,86	2,86	2,86	3,69	2,88	2,88	3,73	2,90	2,90	3,76
CMAINT [M US\$/year]	7,12	7,43	7,56	7,65	14,85	7,49	7,57	14,71	7,44	7,53	14,60
CFUEL [M US\$/year]	8,84	9,23	10,71	11,06	23,10	10,32	11,21	23,45	10,02	10,33	23,72
CDEPRECIATION [M]	8,48	9,27	9,66	10,01	21,17	9,66	10,01	21,17	9,66	10,01	21,17
CINTEREST [M US\$/year]	6,97	7,63	7,95	8,24	17,42	7,95	8,24	17,42	7,95	8,24	17,42
CINSURANCE [M US\$/year]	0,59	0,65	0,68	0,70	1,48	0,68	0,70	1,48	0,68	0,70	1,48
CFEES [M US\$/year]	17,93	23,99	26,98	26,93	50,66	24,74	25,67	47,77	23,03	24,47	45,53
Aircraft trip costs [US\$/flight]	106.653	119.025	129.422	131.474	247.896	142.211	147.952	277.797	154.955	161.281	307.683
Aircraft mile costs [US\$/nm]	35,27	39,36	42,80	43,48	81,98	40,52	42,15	79,15	38,78	40,36	77,00
Aircraft kilometer costs [US\$/km]	19,05	21,25	23,11	23,48	44,27	21,88	22,76	42,74	20,94	21,79	41,58
Seat-mile costs [US\$/nm]	0,980	0,229	0,238	0,240	0,241	0,225	0,234	0,233	0,215	0,225	0,226
Seat kilometer costs [US\$/km]	0,529	0,124	0,128	0,130	0,130	0,122	0,126	0,126	0,116	0,121	0,122
Costs per flight hour [US\$/h]	15.358	18.134	19.718	20.031	39.522	18.667	19.420	38.156	17.866	18.595	37.122
Costs per block hour [US\$/h]	14.824	17.469	18.995	19.296	38.007	18.074	18.803	36.890	17.365	18.074	36.035

**Table H.12** DOC overview for all missions: AEA method, low-density cabin without add. cargo

Mission	M1 - 5600 km					M2 - 6500 km			M3 - 7400 km		
	A321ceo (36)	A321neo (172)	A321LR (180)	A321XLR (180)	A330-9neo (340)	A321LR (180)	A321XLR (180)	A330-9neo (340)	A321LR (180)	A321XLR (180)	A330-9neo (340)
DOC [M US\$/year]	51,47	61,02	63,19	64,86	125,50	62,19	63,28	123,11	61,48	62,26	121,93
CCREW [M US\$/year]	2,01	2,86	2,86	2,86	3,69	2,88	2,88	3,73	2,90	2,90	3,76
CMAINT [M US\$/year]	7,12	7,43	7,56	7,65	14,85	7,55	7,59	14,71	7,50	7,53	14,60
CFUEL [M US\$/year]	8,84	9,22	9,85	10,34	21,44	9,85	9,82	21,39	9,94	9,61	22,02
CDEPRECIATION [M]	8,48	9,27	9,66	10,01	21,17	9,66	10,01	21,17	9,66	10,01	21,17
CINTEREST [M US\$/year]	6,97	7,63	7,95	8,24	17,42	7,95	8,24	17,42	7,95	8,24	17,42
CINSURANCE [M US\$/year]	0,59	0,65	0,68	0,70	1,48	0,68	0,70	1,48	0,68	0,70	1,48
CFEES [M US\$/year]	17,46	23,96	24,64	25,06	45,45	23,62	24,04	43,21	22,86	23,26	41,48
Aircraft trip costs [US\$/flight]	105.690	118.941	123.180	126.437	235.027	138.810	141.246	263.620	154.468	156.431	293.818
Aircraft mile costs [US\$/nm]	34,95	39,34	40,74	41,81	77,73	39,55	40,24	75,11	38,66	39,15	73,53
Aircraft kilometer costs [US\$/km]	18,87	21,24	22,00	22,58	41,97	21,36	21,73	40,56	20,87	21,14	39,71
Seat-mile costs [US\$/nm]	0,971	0,229	0,226	0,232	0,229	0,220	0,224	0,221	0,215	0,217	0,216
Seat kilometer costs [US\$/km]	0,524	0,123	0,122	0,125	0,123	0,119	0,121	0,119	0,116	0,117	0,117
Costs per flight hour [US\$/h]	15.219	18.121	18.767	19.264	37.470	18.220	18.540	36.209	17.810	18.036	35.449
Costs per block hour [US\$/h]	14.690	17.457	18.079	18.557	36.034	17.642	17.951	35.007	17.311	17.531	34.411

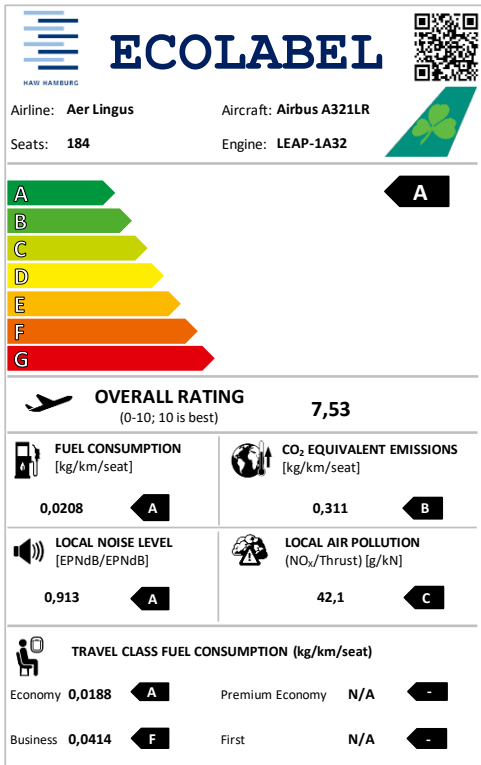
## Appendix I – FAA: Emissions and Implications

**Table I.1** Aviation-related emissions (FAA 2015)

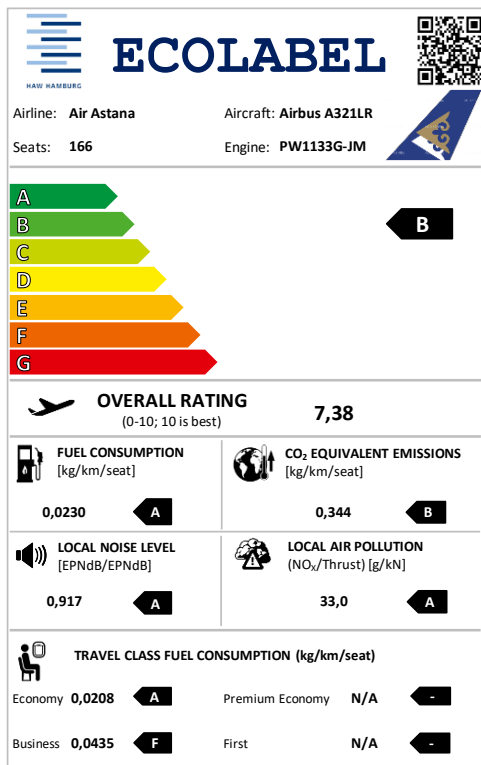
Emission product	Description	Emission source	Impacts
CO <sub>2</sub>	Carbon dioxide is the product of the complete combustion of hydrocarbon fuels. Carbon in fuel combines with oxygen in the air to produce CO <sub>2</sub> .	<ul style="list-style-type: none"> <li>• Aircraft</li> <li>• APU</li> <li>• Vehicles</li> <li>• Stationary power plants</li> </ul>	<ul style="list-style-type: none"> <li>• Climate change</li> <li>• Air Quality</li> </ul>
H <sub>2</sub> O	Water vapor is the other product of complete combustion. Hydrogen in the fuel combines with oxygen in the air to produce H <sub>2</sub> O. This is the source of water in contrails.	<ul style="list-style-type: none"> <li>• Aircraft</li> <li>• APU</li> <li>• Vehicles</li> <li>• Stationary power plants</li> </ul>	<ul style="list-style-type: none"> <li>• Climate change</li> <li>• Air Quality</li> </ul>
NO <sub>x</sub>	Nitrogen oxides are produced when air passes through high temperature/high-pressure combustion, and nitrogen and oxygen present in the air combine to form NO <sub>x</sub> . Contributes to ozone and secondary PM formation.	<ul style="list-style-type: none"> <li>• Aircraft</li> <li>• APU</li> <li>• Vehicles</li> <li>• Stationary power plants</li> </ul>	<ul style="list-style-type: none"> <li>• Climate change</li> <li>• Air Quality</li> </ul>
HC	Hydrocarbons are a result of incomplete fuel combustion. Often referred to as unburned HC (UHC) or volatile organic compounds (VOC). Contribute to ozone formation.	<ul style="list-style-type: none"> <li>• Aircraft</li> <li>• APU</li> <li>• Vehicles</li> <li>• Stationary power plants</li> </ul>	<ul style="list-style-type: none"> <li>• Climate change</li> <li>• Air Quality</li> </ul>
CH <sub>4</sub>	Methane is the most basic hydrocarbon. Commercial aircraft are net consumers of methane during the cruise and are not listed in the emissions source column. The net impact of methane from airport sources is highly dependent on local circumstances.	<ul style="list-style-type: none"> <li>• APU</li> <li>• Vehicles</li> <li>• Stationary power plants</li> </ul>	<ul style="list-style-type: none"> <li>• Climate change</li> <li>• Air Quality</li> </ul>
CO	Carbon monoxide is formed due to the incomplete combustion of the carbon in the fuel. Contributes to ozone formation.	<ul style="list-style-type: none"> <li>• Aircraft</li> <li>• Vehicles</li> </ul>	<ul style="list-style-type: none"> <li>• Climate change</li> <li>• Air Quality</li> </ul>
SO <sub>x</sub>	Sulfur oxides are produced when small quantities of sulfur, present in essentially all petroleum fuels, combine with oxygen from the air during combustion. Contributes to secondary particulate matter formation.	<ul style="list-style-type: none"> <li>• Aircraft</li> <li>• APU</li> </ul>	<ul style="list-style-type: none"> <li>• Climate change</li> <li>• Air Quality</li> </ul>
Particulate Matter	Small particles of soot that form as a result of incomplete combustion and aerosols from condensed gases, which are small enough to be inhaled	<ul style="list-style-type: none"> <li>• Aircraft</li> <li>• APU</li> <li>• Vehicles</li> <li>• Stationary power plants</li> </ul>	<ul style="list-style-type: none"> <li>• Climate change</li> <li>• Air Quality</li> </ul>



## Appendix J – Ecolabels for Other A321LR Operators



**Figure J.1** Ecolabel for the A321LR – Aer Lingus; generated with Hurtecant (2021); based on SeatGuru (2021d)

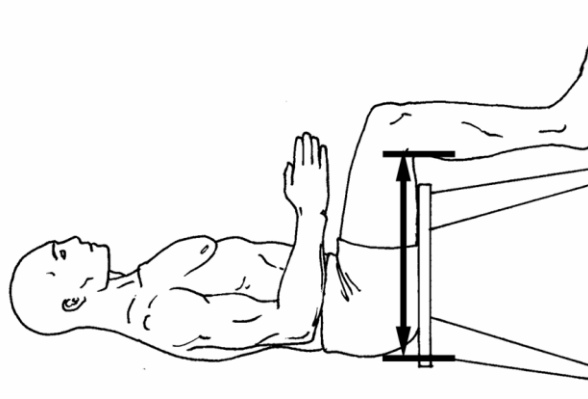


**Figure J.2** Ecolabel for the A321LR – Air Astana; generated with Hurtecant (2021); based on Air Astana (2021)

# Appendix K – Anthropometrical Data from the NCSU

Buttock-Popliteal Length

FEMALE N = 2208		MALE N = 1774	
Centimeters	Inches	Centimeters	Inches
Mean	18.96	50.04	19.70
Std Dev	1.05	2.66	1.05
Maximum	22.76	59.70	23.50
Minimum	15.51	40.10	15.79
Percentiles		Percentiles	
1 <sup>st</sup>	16.57	44.13	17.37
2 <sup>nd</sup>	16.89	44.81	17.64
3 <sup>rd</sup>	17.08	45.24	17.81
5 <sup>th</sup>	17.32	45.81	18.04
10 <sup>th</sup>	17.67	46.70	18.39
15 <sup>th</sup>	17.90	47.30	18.62
20 <sup>th</sup>	18.08	47.79	18.81
25 <sup>th</sup>	18.24	48.21	18.98
30 <sup>th</sup>	18.39	48.59	19.13
35 <sup>th</sup>	18.52	48.95	19.27
40 <sup>th</sup>	18.66	49.29	19.41
45 <sup>th</sup>	18.79	49.63	19.54
50 <sup>th</sup>	18.92	49.96	19.67
55 <sup>th</sup>	19.05	50.30	19.80
60 <sup>th</sup>	19.19	50.65	19.94
65 <sup>th</sup>	19.33	51.01	20.08
70 <sup>th</sup>	19.49	51.39	20.23
75 <sup>th</sup>	19.66	51.81	20.40
80 <sup>th</sup>	19.85	52.28	20.58
85 <sup>th</sup>	20.07	52.83	20.80
90 <sup>th</sup>	20.36	53.53	21.07
95 <sup>th</sup>	20.78	54.55	21.48
97 <sup>th</sup>	21.03	55.21	21.74
98 <sup>th</sup>	21.21	55.68	21.92
99 <sup>th</sup>	21.47	56.40	22.21



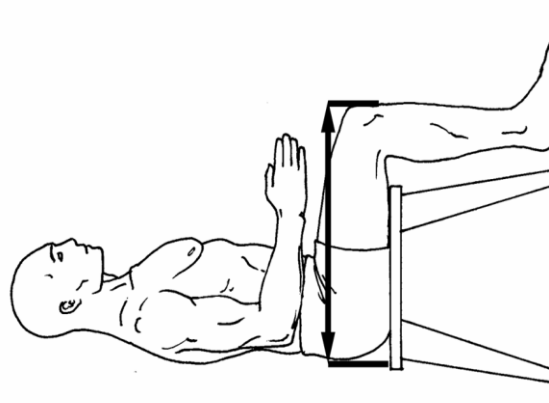
4/21/06

**Table K.1** Buttock-Popliteal Length for female and male percentiles of the American population (Ergocenter NCSU 2021)

4/21/06

**Buttock-Knee Length**

FEMALE N = 2208		MALE N = 1774	
Centimeters	Inches	Centimeters	Inches
Mean	23.19	61.64	24.27
Std Dev	1.17	2.99	1.18
Maximum	27.20	72.30	28.46
Minimum	19.33	50.60	19.92
Percentiles		Percentiles	
1 <sup>st</sup>	20.54	55.07	21.68
2 <sup>nd</sup>	20.88	55.81	21.97
3 <sup>rd</sup>	21.08	56.28	22.16
5 <sup>th</sup>	21.34	56.90	22.40
10 <sup>th</sup>	21.73	57.87	22.78
15 <sup>th</sup>	22.00	58.54	23.05
20 <sup>th</sup>	22.20	59.08	23.26
25 <sup>th</sup>	22.38	59.55	23.45
30 <sup>th</sup>	22.55	59.98	23.62
35 <sup>th</sup>	22.70	60.39	23.77
40 <sup>th</sup>	22.85	60.78	23.93
45 <sup>th</sup>	23.00	61.16	24.08
50 <sup>th</sup>	23.14	61.54	24.23
55 <sup>th</sup>	23.29	61.93	24.38
60 <sup>th</sup>	23.44	62.32	24.54
65 <sup>th</sup>	23.60	62.73	24.70
70 <sup>th</sup>	23.77	63.17	24.87
75 <sup>th</sup>	23.96	63.65	25.06
80 <sup>th</sup>	24.17	64.19	25.27
85 <sup>th</sup>	24.41	64.81	25.52
90 <sup>th</sup>	24.73	65.60	25.83
95 <sup>th</sup>	25.19	66.74	26.28
97 <sup>th</sup>	25.48	67.45	26.56
98 <sup>th</sup>	25.69	67.95	26.75
99 <sup>th</sup>	25.99	68.69	27.04



**Table K.2** Buttock-Knee Length for female and male percentiles of the American population (Ergocenter NCSU 2021)